

# 東莞永力電業有限公司

YUNG LI CO., LTD

Da Pu Industrial Zone, Gang Zi, Changping Town,  
Dong Guan City, Guangdong 523571 China.P.R.C

TEL:0769-83396797~8

FAX:0769-83396796

E-mail: sales@yung-li.com

Description: YP-21A/YC-13

Customer: MAG

Parts No. : CB-8-5M

Draw No. :

## *REVISION RECORD*

1		
2		
3		
4		
5		

YUNG LI	
CHECKED	PREPARED BY

CUSTOMER	APPROVED

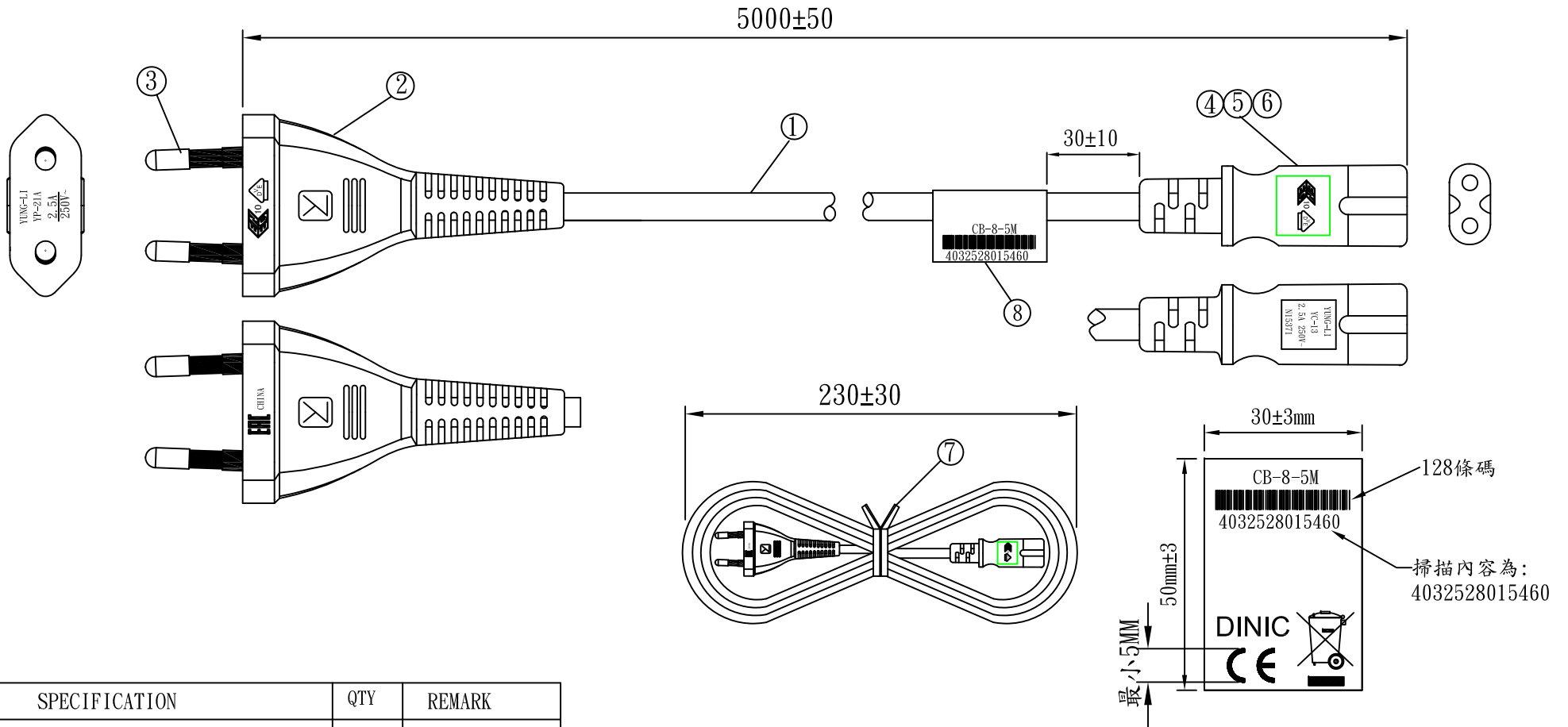
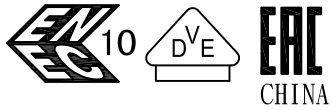

NO.	SPECIFICATION	QTY	REMARK
1	H03VVH2-F 0.75/2C BLACK	1PC	
2	YP-21A PVC PLASTIC:55P BLACK	18g/PC	
3	Europe plug inner model:P98003P-A	1PC	
4	YC-13 TER	2PCS	
5	YC-13 H. S. G	1PC	
6	YC-13 PVC PLASTIC:50P BLACK	9g/PC	
7	MINI TIE:L=150mm BLACK	1PC	
8	CORD LABEL:50X30mm 128Code	1PC	

Tolerance >0±0.30 >1.0±0.50 >10.0±1.0 >20.0±2.0 Angle: ±1°	Approved		Date		<b>YUNG LI CO.,LTD</b>			
	Checked		Date					
	Drawn	SUKI	Date	19.12.06	Customer	MAG		
	Cat. No.	YP-21A/YC-13			P/N.	CB-8-5M		
	Drawing No.	CY-V1198		Rev.	B	Material	P.V.C	Unit
					Scale			



CEE 7/16

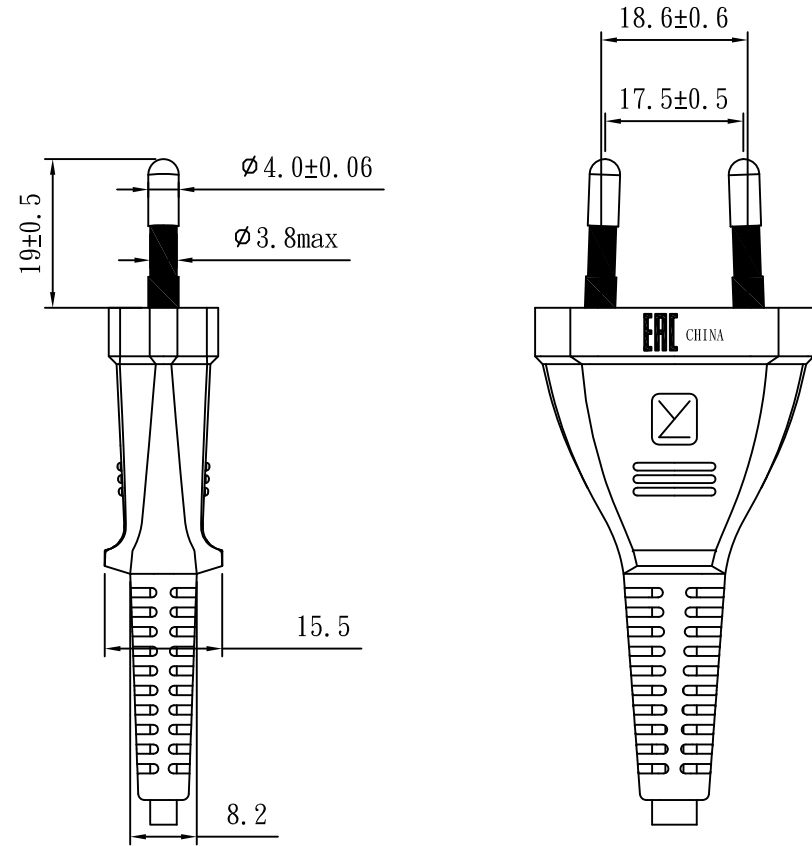
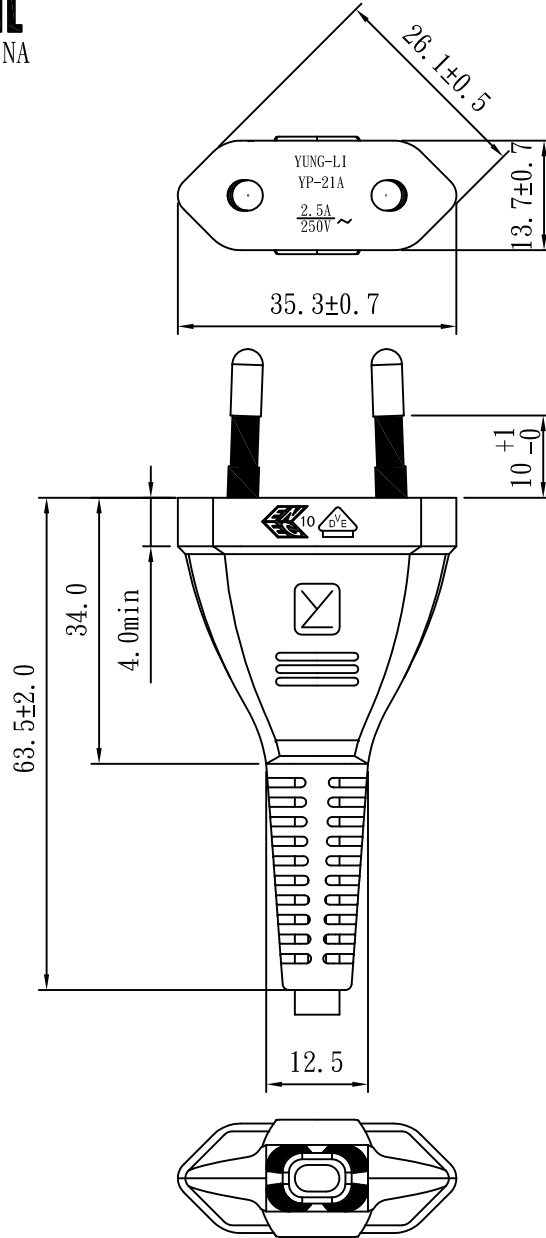

TOLERANCE $>0 \pm 0.30$ $>1.0 \pm 0.50$ $>10.0 \pm 1.0$ $>20.0 \pm 2.0$ Angle: $\pm 1^\circ$	APPROVED		DATE		YUNG LI CO., LTD			
	CHECKED		DATE					
	DRAWN		DATE					
	TYPE	YP-21A-ENEC			P/N			
DRAWING NO.	CY-P21AV			MATERIAL	P. V. C	UNIT	mm	
				SCALE	1:1			



NSW23599

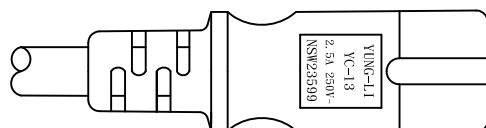
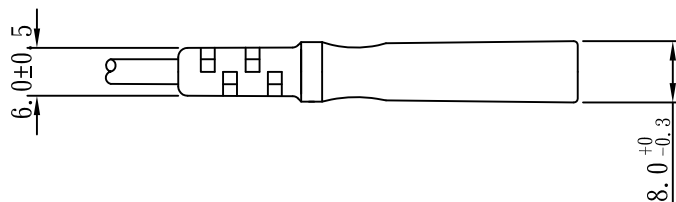
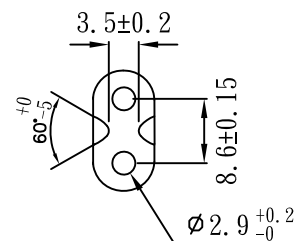
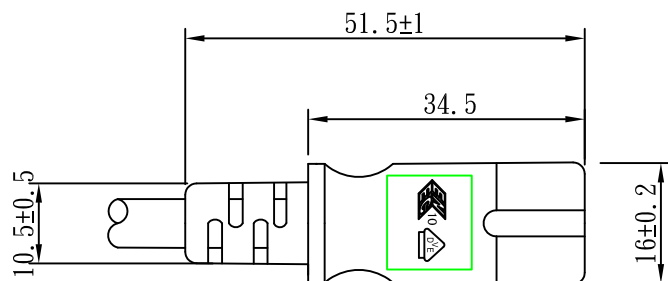

TOLERANCE >0±0.30 >1.0±0.50 >10.0±1.0 >20.0±2.0 Angle: ±1°	APPROVED		DATE		YUNG LI CO., LTD.			
	CHECKED		DATE					
	DRAWN	周淑萍	DATE	16.12.02				
	TYPE	YC-13(ENEC)			CUSTOMER			
	DRAWING NO.				MATERIAL	P. V. C	UNIT	mm
				SCALE	1:1			

# YUNG LI CO., LTD

## SPECIFICATION

Yung Li	Style	PVC FLEXIBLE CORDS	Document No
2019.04.22			CY-V04034
Edition	Size	<b>H03VVH2-F 2 x 0.75mm<sup>2</sup></b>	Page
A			1/2

1. Standard: IEC 227 IEC228

### 2. Construction & Dimension

	Item	Specification
Conductor	Size	2 x 0.75mm <sup>2</sup>
	Material	Annealed Bare Copper
	Construction	67 / $\phi$ 0.12±0.01
Insulation	Material	PVC
	Minimum Average Thickness	0.50mm
	Minimum Thickness at any point	0.35mm
	Diameter	2.15 ± 0.10
	Identification	Blue,Brown
Core Assembly	Core Twist	2-Core
	Filler	NA
	Assembly Pair	NA
Taping	Mylar Foil	NA
Shielded	A1-Mylar Foil	NA
Drain	Material	NA
	Construction	NA
Jacket	Material	PVC
	Minimum Average Thickness	0.60mm
	Minimum Thickness at any point	0.44mm
	Overall Diameter(Approx)	3.4 ± 0.1/5.6±0.15
	Color	Any Color

### Marking:

Yung Li Co., Ltd. H03VVH2-F 2X0.75mm<sup>2</sup> <VDE> NF-USE 1347 (NF) KEMA-KEUR △CEBEC <OVE>  
 (D) (FI) (N) (S) (S) IEMMEQU SAA-190646-EA (CCC) A004049 60227 IEC 52(RVV) 300/300V (K) SU01027-4001

# YUNG LI CO., LTD

## SPECIFICATION

Yung Li	Style	PVC FLEXIBLE CORDS	Document No
2019.04.22			CY-V04034
Edition	Size	<b>H03VVH2-F 2 x 0.75mm<sup>2</sup></b>	Page
A			2/2

### 3. Electrical & Physical Properties

Item	Specification		
Rating Voltage	70°C 300V		
Conductor resistance(AT 20°C)	26.0Ω/Km MAX		
Insulation Resistance(AT 70°C)	0.010MΩ/Km Min		
Dielectric Strength	AC 2.0 KV / 15 min No Break		
Spark Test	5.0KV		
Insulation	Unaged	Tensile Strength	1500 lbs/in <sup>2</sup> min
		Elongation	150% Min
	Aged	Tensile Strength	80~120% (80°C x168hrs)
		Elongation	80~120% (80°C x168hrs)
Jacket	Unaged	Tensile Strength	1500 lbs/in <sup>2</sup> min
		Elongation	150% Min
	Aged	Tensile Strength	80~120% (80°C x168hrs)
		Elongation	80~120% (80°C x168hrs)
Deformation Test	70±4°C X 1hr ≤ 50%		
Cold Bend Test	-15°C x 4hr No Crack		
Heat Shock Test	150±2°C x 1hr No Crack		

### Graph:

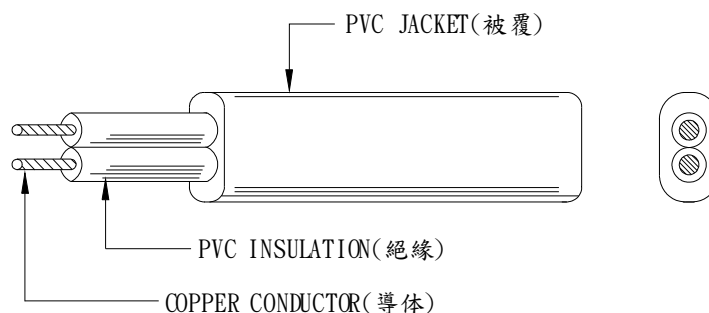

## ZEICHENGENEHMIGUNG MARKS APPROVAL

Yung-Li Co. Ltd.  
Da Pu Industrial Zone, Gang Zi  
Chang Ping Town  
523571 DONG GUAN CITY  
Guangdong  
CHINA

ist berechtigt, für ihr Produkt /  
is authorized to use for their product

**Stecker ohne Schutzkontakt, nicht wiederanschließbar, umspritzt**  
**Plug, without earthing contact, non-rewirable, moulded**

die hier abgebildeten markenrechtlich geschützten Zeichen  
für die ab Blatt 2 aufgeführten Typen zu benutzen /  
the legally protected Marks as shown below for the types referred to on page 2 ff.



Geprüft und zertifiziert nach /  
Tested and certified according to

DIN VDE 0620 Teil 101:1992-05; EN 50075:1990



Aktenzeichen: 1609800-1560-0005 / 157584

File ref.:

Ausweis-Nr. 40022312

Blatt 1

Certificate No.

Page

Weitere Bedingungen siehe Rückseite und Folgebätter /  
Further conditions see overleaf and following pages

Offenbach, 2007-10-05

(letzte Änderung/updated 2012-05-03 )

VDE Prüf- und Zertifizierungsinstitut GmbH  
VDE Testing and Certification Institute  
Zertifizierungsstelle / Certification

  
J. Gutermann

VDE Zertifikate sind nur gültig bei Veröffentlichung unter:  
VDE certificates are valid only when published on:

<http://www.vde.com/zertifikat>

<http://www.vde.com/certificate>

**VDE Prüf- und Zertifizierungsinstitut**  
**Zeichengenehmigung**

Ausweis-Nr. / Blatt /  
Certificate No. / page  
40022312 2

Name und Sitz des Genehmigungs-Inhabers / Name and registered seat of the Certificate holder

Yung-Li Co. Ltd., Da Pu Industrial Zone, Cang Zi, Chang Ping Town, 523571 DONG GUAN CITY,  
Guangdong, CHINA

Aktenzeichen / File ref.

1609800-1560-0005 / 157584 / FG45 / SHA

letzte Änderung / updated Datum / Date

2012-05-03

2007-10-05

Dieses Blatt gilt nur in Verbindung mit Blatt 1 des Zeichengenehmigungsausweises Nr. 40022312  
*This supplement is only valid in conjunction with page 1 of the Certificate No. 40022312.*

**Stecker ohne Schutzkontakt, nicht wiederanschließbar, umspritzt**  
**Plug, without earthing contact, non-rewirable, moulded**

Typ(en) / Type(s):

**YP-21A**

Bemessungsspannung  
*Rated voltage*

AC 250 V

Bemessungsstrom  
*Rated current*

2,5 A

Polzahl  
*Number of poles*

zweipolige Ausführung(en) ohne Schutzkontakt  
*two-pole version(s) without earthing contact*

Bauart  
*Kind of construction*

Normblatt 1  
*Standard sheet 1*

Schutzart  
*Degree of protection*

IP20

Produktinformation  
*Product information*

siehe Anlage Nr.: 100A  
*see Appendix No.: 100A*

Warenzeicheninhaber  
*Trademark holder*

Yung-Li Co. Ltd.

Hinweis  
*Notice*

Jedes Gerät, das mit einem Eurostecker ausgerüstet und für den Gebrauch in Großbritannien bestimmt ist, muß mit einer Warnkennzeichnung mit folgendem Inhalt ausgerüstet sein:  
*Any appliance fitted with a Europlug and intended for use in the UK shall carry a warning label stating:*

*"Within the UK, this appliance may only be used when supplied from a shaver supply unit in accordance with EN 61558-2-5 and must not be connected to a UK mains socket."*

Fortsetzung siehe Blatt 3 /  
*continued on page 3*









## СЕРТИФИКАТ СООТВЕТСТВИЯ

№ ТС BY/112 02.01. 020 04363Серия ВУ № 0040721

## ОРГАН ПО СЕРТИФИКАЦИИ

Открытое акционерное общество «Испытания и сертификация бытовой и промышленной продукции «БЕЛЛИС»; юридический адрес: Республика Беларусь, 220029, г. Минск, ул. Красная, 7Б; фактический адрес: Республика Беларусь, 220029, г. Минск, ул. Красная, 8; тел. +375 17 288 16 41; факс +375 17 288 16 41; e-mail: bellis@bellis.by; аттестат аккредитации № BY/112.020.02 от 22.03.2011, Республиканское унитарное предприятие «Белорусский государственный центр аккредитации».

## ЗАЯВИТЕЛЬ

Yung Li Co., Ltd.  
юридический адрес: Da Pu Industrial Zone, Chang Ping Town, Dong Guan City, Guang Dong, 523571, Китай;  
фактический адрес: Da Pu Industrial Zone, Chang Ping Town, Dong Guan City, Guang Dong, 523571, Китай;  
телефон: +86-769-83335989; факс: +86-769-83396796; e-mail: eng@yung-li.com

## ИЗГОТОВИТЕЛЬ

Yung Li Co., Ltd., Da Pu Industrial Zone, Chang Ping Town, Dong Guan City, Guang Dong, 523571, Китай

## ПРОДУКЦИЯ

вилка опресованная тип YP-21A

серийный выпуск

КОД ТН ВЭД ТС 8544 42 290 0

## СООТВЕТСТВУЕТ ТРЕБОВАНИЯМ

Технический регламент Таможенного союза «О безопасности низковольтного оборудования»  
ТР ТС 004/2011; ГОСТ Р 51322.1-2011.

## СЕРТИФИКАТ ВЫДАН НА ОСНОВАНИИ

протокола аккредитованной испытательной лаборатории «БЕЛЛИС», BY/112 02.1.0.0001,  
№№ 101-15-0369 от 25.02.2015;  
отчета о проверке производства от 05.11.2014.

## ДОПОЛНИТЕЛЬНАЯ ИНФОРМАЦИЯ

СРОК ДЕЙСТВИЯ С 27.02.2015 ПО 26.02.2020 ВКЛЮЧИТЕЛЬНО



Руководитель (уполномоченное  
лицо) органа по сертификации

Эксперт (эксперт-аудитор)  
(эксперты (эксперты-аудиторы))

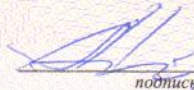
  
подпись

А.Г. Раковский  
инициалы, фамилия

  
подпись

А.В. Сиводед  
инициалы, фамилия



## ZEICHENGENEHMIGUNG MARKS APPROVAL

Yung-Li Co. Ltd.  
Da Pu Industrial Zone, Cang Zi  
Chang Ping Town  
523571 DONG GUAN CITY  
Guangdong  
CHINA

ist berechtigt, für ihr Produkt /  
*is authorized to use for their product*

**Gerätesteckdose, nicht-wiederanschließbar**  
**Connector, non-rewirable**

die hier abgebildeten markenrechtlich geschützten Zeichen  
für die ab Blatt 2 aufgeführten Typen zu benutzen /  
*the legally protected Marks as shown below for the types referred to on page 2 ff.*



Geprüft und zertifiziert nach /  
*Tested and certified according to*

DIN EN 60320-1 (VDE 0625-1):2016-04; EN 60320-1:2015+AC:2016  
DIN EN 60320-3 (VDE 0625-3):2015-11; EN 60320-3:2014  
IEC 60320-1:2015  
IEC 60320-3:2014



Aktenzeichen: 1609800-1550-0005 / 232749

File ref.:

Ausweis-Nr. 40029072

Blatt 1

Certificate No.

Page

Weitere Bedingungen siehe Rückseite und Folgeblätter /  
*further conditions see overleaf and following pages*

Offenbach, 2010-01-08

(letzte Änderung/updated 2017-10-19 )

VDE Prüf- und Zertifizierungsinstitut GmbH  
VDE Testing and Certification Institute  
Zertifizierungsstelle / Certification

R. Nickel

VDE Zertifikate sind nur gültig bei Veröffentlichung unter:  
VDE certificates are valid only when published on:

<http://www.vde.com/zertifikat>  
<http://www.vde.com/certificate>

Name und Sitz des Genehmigungs-Inhabers / *Name and registered seat of the Certificate holder*

Yung-Li Co. Ltd., Da Pu Industrial Zone, Cang Zi, Chang Ping Town, 523571 DONG GUAN CITY, Guangdong, CHINA

Aktenzeichen / *File ref.*

1609800-1550-0005 / 232749 / CC1 / E

letzte Änderung / *updated*

2017-10-19

Datum / *Date*

2010-01-08

Dieses Blatt gilt nur in Verbindung mit Blatt 1 des Zeichengenehmigungsausweises Nr. 40029072.

*This supplement is only valid in conjunction with page 1 of the Certificate No. 40029072.*

## Gerätesteckdose, nicht-wiederanschließbar *Connector, non-rewirable*

Typ(en) / *Type(s)*

- 1) YC-13
- 2) YC-13L
- 3) YC-13D

Bemessungsspannung  
*Rated voltage*

AC 250 V

Bemessungsstrom  
*Rated current*

2,5 A

Polzahl  
*Number of poles*

2-polig ohne Schutzkontakt  
*2-pole without earthing contact*

Bauart  
*Kind of construction*

Normblatt C7  
*standard sheet C7*

Ausführung(en)  
*Construction(s)*

zentrale Leitungseinführung  
*straight cable entry*  
Für / *for* 1)

abgewinkelte Leitungseinführung  
*angled cable entry*  
Für / *for* 2), 3)

Warenzeicheninhaber  
*Trademark holder*

Yung-Li Co. Ltd.

Anmerkung(en)

Gerätesteckdosen ohne Schutzkontakt müssen Teil einer Geräteanschlußleitung oder einer Weiterverbindungs-Geräteanschlußleitung sein

*Remark(s)*

*Connectors without earthing contact shall be part of a cord set or interconnection cord set*

Produktinformation  
*Product information*

siehe Anlage Nr. 300 + 700 + 900 vom 2017-10-19  
*see Appendix No. 300 + 700 + 900 dated 2017-10-19*

Fortsetzung siehe Blatt 3 /  
*continued on page 3*

# VDE Prüf- und Zertifizierungsinstitut Zeichengenehmigung

Ausweis-Nr. / Blatt /  
Certificate No. / Page  
40029072 3

Name und Sitz des Genehmigungs-Inhabers / *Name and registered seat of the Certificate holder*

Yung-Li Co. Ltd., Da Pu Industrial Zone, Cang Zi, Chang Ping Town, 523571 DONG GUAN CITY, Guangdong, CHINA

Aktenzeichen / *File ref.*

1609800-1550-0005 / 232749 / CC1 / E

letzte Änderung / *updated*

2017-10-19

Datum / *Date*

2010-01-08

Dieses Blatt gilt nur in Verbindung mit Blatt 1 des Zeichengenehmigungsausweises Nr. 40029072.

*This supplement is only valid in conjunction with page 1 of the Certificate No. 40029072.*

Dieser Zeichengenehmigungs-Ausweis bildet eine Grundlage für die EG-Konformitätserklärung und CE-Kennzeichnung durch den Hersteller oder dessen Bevollmächtigten und bescheinigt die Konformität mit den grundlegenden Schutzanforderungen der **EG-Niederspannungsrichtlinie 2014/35/EU**.

*This Marks Approval is a basis for the EC Declaration of Conformity and the CE Marking by the manufacturer or his agent and proves the conformity with the essential safety requirements of the **EC Low-Voltage Directive 2014/35/EU**.*

VDE Prüf- und Zertifizierungsinstitut GmbH

*VDE Testing and Certification Institute*

Fachgebiet CC1

*Section CC1*

# VDE Prüf- und Zertifizierungsinstitut Zeichengenehmigung

Ausweis-Nr. / Beiblatt /  
Certificate No. Supplement  
40029072

Name und Sitz des Genehmigungs-Inhabers / *Name and registered seat of the Certificate holder*

Yung-Li Co. Ltd., Da Pu Industrial Zone, Cang Zi, Chang Ping Town, 523571 DONG GUAN CITY, Guangdong, CHINA

Aktenzeichen / *File ref.*

1609800-1550-0005 / 232749 / CC1 / E

letzte Änderung / *updated*

2017-10-19

Datum / *Date*

2010-01-08

Dieses Beiblatt ist Bestandteil des Zeichengenehmigungsausweises Nr. 40029072.

*This supplement is part of the Certificate No. 40029072.*

## Gerätesteckdose, nicht-wiederanschließbar *Connector, non-rewirable*

### Fertigungsstätte(n)

*Place(s) of manufacture*

Referenz/*Reference*  
**30008928**

Yung-Li Co. Ltd.  
Da Pu Industrial Zone, Cang Zi  
Chang Ping Town  
523571 DONG GUAN CITY  
Guangdong  
CHINA

VDE Prüf- und Zertifizierungsinstitut GmbH  
*VDE Testing and Certification Institute*  
Fachgebiet CC1  
*Section CC1*





Certificate Number: 23599

# CERTIFICATE OF APPROVAL

ISSUED PURSUANT TO THE ELECTRICITY (CONSUMER SAFETY) ACT 2004

**ISSUED TO:**

Yung Li Co Ltd

**CLASS OF ARTICLE:**

Appliance Connector

**DESCRIPTION OF ARTICLE:**

Appliance Connector  
(Non-rewirable, thermoplastic moulded, straight-entry C7 appliance connector for cold conditions for Class II equipment integrally moulded to any <HAR> certified H03VVH2-F 2X0.75mm<sup>2</sup> or Australian approved, two-core, 0.75mm<sup>2</sup>, PVC insulated and sheathed light duty flat flexible cord)  
Trade Name: 'Yung Li'  
250V, ac 2.5A

**EXAMINED FOR COMPLIANCE WITH:** AS/NZS 60320.1 : 2004

**TYPE REFERENCE CODE:** Type YC-13

**APPROVAL MARK:**

Each electrical article of the abovementioned type shall be marked with Approval Number NSW23599 or N15371 ;or  
the Regulatory Compliance Mark (RCM) provided that the requirements of all relevant parts of AS/NZS 4417 applicable to the article are fulfilled.

**DATE OF APPROVAL:** 30 July 2008

This approval expires 30 July 2013 unless suspended, cancelled, renewed or extended.



for Commissioner for Fair Trading



ADDENDUM TO CERTIFICATE OF APPROVAL 23599

Particulars of Modification(s)

1. Type No. YC-13 alternatively moulded to any of the following <HAR> certified or equivalent Australian approved flexible cords:-
  - (a) H05VVH2-F 2X0.75mm<sup>2</sup>,
  - (b) H03VV-F 2X0.75mm<sup>2</sup>,
  - (c) H05VV-F 2X0.75mm<sup>2</sup>,
  
2. Type No. YC-13L being similar to Type No. YC-13 except having a side cord entry on the vertical plane in lieu of a rear cord entry and integrally moulded to any of the following <HAR> certified or equivalent Australian approved flexible cords:-
  - (a) H03VVH2-F 2X0.75mm<sup>2</sup>,
  - (b) H05VVH2-F 2X0.75mm<sup>2</sup>,
  - (c) H03VV-F 2X0.75mm<sup>2</sup>,
  - (d) H05VV-F 2X0.75mm<sup>2</sup>,
  
3. Type No. YC-13D being similar to Type No. YC-13 except having a side cord entry on the horizontal plane in lieu of a rear cord entry and integrally moulded to any of the following <HAR> certified or equivalent Australian approved flexible cords:-
  - (a) H03VVH2-F 2X0.75mm<sup>2</sup>,
  - (b) H05VVH2-F 2X0.75mm<sup>2</sup>,
  - (c) H03VV-F 2X0.75mm<sup>2</sup>,
  - (d) H05VV-F 2X0.75mm<sup>2</sup>,

Approved: 30 July 2008



for Commissioner for Fair Trading



Fair  
Trading

Ref: NSW23599/2

## RENEWAL OF CERTIFICATE OF APPROVAL: NSW23599

### Particulars of Renewal

The approval of (C7) Appliance Connector Type No. YC-13 and all approved modifications has been renewed for a period of FIVE years.

The Approval expires on 30/07/2018 unless it is renewed, extended, suspended or cancelled.

 12/6/2013

For Commissioner for Fair Trading



Fair  
Trading

Ref: NSW23599/3

## RENEWAL OF CERTIFICATE OF APPROVAL: NSW23599

### Particulars of Renewal

The approval of (C7) Appliance Connector Type No. YC-13 and all approved modifications has been renewed for a period of FIVE years.

The Approval expires on 30/07/2023 unless it is renewed, extended, suspended or cancelled.

For Commissioner for Fair Trading

# VDE Prüf- und Zertifizierungsinstitut

## ZEICHENGENEHMIGUNG MARKS APPROVAL

Yung-Li Co. Ltd.  
Da Pu Industrial Zone, Cang Zi  
Chang Ping Town  
523571 DONG GUAN CITY  
Guangdong  
CHINA

ist berechtigt, für ihr Produkt /  
is authorized to use for their product

Flexible Leitung  
Flexible cable (cord)

die hier abgebildeten markenrechtlich geschützten Zeichen  
für die ab Blatt 2 aufgeführten Typen zu benutzen /  
the legally protected Marks as shown below for the types referred to on page 2 ff.



Geprüft und zertifiziert nach /  
Tested and certified according to

DIN VDE 0281-5 (VDE 0281 Teil 5):2002-09; HD 21.5 S3:1994 + A1:1999 + A2:2001

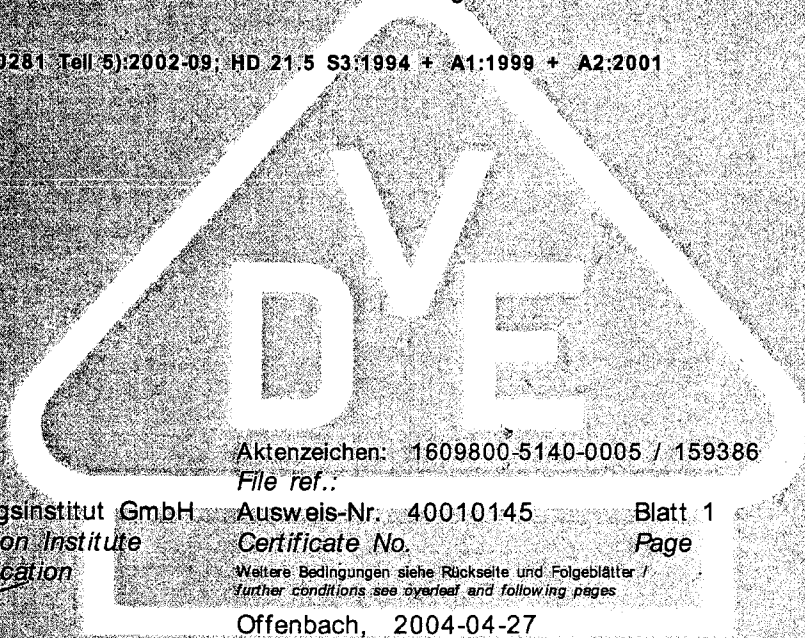

Aktenzeichen: 1609800-5140-0005 / 159386  
File ref..

VDE Prüf- und Zertifizierungsinstitut GmbH  
VDE Testing and Certification Institute  
Zertifizierungsstelle / Certification

Ausweis-Nr. 40010145 Blatt 1  
Certificate No. Page

Weitere Bedingungen siehe Rückseite und Folgeblätter /  
further conditions see overleaf and following pages

Offenbach, 2004-04-27  
(letzte Änderung/updated 2012-03-27 )

K. Prohaska

VDE Zertifikate sind nur gültig bei Veröffentlichung unter:  
VDE certificates are valid only when published on:

<http://www.vde.com/zertifikat>  
<http://www.vde.com/certificate>

# VDE



# VDE Prüf- und Zertifizierungsinstitut Zeichengenehmigung

Ausweis-Nr. / Blatt /  
Certificate No. page  
40010145 2

Name und Sitz des Genehmigungs-Inhabers / *Name and registered seat of the Certificate holder*  
Yung-Li Co. Ltd., Da Pu Industrial Zone, Cang Zi, Chang Ping Town, 523571 DONG GUAN CITY,  
Guangdong, CHINA

Aktenzeichen / *File ref.*  
1609800-5140-0005 / 159386 / FG42 / STR

letzte Änderung / *updated* Datum / *Date*  
2012-03-27 2004-04-27

Dieses Blatt gilt nur in Verbindung mit Blatt 1 des Zeichengenehmigungsausweises Nr. 40010145  
*This supplement is only valid in conjunction with page 1 of the Certificate No. 40010145.*

## Flexible Leitung *Flexible cable (cord)*

Typ(en) / *Type(s)*:

H03VV-F 2...4 x 0,5...0,75 mm <sup>2</sup>	+
H03VVH2-F 2 x 0,5...0,75 mm <sup>2</sup>	+
H05VV-F 2...5 x 0,75...4 mm <sup>2</sup>	+
H05VVH2-F 2 x 0,75...1,0 mm <sup>2</sup>	+

Firmenzeichen YUNG LI  
*Trademark*

Dieser Zeichengenehmigungs-Ausweis bildet eine Grundlage für die EG-Konformitätserklärung und CE-Kennzeichnung durch den Hersteller oder dessen Bevollmächtigten und bescheinigt die Konformität mit den grundlegenden Schutzanforderungen der **EG-Niederspannungsrichtlinie 2006/95/EG** mit ihren Änderungen.

*This Marks Approval is a basis for the EC Declaration of Conformity and the CE Marking by the manufacturer or his agent and proves the conformity with the essential safety requirements of the EC Low-Voltage Directive 2006/95/EC including amendments.*

VDE Prüf- und Zertifizierungsinstitut GmbH  
*VDE Testing and Certification Institute*  
Fachgebiet FG42  
*Section FG42*