

# 東莞永力電業有限公司

YUNG LI CO., LTD

Da Pu Industrial Zone, Gang Zi, Changping Town,  
Dong Guan City, Guangdong 523571 China.P.R.C

TEL:0769-83396797~8

F AX:0769-83396796

E-mail: sales@yung-li.com

Description : YP-44/[ E'34

Customer : \_SY

Parts No. : ED/P/70

Draw No. : E[ /X2493

## REVISION RECORD

1		
2		
3		
4		
5		

YUNG LI	
CHECKED	PREPARED BY
蔣彥宏*	周淑萍



CUSTOMER APPROVED	
CHECKED	PREPARED BY



No advice if add any approval marks on this POWER CORD

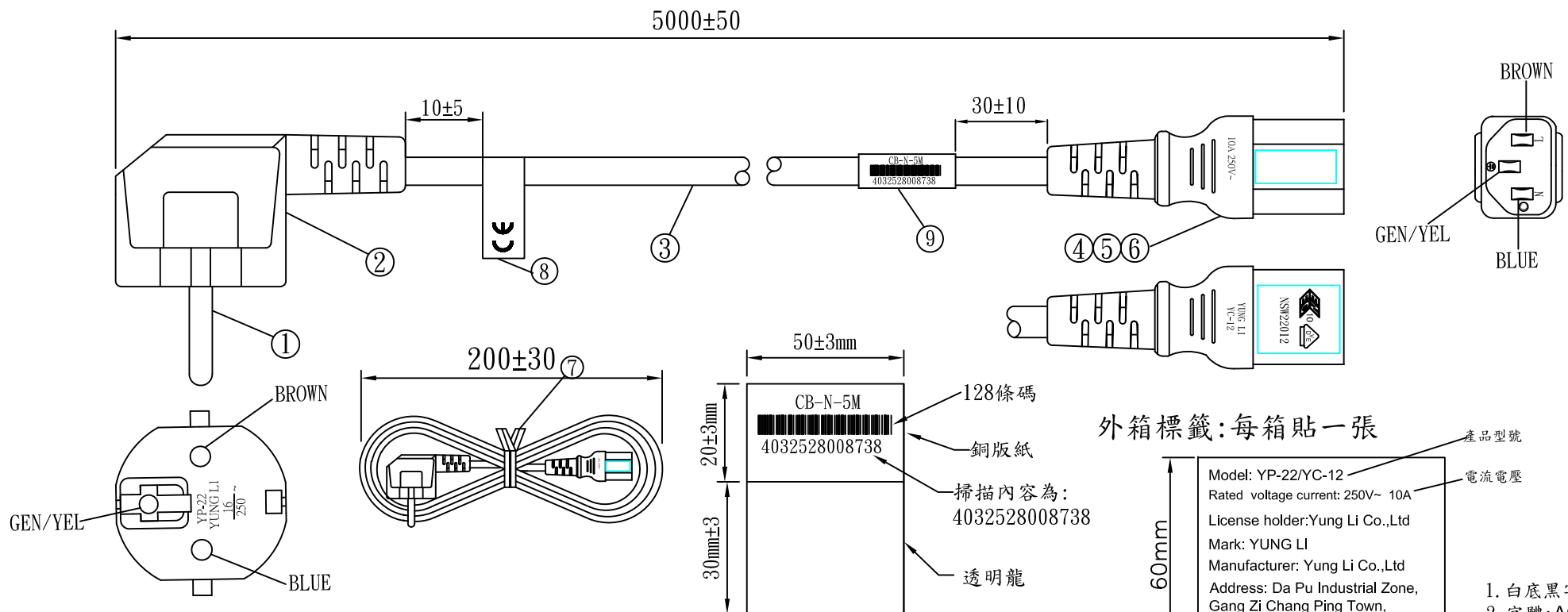

外箱標籤:每箱貼一張

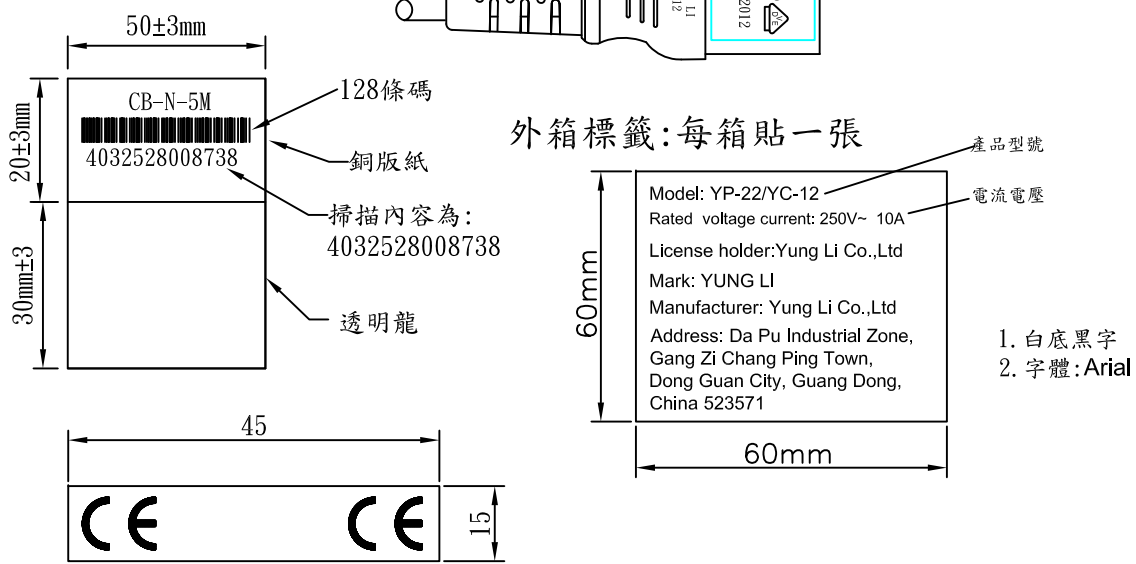

NO.	SPECIFICATION	Q' TY	REMARK
1	Euro plug inner model:98651	1PC	
2	YP-22 PVC PLASTIC:50P BLACK	34g/PC	
3	H05VV-F 1.0/3G BLACK	1PC	5000±20(YL)
4	TER:97740	3PCS	
5	YC-12 INNER BODY	1PC	
6	YC-12 PVC PLASTIC:50P BLACK	18g/PC	
7	MINI TIE:L=180mm BLACK	1PC	
8	LABEL:45x15mm	1PC	Label-4144
9	LABEL:(30+20)X50mm 128碼	1PC	Label-6713
10	LABEL:60*60mm	1PC	包裝打印

TOLERANCE >0±0.30 >1.0±0.50 >10.0±1.0 >20.0±2.0 Angle: ±1°	APPROVED	DATE	YUNG LI CO., LTD			
	CHECKED	DATE				
DRAWN	陳守瑞	DATE	17.10.17	CUSTOMER	MAG	
TYPE	YP-22/YC-12		P/N	CB-N-5M		
DRAWING NO. CY-V0271	REV	H	MATERIAL	P.V.C	UNIT	mm
			SCALE			

1. 白底黑字
2. 字體: Arial



1532AP

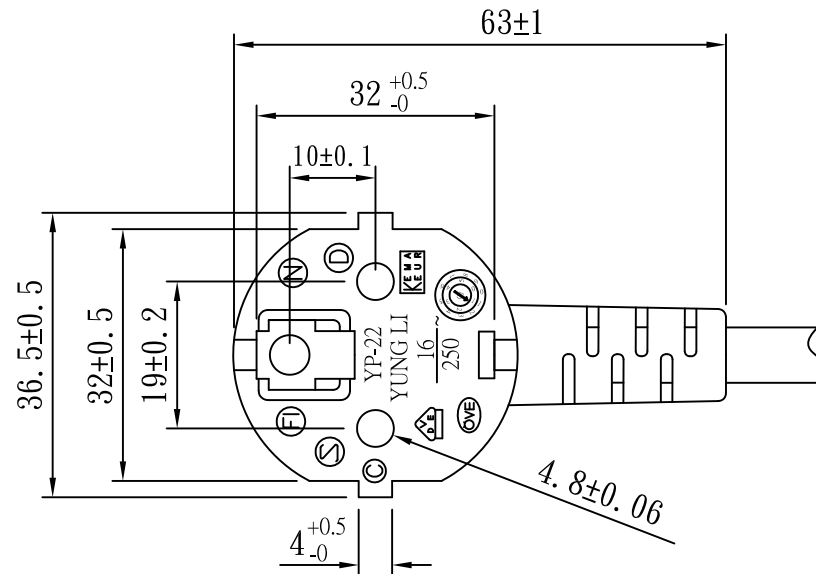
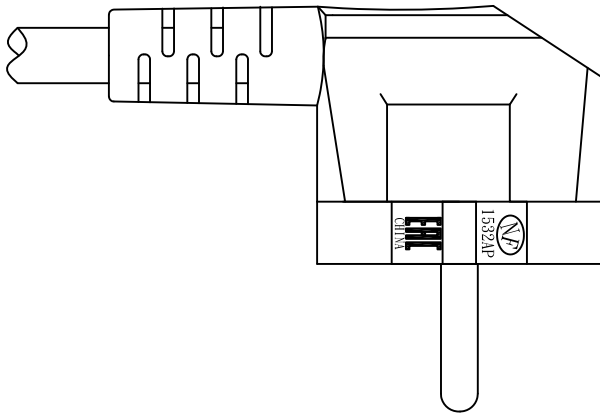
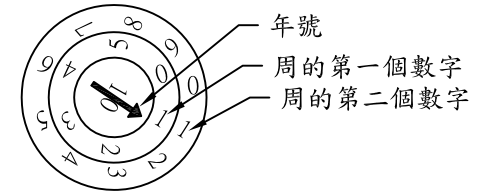
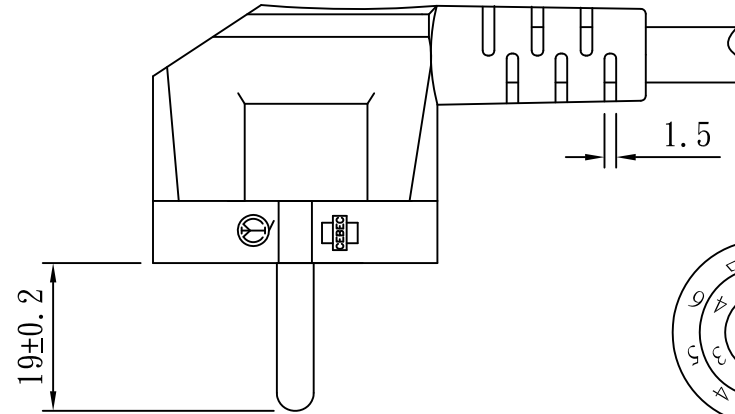
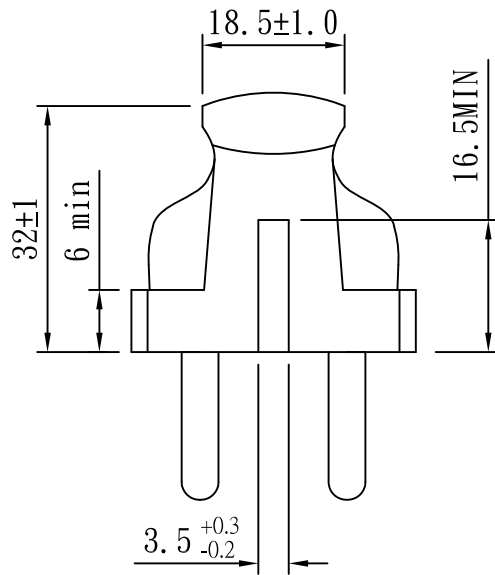

TOLERANCE >0±0.30 >1.0±0.50 >10.0±1.0 >20.0±2.0 Angle: ±1°	APPROVED		DATE		YUNG LI CO., LTD.			
	CHECKED		DATE					
	DRAWN		DATE					
	TYPE	YP-22			P/N			
	DRAWING NO				MATERIAL	P.V.C	UNIT	mm
					SCALE	1:1		



NSW22012

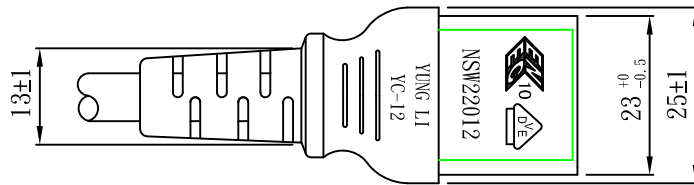
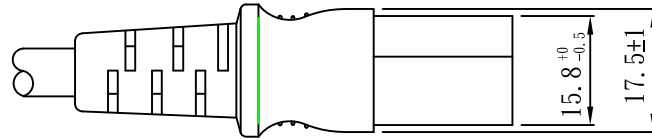
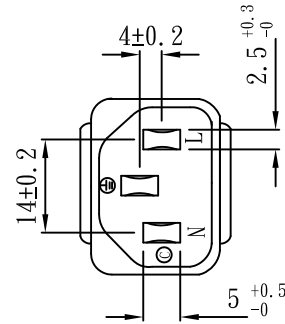
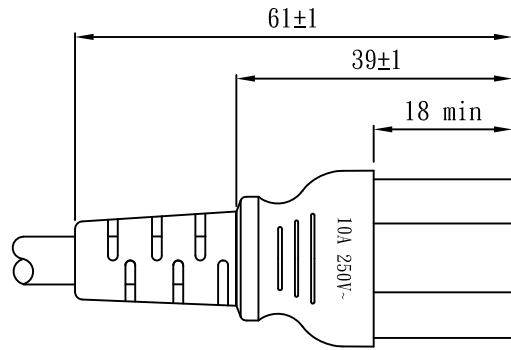

TOLERANCE >0±0.30 >1.0±0.50 >10.0±1.0 >20.0±2.0 Angle: ±1°	APPROVED		DATE		YUNG LI CO., LTD			
	CHECKED		DATE					
	DRAWN		DATE		CUSTOMER			
	TYPE	YC-12(ENEC)			P/N			
	DRAWING NO.	CY-C12V10A250VB	REV	B	SCALE	1:1	UNIT	mm

# YUNG LI CO., LTD

## SPECIFICATION









Yung Li	Style	PVC FLEXIBLE CORDS	Document No
2012.7.18			YL-V01004
Edition	Size	<b>H05VV-F 3G 1.0mm<sup>2</sup></b>	Page
A			1/2

1. Standard: IEC 60227 IEC 60228

2. Construction & Dimension

	Item	Specification
Conductor	Size	3G 1.0mm <sup>2</sup>
	Material	Annealed Bare Copper
	Construction	32/ § 0.202±0.005
Insulation	Material	PVC
	Minimum Average Thickness	0.60mm
	Minimum Thickness at any point	0.48mm
	Diameter	2.50 ± 0.10
	Identification	Blue,Brown,Yellow/Green
Core Assembly	Core Twist	3-Core
	Filler	NA
	Assembly Pair	NA
Taping	Mylar Foil	NA
Shielded	A1-Mylar Foil	NA
Drain	Material	NA
	Construction	NA
Jacket	Material	NA
	Minimum Average Thickness	0.8mm
	Minimum Thickness at any point	0.58mm
	Overall Diameter(Approx)	7.0± 0.15
	Color	Any Color

### Marking:

Yung Li Co., Ltd. H05VV-F 3G 1.0mm<sup>2</sup> <VDE> NF-USE 1347  KEMA-KEUR  CEBEC <ÖVE>  
     IEMMEQU ES0140750  A004049 60227 IEC 53(RVV) 300/500V  SU01027-4002

# YUNG LI CO., LTD

## SPECIFICATION

Yung Li	Style	PVC FLEXIBLE CORDS	Document No
2012.7.18			YL--V01004
Edition	Size	<b>H05VV-F 3G 1.0mm<sup>2</sup></b>	Page
A			2/2

### 4. Electrical & Physical Properties

Item	Specification		
Rating Voltage	300/500V		
Maximum Temperature Rating	70°C		
Conductor resistance(AT 20°C)	19.5Ω/Km MAX		
Insulation Resistance(AT 70°C)	0.010MΩ · Km Min		
Dielectric Strength	AC 2.0 KV / 15 min No Break		
Spark Test	5.0KV		
Insulation	Unaged	Tensile Strength	1.02 kgf/mm <sup>2</sup> min
		Elongation	150% Min
	Aged	Tensile Strength	80~120% (80°C x 168hrs)
		Elongation	80~120% (80°C x 168hrs)
	Loss of mass Test		2.0mg/cm <sup>2</sup> (max)
Jacket	Unaged	Tensile Strength	1.02 kgf/mm <sup>2</sup> min
		Elongation	150% Min
	Aged	Tensile Strength	80~120% (80°C x 168hrs)
		Elongation	80~120% (80°C x 168hrs)
	Loss of mass Test		2.0mg/cm <sup>2</sup> (max)
Deformation Test		70±4°C X 1hr ≤ 50%	
Cold Bend Test		-15°C x 4hr No Crack	
Heat Shock Test		150±2°C x 1hr No Crack	

Graph:

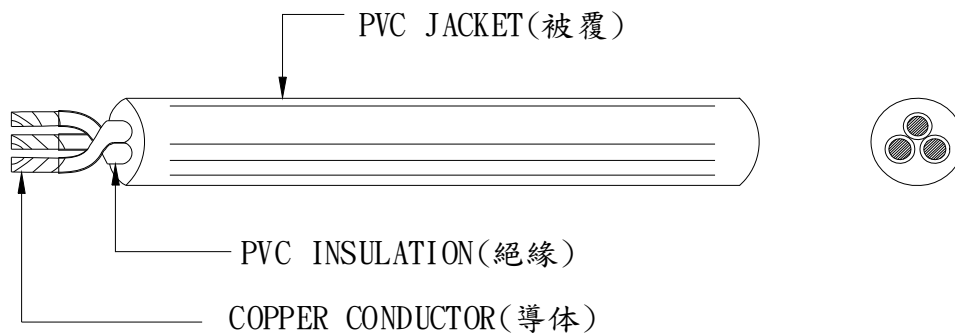

## ZEICHENGENEHMIGUNG MARKS APPROVAL

Yung-Li Co. Ltd.  
Da Pu Industrial Zone, Cang Zi  
Chang Ping Town  
523571 DONG GUAN CITY  
Guangdong  
CHINA

ist berechtigt, für ihr Produkt /  
*is authorized to use for their product*

**Stecker mit Schutzkontakt, nicht wiederanschließbar, umspritzt**  
***Plug, with earthing contact, non-rewirable, moulded***

die hier abgebildeten markenrechtlich geschützten Zeichen  
für die ab Blatt 2 aufgeführten Typen zu benutzen /  
*the legally protected Marks as shown below for the types referred to on page 2 ff.*



Geprüft und zertifiziert nach /  
*Tested and certified according to*

DIN VDE 0620-2-1 (VDE 0620-2-1):2013-03

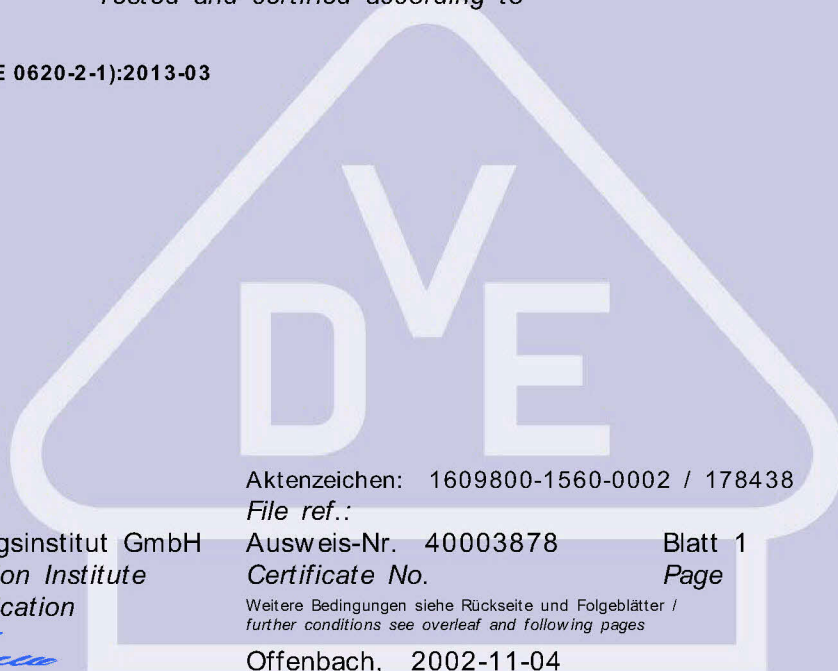

VDE Prüf- und Zertifizierungsinstitut GmbH  
*VDE Testing and Certification Institute*  
Zertifizierungsstelle / *Certification*

*J. Gütermann*  
J. Gütermann

VDE Zertifikate sind nur gültig bei Veröffentlichung unter:  
*VDE certificates are valid only when published on:*

Aktenzeichen: 1609800-1560-0002 / 178438

*File ref.:*

Ausweis-Nr. 40003878

*Certificate No.*

Blatt 1

*Page*

Weitere Bedingungen siehe Rückseite und Folgeblätter /  
*further conditions see overleaf and following pages*

Offenbach, 2002-11-04

(letzte Änderung/updated 2013-05-13 )

<http://www.vde.com/zertifikat>

<http://www.vde.com/certificate>

Name und Sitz des Genehmigungs-Inhabers / *Name and registered seat of the Certificate holder*  
Yung-Li Co. Ltd., Da Pu Industrial Zone, Cang Zi, Chang Ping Town, 523571 DONG GUAN CITY,  
Guangdong, CHINA

Aktenzeichen / *File ref.*  
1609800-1560-0002 / 178438 / CC1 / SHA

letzte Änderung / *updated* Datum / *Date*  
2013-05-13 2002-11-04

Dieses Blatt gilt nur in Verbindung mit Blatt 1 des Zeichengenehmigungsausweises Nr. 40003878  
*This supplement is only valid in conjunction with page 1 of the Certificate No. 40003878.*

**Stecker mit Schutzkontakt, nicht wiederanschließbar, umspritzt**  
**Plug, with earthing contact, non-rewirable, moulded**

Typ(en) / *Type(s)*:

**YP-22**

Bemessungsspannung <i>Rated voltage</i>	AC 250 V
Bemessungsstrom <i>Rated current</i>	16 A
Polzahl <i>Number of poles</i>	2-polig mit zwei Schutzkontaktsystemen <i>2-pole with two earthing contact systems</i>
Bauart <i>Kind of construction</i>	DIN 49441-R2
Schutzart <i>Degree of protection</i>	IP20
Produktinformation <i>Product information</i>	siehe Anlage Nr. 400A + 401A + 900A <i>see Appendix No. 400A + 401A + 900A</i>

---

VDE Prüf- und Zertifizierungsinstitut GmbH  
*VDE Testing and Certification Institute*  
Abteilung CC1  
*Section CC1*



**OVE AUSTRIAN ELECTROTECHNICAL ASSOCIATION**

Eschenbachgasse 9, 1010 Wien, Austria  
ZVR: 327279890 | DVR: 1055887



**OVE - Testing & Certification**

Kahlenberger Str. 2A, 1190 Wien, Austria  
Phone: +43 1 370 58 06  
www.ove.at

Page 1 of 2

# ÖVE-CERTIFICATE

including the entitlement to use the Austrian Safety Mark



Certificate No.: **21721-006-05**

Valid from: 2017 02 17  
until: 2019 02 17

The Austrian Electrotechnical Association (OVE) hereby grants the right to the company mentioned below to label the listed products with the Austrian Safety Mark.

Company: **Yung Li Co. Ltd.**  
Da Pu Industrial Zone, Gang Zi, Chang Ping Town  
523571 Dong Guan City, Guang Dong Province  
China

Product: **Non rewirable two pole plug with dual earthing system**

The products submitted by the applicant were type tested in accordance with the requirements of the technical standards and specifications listed in this certificate. OVE certifies the conformity of the listed products and those products manufactured strictly identical to the submitted ones (ISO/IEC 17067, Conformity Assessment Scheme Type 5).

The manufacturing process and the products are subject to ongoing surveillance based on harmonized European procedures. This certificate has been issued under the presumption and conditional on the fact that the applicant holds all necessary legal rights with regard to the product, presented for the testing and certification.

Results of testing are shown in file No(s): **1740-1182/03**

**Österreichischer Verband für Elektrotechnik**  
Head of Testing & Certification



Digitally signed by W. Martin  
Email=w.martin@ove.at

Dipl.-Ing. W. Martin

Vienna, 2017 02 15

**OVE - Testing & Certification**

Accredited by the Federal Ministry of Science, Research and Economy as Certification Body for products within the scope as given in the official decree and published under [www.en.bmwf.gv.at/accreditation](http://www.en.bmwf.gv.at/accreditation)





**Manufacturer:**

Yung Li Co. Ltd.  
Da Pu Industrial Zone, Gang Zi, Chang Ping Town  
523571 Dong Guan City, Guang Dong Province  
China

**Factory location(s):**

Yung Li Co. Ltd.  
Da Pu Industrial Zone, Gang Zi, Chang Ping Town  
523571 Dong Guan City, Guang Dong Province  
China

**Tested and certified according to:**

ÖVE/ÖNORM IEC 60884-1:2005-09-01

**Product: Non rewirable two pole plug with dual earthing system**

**Type designation:**  
*Rating:*

**Trademark:**

**YP-22**

Rated voltage: AC 250 V  
Rated current: 16 A  
H03VV-F 3 G 0,75

YUNG LI

**YP-22**

Rated voltage: AC 250 V  
Rated current: 16 A  
H05VV-F 3 G 0,75

YUNG LI

**YP-22**

Rated voltage: AC 250 V  
Rated current: 16 A  
H05VV-F 3 G 1

YUNG LI

**YP-22**

Rated voltage: AC 250 V  
Rated current: 16 A  
H05VV-F 3 G 1,5

YUNG LI

**OVE - Testing & Certification**

Accredited by the Federal Ministry of Science, Research and Economy as Certification Body for products within the scope as given in the official decree and published under [www.en.bmwf.gv.at/accreditation](http://www.en.bmwf.gv.at/accreditation)





LCIE

Accréditation  
N°5-0014  
Portée  
disponible sur  
www.cofrac.fr



# LICENCE



LCIE N° 621358

**Délivrée à:**  
*Delivered to:* **YUNG LI Co., Ltd**  
1F, No 10, Lane 235, Pao-Chiang Road, Hsin-Tien - TAIPEI - TAIWAN

**Site de fabrication:**  
*Factory:* **YUNG LI Co., Ltd. (1532AP)**  
Da Pu Industrial Zone, Gang Zi, Chang Ping Town - Dong Guan City - GUANG DONG PROVINCE 523571 - CHINE

**Produit:**  
*Product:* **Fiche de prise de courant**  
*Plug*

**Marque commerciale (s'il y a lieu):**  
*Trade mark (if any):* **YUNG-LI**

**Modèle, type, référence:**  
*Model, type, reference:* **YP-22**

**Caractéristiques nominales et principales:**  
*Rating and principal characteristics:* **16A 250V~, 2P avec contact de terre/2P with dual earthing contact voir annexe/see annex**

**Informations complémentaires:**  
*Additional informations:* **Mise à jour suite à évolution de la norme**  
*update further to the evolution of the standard*

**Le produit est conforme à:**  
*The product is in conformity with:* **NF C 61-314:2008 +A1:2010**

**Documents pris en compte:**  
*Relevant documents:* **Rapport d'essai/test report n° BVCB11DE1038ACSP, certificat d'essai OC/CB test certificate n° DE1-42031 / TR 1609800-1560-0002/122934**

**Annule et remplace (s'il y a lieu):**  
*Cancel and replaces (if necessary):* **Licence n°555296 du 2007-02-08**

En vertu de la présente décision notifiée par le LCIE France organisme mandaté, AFNOR Certification accorde le droit d'usage de la Marque NF à la société qui en est titulaire pour les produits visés ci-dessus, dans les conditions définies par les règles générales de la Marque NF et par les règles de certification NF, pour autant que les contrôles réguliers de la fabrication et les vérifications par tierce partie soient satisfaisants.

On the strength of the present decision notified by LCIE France mandated certification body, AFNOR Certification grants the right to use the NF Mark to the licence holder for the above mentioned products, within the frame of the general rules of the NF Mark and of the NF certification rules, as far as the regular checking and third party verifications of the production are satisfactory.

Fontenay-aux-Roses, 2012-01-11

**Michel BRENON**

**Date limite de validité :**

Directeur de la Certification  
Certification Manager

**Limit expired date :**

La validité de la présente licence cesse dès l'annulation de l'une des normes sur laquelle elle est fondée.  
*The present licence is valid until the cancellation of one of the standards on which it is based.*

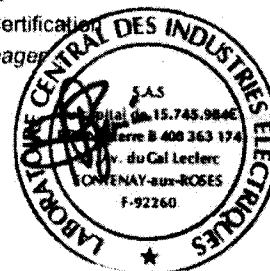

PID:  
02113100  
CID:  
C.1996.5269

## Certificato di approvazione

### Approval certificate

**IMQ, ente di certificazione accreditato, autorizza la ditta**      *IMQ, accredited certification body, grants to*

**YUNG LI CO., LTD.**  
**DA PU IND. ZONE, GangZi, CHANG PING TOWN**  
**DONG GUAN CITY, GUANG DONG PROV.**  
**CN - China**

**all'uso del marchio**

*the licence to use the mark*

**IMQ**

Il presente certificato è soggetto alle condizioni previste nel "Regolamento IMQ - Certificazione prodotto" ed è relativo ai prodotti descritti nell'Allegato al presente certificato.



**per i seguenti prodotti**

*for the following products*

**Spine indissolubilmente  
collegate al cavo  
( Rif. di tipo YP-22 )**

*Non-rewirable plugs  
( Type ref. YP-22 )*

*This certificate is subjected to the conditions foreseen by "IMQ Rules - Product Certification" and is relevant to the products listed in the annex to this certificate.*

Emesso il | Issued on      **2003-04-17**  
Aggiornato il | Updated on      **2011-09-21**  
Sostituisce | Replaces      **2008-06-17**

  
**IMQ S.p.A.**

**Allegato - Certificato di approvazione**  
**Annex - Approval certificate**

*Emesso il / Issued on* 2003-04-17  
*Aggiornato il / Updated on* 2011-09-21  
*Sostituisce / Replaces* 2008-06-17

**Prodotto | Product**

***Spine indissolubilmente collegate al cavo***  
***Non-rewirable plugs***

**Concessionario | Licence Holder**

**YUNG LI CO., LTD.**  
**DA PU IND. ZONE, GangZi, CHANG PING TOWN**  
**DONG GUAN CITY, GUANG DONG PROV.**  
**CN - China**

**Marchio | Mark**



IMQ

**Costruito a | Manufactured at**

PI.B000M3 C01175219

DONG GUAN CITY, GUANG DONG PROV.

China

*Copia del presente certificato deve essere conservata presso i luoghi di produzione sopra elencati.*

*Copy of this certificate must be available at the manufacturing places listed above*

**Norme**

CEI 23-50 - II Ed. 2007 + V1:2008

**Standards**

CEI 23-50 - II Ed. 2007 + V1:2008

**Rapporti | Test Reports**

26LL00072

**Caratteristiche tecniche | Technical characteristics**

*Designazione | Type designation* **2P+T+T S31 / 2P+E+E S31**  
*Tensione nominale | Rated voltage* **250 V**  
*Corrente nominale | Rated current* **16 A**  
*Grado di protezione | Degree of protection (IP)* **IP20**  
*Tipo di morsetti | Type of terminals* **morsetti aggraffati / crimped connections**  
*Materiale della custodia | Material of the cover* **termoplastico / thermoplastic**  
*Uscita cavo | Cable exit* **a squadra / angled**

**Articoli (con dettagli) | Articles (with details)**

AR.D0022W

*Marca | Trade mark* **YUNG-LI**  
*Riferimento di tipo | Type reference* **YP-22**  
*Tipo di cavo | Type of cable* **H03VV-F**  
*Sezione nominale | Section areas* **3G0,75 mm<sup>2</sup>**

AR.D0022X

*Marca | Trade mark* **YUNG-LI**  
*Riferimento di tipo | Type reference* **YP-22**  
*Tipo di cavo | Type of cable* **H05VV-F**  
*Sezione nominale | Section areas* **3G0,75 mm<sup>2</sup>**

AR.D0022Y

*Marca | Trade mark* **YUNG-LI**  
*Riferimento di tipo | Type reference* **YP-22**  
*Tipo di cavo | Type of cable* **H05VV-F**  
*Sezione nominale | Section areas* **3G1 mm<sup>2</sup>**

AR.D0022Z

Marca / Trade mark **YUNG-LI**  
Riferimento di tipo / Type reference **YP-22**  
Tipo di cavo / Type of cable **H05VV-F**  
Sezione nominale / Section areas **3G1,5 mm<sup>2</sup>**

## Ulteriori informazioni | Additional Information

La spina rif. di tipo YP-22 è prodotta col seguente inserto:  
marca: GEM ; art.: P98651.

The non-rewirable plug type ref. YP-23 is manufactured with the following insert:  
trade mark: GEM; art.: P98651.

## Componenti | Component List

### Rif. di tipo/Type ref. YP-22

Tipo / Type	(*)	Costruttore / Manufacturer	Riferimento / Type Ref.	Dati / Data	Norme / Standard (*)	Marchi / Marks
Cavo / Cable	2/4	YUNG LI	YUNG LI	H03VV-F	-	IMQ
Cavo / Cable	2/4	YUNG LI	YUNG LI	H05VV-F	-	IMQ

Emesso il / Issued on **2008-06-17**      Data di aggiornamento / Updated on **2011-09-21**      Sostituisce / Replaces **2008-06-17**

Ciascun componente è contraddistinto da un numero avente il seguente significato:

- 1 - Componente marchiato e sostituibile con altro pure marchiato con caratteristiche equivalenti
- 2 - Componente sostituibile solo previa autorizzazione dell'IMQ
- 3 - Componente (integrato nell'apparecchio utilizzatore) provato congiuntamente all'apparecchio utilizzatore
- 4 - Componente in alternativa
- 5 - Componente per uso opzionale
- 6 - Componente da abbinare

Each component is signed by a number having the following meaning:

- 1 - Approved component replaceable with another one also approved with equivalent characteristics
- 2 - Component replaceable with IMQ authorization only
- 3 - Integrated component tested together with appliances
- 4 - Alternative component
- 5 - Component for optional use
- 6 - Component to be matched

(\*) Queste colonne sono compilate a cura di IMQ / These columns are filled in by IMQ

## Diritti di concessione | Annual Fees

SN.D000DL      BTL.021100.DA19      Diritti modelli IMQ - 0211 - Prese, spine e connettori di uso domestico | IMQ models - 0211 - Plugs and appliance couplers for domestic purposes

1



**IMQ S.p.A.**

# DEMKO CERTIFICATE

**Certificate No.** D-05356  
**Page** 1/3  
**Date of Issue** 2016-07-18

**Certificate Holder** Yung-Li Co., Ltd.  
Da Pu Industrial Zone, Gangzi Chang Ping Town Dongguan, 523571  
GUANGDONG CHINA

**Manufacturer** Yung-Li Co., Ltd.  
Da Pu Industrial Zone, Gangzi Chang Ping Town Dongguan, 523571  
GUANGDONG CHINA

**Production site** Yung-Li Co., Ltd.  
Da Pu Industrial Zone, Gangzi Chang Ping Town Dongguan, 523571  
GUANGDONG  
CHINA

**Certified Product Model** Plug, non-rewirable  
YP-22  
See Page 2

**Trademark** YUNG LI

**Rated Voltage / Frequency** 250 V~

**Rated Current / Power** 16 A

**Insulation Class** -

**Degree of protection (IP)** 20

**Tested acc. to** DS 60884-2-D1:2011

**Test Report No.** NCS/FI 29581 issued on 2016-06-13

**Additional** This certificate replaces previous certificate D-01830.

**Expire date** 2021-06-13

---

**Certification Manager**  
Jan-Erik Storgaard

This is to certify that representative sample(s) of the Product described herein ("Certified Product") have been investigated and found in compliance with the Standard(s) indicated on this Certificate, in accordance with the D Mark Requirements. The Designated Certificate holder is entitled to use the d or for cables <DEMKO> for the Certified Product manufactured at the production site(s) identified above, in accordance with the D Mark Service Agreement, including without limitation the D Mark Testing and Certification Services Service Terms. Only those Products bearing the D Mark should be considered as being covered by UL's D Mark Service. This Certificate shall remain valid through the expiration date, unless terminated earlier in accordance with the Service Agreement including without limitation if the Standard identified on this Certificate is amended or withdrawn prior the expiration date.

**Certification Body**

UL International Demko A/S, Borupvang 5A, DK-2750  
Ballerup, Denmark, Tel. +45 44 85 65 65,  
info.dk@ul.com  
www.ul-europe.com



# Appendix DEMKO CERTIFICATE

**Certificate No.** D-05356  
**Page** 2/3  
**Date of Issue** 2016-07-18

**Model Details:**

YP-22 with cord:  
H03VV-F 3G0,75  
H03V2V2-F 3G0,75  
H05V2V2-F 3G0,75-1-1,5  
H05VV-F 3G0,75-1-1,5  
H05RN-F 3G0,75-1

**External Certification Information:**

This is based on certificate No. NCS/FI 29581 date on 2016-06-13 issued by SGS Fimko Ltd.

**Additional Information:**

Standard sheet CEE 7 / VII

---

**Certification Body**

UL International Demko A/S, Borupvang 5A, DK-2750  
Ballerup, Denmark, Tel. +45 44 85 65 65, info.dk@ul.com  
[www.ul-europe.com](http://www.ul-europe.com)





# Appendix DEMKO CERTIFICATE

Certificate No. D-05356  
Page 3/3  
Date of Issue 2016-07-18

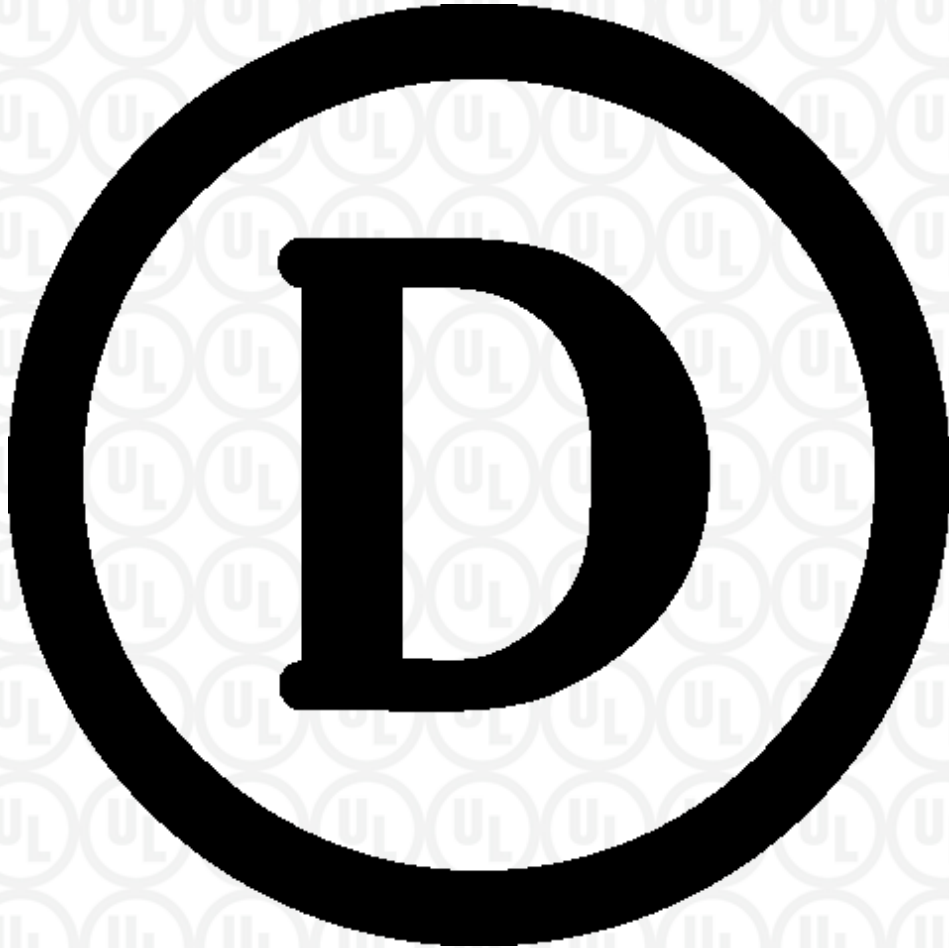

---

**Certification Body**

UL International Demko A/S, Borupvang 5A, DK-2750  
Ballerup, Denmark, Tel. +45 44 85 65 65, info.dk@ul.com  
[www.ul-europe.com](http://www.ul-europe.com)



Product	Plugs
Applicant	Yung Li Co., Ltd. China Da Pu Industrial Zone, Chang Ping Town, Dong Guan City, Guangdong Province 523571 China
Manufacturer	Yung Li Co., Ltd. China Da Pu Industrial Zone, Chang Ping Town, Dong Guan City, Guangdong Province 523571 China
Factory	Yung Li Co., Ltd. China Da Pu Industrial Zone, Chang Ping Town, Dong Guan City, Guangdong Province 523571 China
Ratings	16A 250V AC
Trade mark	YUNG LI
Model / Type Ref.	YP-22
Principal characteristics	Non-rewirable plug, Standard Sheet VII, with H03VV-F 3G0.75mm <sup>2</sup>
A sample of the product was tested and found to be in conformity with	INST IEC 60884-1:2002, IEC 60884-1:2002/AMD1:2006, IEC 60884-1:2002/AMD2:2013 NEK 502:2016
Validity	This certificate documents conformity with the standards shown, and also applies as license for use of Nemkos name and certification mark. The certificate and license is valid as long as the applicable conditions are complied with, and provided that any changes to the product are notified to Nemko for acceptance prior to implementation. New standards or amendments to the standards may imply that the product design must be updated and/or that re-testing and re-certification is necessary.
Additional information	
Additional model(s)	(4) See page 2

Date of issue 01-03-2017



Sweet Yuan

Certification Department

**Nemko AS**

Gaustadalléen 30, P.O. Box 73 Blindern, 0314 Oslo, Norway  
TEL +47 22 96 03 30 FAX +47 22 96 05 50 EMAIL info@nemko.com  
ENTERPRISE NUMBER NO974404532

Additional model(s)

Product	Plugs
Pos. No	1
Model / Type Ref.	YP-22
Trade mark (if different from page 1)	
Rating	16A 250V AC
Principal characteristics	Non-rewirable plug, Standard Sheet VII, with H05VV-F 3G0.75-1-1.5mm <sup>2</sup>
Product	Plugs
Pos. No	2
Model / Type Ref.	YP-22
Trade mark (if different from page 1)	
Rating	16A 250V AC
Principal characteristics	Non-rewirable plug, Standard Sheet VII, with H03V2V2-F 3G0.75mm <sup>2</sup>
Product	Plugs
Pos. No	3
Model / Type Ref.	YP-22
Trade mark (if different from page 1)	
Rating	16A 250V AC
Principal characteristics	Non-rewirable plug, Standard Sheet VII, with H05V2V2-F 3G0.7-1-1,5mm <sup>2</sup>
Product	Plugs
Pos. No	4
Model / Type Ref.	YP-22
Trade mark (if different from page 1)	
Rating	16A 250V AC
Principal characteristics	Non-rewirable plug, Standard Sheet VII, with H05RN 3G0.75-1mm <sup>2</sup>

Date of issue 01-03-2017



Sweet Yuan

Certification Department

**Nemko AS**

Gaustadalléen 30, P.O. Box 73 Blindern, 0314 Oslo, Norway  
TEL +47 22 96 03 30 FAX +47 22 96 05 50 EMAIL info@nemko.com  
ENTERPRISE NUMBER NO974404532

# Certificate



Intertek

for European Product Safety

Reference No. 1600036

## Plug, non rewirable

Type designation	YP-22
Certificate holder	<b>YUNG LI CO. LTD. DA PU INDUSTRIAL ZONE GANGZI CHANG PING TOWN DONGGUAN, 523571 GUANGDONG CHINA</b>
The product complies with the standard(s)	IEC 60884-1:2002 + A1 + A2 SS 428 08 34:2013
Date of expiry	12 February 2021

Additional information in Appendix.

Certification Body Intertek Semko AB, Product Certification Place Kista - Stockholm

Signed

  
Bo Berglöf

Date 12 February 2016  
Page 1 of 2

This certificate is issued in accordance with the terms and conditions set out in the Appendix.



**Intertek  
Appendix**

Reference No. 1600036

*Technical data*

Type designation	YP-22
Rated voltage (V)	250~
Rated current (A)	16
IP-Class	20
Type of cord	H03VV-F 3G0,75mm <sup>2</sup> H05VV-F 3G0,75-1,5mm <sup>2</sup> H05RN-F 3G0,75-1,0mm <sup>2</sup> H05V2V2-F 3G0,75-1,5mm <sup>2</sup> H03V2V2-F 3G0,75mm <sup>2</sup>
Standard sheet	CEE 7/VII
Trade mark	YUNG LI
Product information	Non rewirable plug for class I equipments. With angled cord entry.

This certificate replaces previously issued ref. No. 1312344 dated 2013-10-29 for YUNG LI CO. LTD. A new certificate has been issued on account of updating the standard.

The certificate applies for countries that have sanctioned the use of plugs/outlets according to subject standard sheet and component standard.

*Manufacturing site(s)* YUNG LI CO. LTD.  
DA PU INDUSTRIAL ZONE  
GANGZI CHANG PING TOWN  
DONGGUAN, 523571 GUANGDONG  
CHINA

*Certification Body* Intertek Semko AB, Product Certification *Place* Kista - Stockholm

*Signed*   
Bo Berglöf *Date* 12 February 2016

*This Certificate is for the exclusive use of Intertek's Client and is provided pursuant to the Certification agreement between Intertek and its Client. Intertek's responsibility and liability are limited to the terms and conditions of the agreement. Intertek assumes no liability to any party, other than to the Client in accordance with the agreement, for any loss, expense or damage occasioned by the use of this certificate. Only the Client is authorized to permit copying or distribution of this certificate and then only in its entirety. Use of Intertek's Certification mark is restricted to the conditions laid out in the agreement. Any further use of the Intertek name for the sale or advertisement of the tested material, product or service must first be approved in writing by Intertek. Initial Factory Assessments and Follow up Services are for the purpose of assuring appropriate usage of the Certification mark in accordance with the agreement, they are not for the purposes of production quality control and do not relieve the Client of their obligations in this respect.*

# CERTIFICATE

Issued to:  
Applicant:  
**Yung Li Co., Ltd.**  
**Da Pu Industrial Zone, Chang Ping Town**  
**523571 Dongguan City, China**

Manufacturer/Licensee:  
**Yung Li Co., Ltd.**  
**Da Pu Industrial Zone, Chang Ping Town**  
**523571 Dongguan City, China**

Product : plug, (2-pole)  
Trade name : YUNG LI  
Type/model : YP-22

The product and any acceptable variation thereto is specified in the Annex to this certificate and the documents therein referred to.

DEKRA hereby declares that the above-mentioned product has been certified on the basis of:

- a type test according to the standard IEC 60884-1:2002 + A1:2006 and NEN 1020:1987 + A2:2004
- an inspection of the production location according to CENELEC Operational Document CIG 021
- a certification agreement with the number 2078870

DEKRA hereby grants the right to use the KEMA-KEUR certification mark.

The KEMA-KEUR certification mark may be applied to the product as specified in this certificate for the duration of the KEMA-KEUR certification agreement and under the conditions of the KEMA-KEUR certification agreement.

This certificate is issued on 16 November 2012 and expires upon withdrawal of one of the above mentioned standards.

Certificate number: 2158219.01

DEKRA Certification B.V.



drs. G.J. Zoetbrood  
Managing Director



H.R.M. Barends  
Certification Manager

© Integral publication of this certificate is allowed

All testing, inspection, auditing and certification activities of the former KEMA Quality are an integral part of the DEKRA Certification Group.

ACCREDITED BY  
THE DUTCH COUNCIL  
FOR ACCREDITATION



**SPECIFICATION OF THE CERTIFIED PRODUCT**
**Product data**

product	: plug, (2-pole)
trade name	: YUNG LI
type	: YP-22, YP-22
rated current	: 16 A
rated voltage	: 250 V~
earthing	: with dual earthing contacts
design	: non-rewirable, angled
standard sheet	: VII
description	: body of thermoplastic material as part of a complete or incomplete cord set for class I appliances
markings	: are shown on the body

**List of components**

Component	trade name	type/model	approval mark <sup>1)</sup>
insert	GEM Terminal Ind. Co., Ltd.	98651A-VDE	*

<sup>1)</sup> \* indicates a component tested as part of the appliance

**Product data - type YP-22**

applied flexible cords	: H05RR-F 3G1,5 mm <sup>2</sup> H07RN-F 3G1,0 and 3G1,5 mm <sup>2</sup>
certification mark	: complies with the specified requirements
cord termination	: crimped connection
design	: big cord guard

**Product data - type YP-22**

applied flexible cords	: H03VV-F 3G0,75 mm <sup>2</sup> H03V2V2-F 3G0,75 mm <sup>2</sup> H05VV-F 3G0,75, 3G1,0 and 3G1,5 mm <sup>2</sup> H05V2V2-F 3G0,75, 3G1,0 and 3G1,5 mm <sup>2</sup> H05RR-F 3G0,75 and 3G1,0 mm <sup>2</sup> H05RN-F 3G0,75 and 3G1,0 mm <sup>2</sup>
certification mark	: complies with the specified requirements
cord termination	: crimped connection
design	: small cord guard

**TESTS**
**Test requirements**

IEC 60884-1:2002 + A1:2006  
NEN 1020:1987 + A2:2004

**Test result**

The test results are laid down in DEKRA test file 2158219.01.

**Remarks**

This certificate replaces our certificate 2026550.01 dated 2003-01-20 and is partly based on VDE CB Test Certificate DE1-42031 dated 2009-10-12.

**Conclusion**

The examination proved that all test requirements were met.

Tested by : VDE

Checked by : M.A.R. Bollen

**Factory locations**

Yung Li Co., Ltd.

Da Pu Industrial Zone, Chang Ping Town  
523571 Dongguan City, China



# LICENCE

No. 18291 replaces No.12989

Issued to:

Applicant:

**Yung Li Co. Ltd.**

**1F, No.10, Lane 235,**

**Pao-Chiao Road**

**Hsin-Tien, New Taipei, Taiwan**

Licensee:

**Yung Li Co. Ltd.**

**1F, No.10, Lane 235,**

**Pao-Chiao Road**

**Hsin-Tien, New Taipei, Taiwan**



Product : plugs (2-pole) for household purposes

Trade name(s) : YUNG-LI

Type(s)/model(s) : YP-22

The product and any acceptable variation thereto is specified in the annex to this licence and the documents therein referred to.

SGS CEBEC hereby declares that the above-mentioned product has been certified on the basis of:

- a type test according to the standard specified in annex
- an inspection of the production location
- a certification agreement with the number 1031

SGS CEBEC hereby grants the right to use the CEBEC certification mark

The CEBEC certification mark may be applied to the product as specified in this licence for the duration of the CEBEC certification agreement and under the conditions of the CEBEC certification agreement.

This licence is issued on: 26/03/2013

ir. C. Lana,  
Certification Manager

© Only integral publication of this certificate, including the annex, is allowed

This certificate is only valid combined with the publication on the following web address: [www.sgs.com/ee](http://www.sgs.com/ee)

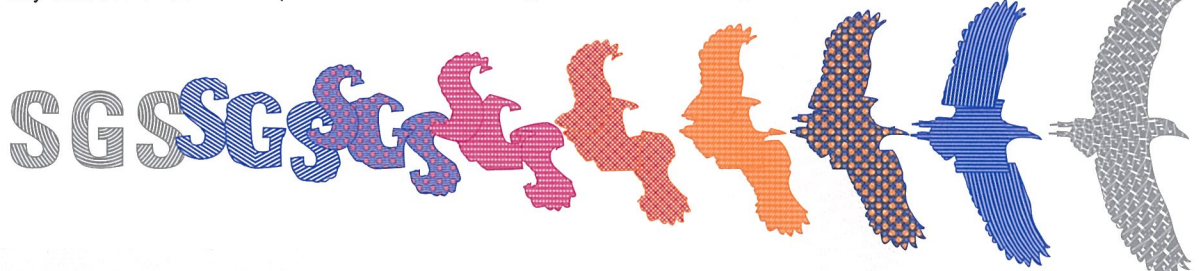

## SPECIFICATION OF THE CERTIFIED PRODUCT

### Product data

Product	:	plugs (2-pole) for household purposes
Trade name(s)	:	YUNG-LI
Type(s)/Model(s)	:	YP-22
rated current (In)	:	16 A
rated voltage (Un)	:	250 Vac
earthing	:	with dual earthing system
design	:	non-rewirable angled cable entry
class	:	for class I appliances
standard sheet	:	VII of CEE 7
applied flexible cord(s)	:	H03 VV-F 3G0.75 mm <sup>2</sup> H05 VV-F 3G0.75-1.5 mm <sup>2</sup> H03V2V2-F 3 G 0,75 mm <sup>2</sup> H05V2V2-F 3 G 0,75-1.5 mm <sup>2</sup>
description	:	body of thermoplastic material as part of an incomplete cord set for class I appliances
applied flexible cord(s) (cont'd)	:	H05RR-F 3 G 0,75-1,5 mm <sup>2</sup> H05RN-F 3 G 0,75-1.0 mm <sup>2</sup> H07RN-F 3 G 1,0-1,5 mm <sup>2</sup>
cord(s) termination	:	crimped connection
certification mark	:	complies with the requirements
markings	:	are shown on the body

### Additional information

Live part carriers: PBT, type 4115, black, Chang Chun Plastics.  
Moulding: PVC, type Flex 60 O, all colours, Pure Friend Business Enterprise Corp.  
Insert: GEM

## TESTS

### Test requirements

NBN C 61-112-1 based on IEC 60884-1:2002 + A1:2006

**Test results**

The test results are laid down in certification file ref.596812/01

**Remarks**

This certificate is based on certificate ref. CB DE1-42031 and test report(s) ref. 1609800-1560-0002/122934

**Conclusion**

The examination proved that all test requirements were met.

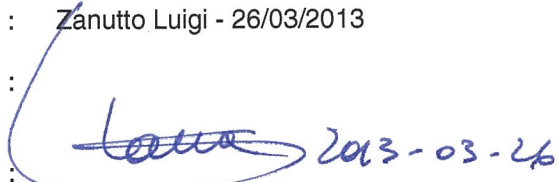
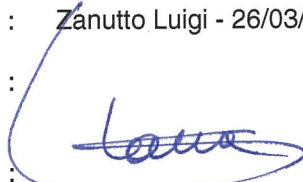
Checked by, project leader : Zanutto Luigi - 26/03/2013  
Department Manager, :  
Product Certification :   
Certification Manager :  2013-03-26

**FACTORY LOCATION(S)**

Yung Li Co., Ltd.  
Da Pu Industrial Zone, GanZi  
Chang Ping Town, Dong Guan City  
523571 Guang Dong Province  
China



# CERTIFICATE NCS/FI 29581

Our Ref. 284214-1

**Product** Plug, non-rewirable

**Type** YP-22, with cord H03VV-F 3G0,75  
 YP-22, with cord H03V2V2-F 3G0,75  
 YP-22, with cord H05V2V2-F 3G0,75-1-1,5  
 YP-22, with cord H05VV-F 3G0,75-1-1,5  
 YP-22, with cord H05RN-F 3G0,75-1

**Trade mark** YUNG LI

**Certificate Holder/  
 Manufacturer** Yung-Li Co., Ltd.  
 Da Pu Industrial Zone, Gangzi Chang Ping Town  
 Dongguan, 523571 GUANGDONG  
 CHINA

**Technical information** 16 A, 250 V~, IP20

**Other information** Standard sheet CEE 7 / VII

**The product is certified according to the following standard(s)** IEC 60884-1:2002 (Ed 3) + A1:2006 + A2:2013  
 SFS 5610:2015

**Validity** This certificate is valid until 13 June 2021 unless the standard in question has been amended or superseded with significant changes in requirements, in which case, SGS Fimko has the right to shorten the validity of the certificate based on the legislation of the European Union. This certificate includes the right to use the FI mark under the condition that changes (if any) will be checked at SGS Fimko before the product is brought onto market and that the conditions for FI certification are met.

**Date of issue** 13 June 2016

**Signature** **SGS Fimko Ltd**

Sixten Lökfors  
 Project Manager



This certificate has 1 appendix



This certificate is issued by the company under its General Conditions for Certification Services accessible at <http://www.sgs.fi/en/Terms-and-Conditions.aspx>. Attention is drawn to the limitations of liability defined therein and in the Test Report here above mentioned which findings are reflected in this certificate. Any unauthorized alteration, forgery or falsification of the content or appearance of this document is unlawful and offenders may be prosecuted to the fullest extent of the law.



## СЕРТИФИКАТ СООТВЕТСТВИЯ

№ ТС ВУ/112 02.01. 020 03966

Серия ВУ № 0038758

## ОРГАН ПО СЕРТИФИКАЦИИ

Открытое акционерное общество «Испытания и сертификация бытовой и промышленной продукции «БЕЛЛИС»;  
 юридический адрес: Республика Беларусь, 220029, г. Минск, ул. Красная, 7Б;  
 фактический адрес: Республика Беларусь, 220029, г. Минск, ул. Красная, 8; телефон: +375 17 288 16 41;  
 факс: +375 17 288 16 41; e-mail: bellis@bellis.by; аттестат аккредитации № ВУ/112.020.02 от 22.03.2011,  
 Республиканское унитарное предприятие «Белорусский государственный центр аккредитации».

## ЗАЯВИТЕЛЬ

YUNG LI CO., LTD.,  
 юридический адрес: Da Pu Industrial Zone, Chang Ping Town, Dong Guan City, Guangdong, 523571, Китай;  
 фактический адрес: Da Pu Industrial Zone, Chang Ping Town, Dong Guan City, Guangdong, 523571, Китай;  
 телефон: + 8676983335989; факс: + 8676983396796; e-mail: eng@yung-li.com

## ИЗГОТОВИТЕЛЬ

YUNG LI CO., LTD., Da Pu Industrial Zone, Chang Ping Town, Dong Guan City, Guangdong, 523571, Китай

## ПРОДУКЦИЯ

Вилка (plug, non rewirable) YUNG-LI модель YP-23

серийный выпуск

8544 42 290 0

## КОД ТН ВЭД ТС

## СООТВЕТСТВУЕТ ТРЕБОВАНИЯМ

Технический регламент Таможенного союза «О безопасности низковольтного оборудования»  
 ТР ТС 004/2011; ГОСТ Р 51322.1-2011

## СЕРТИФИКАТ ВЫДАН НА ОСНОВАНИИ

протокола аккредитованной испытательной лаборатории «БЕЛЛИС», ВУ/112 02.1.0.0001,  
 №№ 101-14-2650 от 22.12.2014;  
 отчета о проверке производства от 05.11.2014.

## ДОПОЛНИТЕЛЬНАЯ ИНФОРМАЦИЯ

СРОК ДЕЙСТВИЯ С 23.12.2014 ПО 22.12.2019



Руководитель (уполномоченное  
 лицо) органа по сертификации

Эксперт-аудитор (эксперт)

*(Signature)*  
 подпись

*(Signature)*  
 подпись

А.Г. Раковский

инициалы, фамилия

А.В. Сиводед

инициалы, фамилия

## ZEICHENGENEHMIGUNG MARKS APPROVAL

Yung-Li Co. Ltd.  
Da Pu Industrial Zone, Cang Zi  
Chang Ping Town  
523571 DONG GUAN CITY  
Guangdong  
CHINA

ist berechtigt, für ihr Produkt /  
is authorized to use for their product

**Gerätesteckdose, nicht-wiederanschließbar**  
**Connector, non-rewirable**

die hier abgebildeten markenrechtlich geschützten Zeichen  
für die ab Blatt 2 aufgeführten Typen zu benutzen /  
the legally protected Marks as shown below for the types referred to on page 2 ff.



Geprüft und zertifiziert nach /  
Tested and certified according to

DIN EN 60320-1 (VDE 0625-1):2008-05; EN 60320-1:2001 + A1:2007

VDE Prüf- und Zertifizierungsinstitut GmbH  
VDE Testing and Certification Institute  
Zertifizierungsstelle / Certification

VDE Zertifikate sind nur gültig bei Veröffentlichung unter:  
VDE certificates are valid only when published on:

# VDE

Aktenzeichen: 1609800-1550-0003 / 148086

File ref.:

Ausweis-Nr. 40029577

Blatt 1

Certificate No.

Page

Weitere Bedingungen siehe Rückseite und Folgebätter /  
further conditions see overleaf and following pages

Offenbach, 2010-03-05

(letzte Änderung/updated 2011-08-16 )

<http://www.vde.com/zertifikat>

<http://www.vde.com/certificate>



Name und Sitz des Genehmigungs-Inhabers / *Name and registered seat of the Certificate holder*

Yung-Li Co. Ltd., Da Pu Industrial Zone, Gang Zi, Chang Ping Town, 523571 DONG GUAN CITY,  
Guangdong, CHINA

Aktenzeichen / *File ref.*

1609800-1550-0003 / 148086 / FG31 / E

letzte Änderung / *updated* Datum / *Date*

2011-08-16 2010-03-05

Dieses Blatt gilt nur in Verbindung mit Blatt 1 des Zeichengenehmigungsausweises Nr. 40029577  
*This supplement is only valid in conjunction with page 1 of the Certificate No. 40029577.*

**Gerätesteckdose, nicht-wiederanschließbar**  
**Connector, non-rewirable**

Typ(en) / *Type(s)*:

- 1) YC-12
- 2) YC-12L

Bemessungsspannung  
*Rated voltage*

AC 250 V

Bemessungsstrom  
*Rated current*

10 A

Polzahl  
*Number of poles*

2-polig mit Schutzkontakt  
*2-pole with earthing contact*

Bauart  
*Kind of construction*

Normblatt C13  
*standard sheet C13*

Warenzeicheninhaber  
*Trademark holder*

Yung Li Co. Ltd.

Produktinformation  
*Product information*

siehe Anlage Nr. 300 + 400 + 900  
*see Appendix No. 300 + 400 + 900*

PAK

Das Produkt entspricht den Anforderungen gemäß PAK-Dokument  
ZEK 01.2-08.

PAH

*The product is in accordance with the requirements of  
PAH-document ZEK 01.2-08.*

Fortsetzung siehe Blatt 3 /  
*continued on page 3*



# VDE Prüf- und Zertifizierungsinstitut

Aktenzeichen:  
File reference: **1609800-1550-0003/148086**

Ausweis-Nr.:  
Certificate No.: **40029577**

Anlage Nr.: **300**  
Appendix No.:

Seite: **1 / 1**

Datum: **2011-08-16**  
Date:

Diese Anlage ist Bestandteil des Genehmigungsausweises. This appendix is part of the certificate.

**Gerätesteckdose, nicht-wiederausziehbar  
Connector, non-rewirable**

**2-polig mit Schutzkontakt  
2-pole with earthing contact**

**zentrale Leitungseinführung  
straight cable entry**

**Fertigungsstätte / Place of manufacture:**

**30008928** : Kennzeichnung / Identification : **Keine / without**

Werkstoff der Umspritzung: Typ: Farbe  
Material of the moulding: Type: colour  
Werkstoff der Trägereile: Typ: Hersteller, Farbe  
Material of the base: Type: manufacturer, colour  
Inneneinsatz: Typ: Hersteller  
Insert: Type: manufacturer

PVC, Typ(e) CS-9731-WB; alle Farben / all colours  
CHIA SHIN ENTERPRISES Co. Ltd.

Type without front cover:



Type with front cover:



**X** **Δ** genehmigte Ausführung / approved version      **---** **Δ** nicht genehmigt / not approved

Position im VDE-Ausweis Position in VDE-licence																		
YC-12 Typ(en) Type(s)	Leitungsaufdruck Marking on cable	YUNG LI	WONDERFUL	Yong Tai														
YC-12					X	--	X	--	X	--	X	--	X	--	X	--	X	--
	H05VV-F 3G 0,75 mm <sup>2</sup> (max. 2 m)																	
	H05VV-F 3G 1,0 mm <sup>2</sup>																	
	H05VV-F 3G 1,5 mm <sup>2</sup>																	
	H05RR-F 3G 0,75 mm <sup>2</sup> (max. 2 m)				X	--	X	--	X	--	X	--	X	--	X	--	X	--
	H05RR-F 3G 1,0 mm <sup>2</sup>																	
	H05RR-F 3G 1,5 mm <sup>2</sup>																	
	H05RN-F 3G 0,75 mm <sup>2</sup> (max. 2 m)				X	--	X	--	X	--	X	--	X	--	X	--	X	--
	H05RN-F 3G 1,0 mm <sup>2</sup>																	
	H03RT-H 3G 0,75 mm <sup>2</sup> (max. 2 m)																	
	H03RT-H 3G 1,0 mm <sup>2</sup>																	
	H05V2V2-F 3G 0,75 mm <sup>2</sup> (max. 2 m)																	
	H05V2V2-F 3G 1,0 mm <sup>2</sup>																	
	H05V2V2-F 3G 1,5 mm <sup>2</sup>																	



VDE Prüf- und Zertifizierungsinstitut GmbH Fachbereich F3  
VDE Testing and Certification Institute Department F3



# VDE Prüf- und Zertifizierungsinstitut

Aktenzeichen: **1609800-1550-0003/148086**  
File reference:

Ausweis-Nr.: **40029577**  
Certificate No.:

Anlage Nr.: **400**  
Appendix No.:

Seite: **1 / 1**  
Page:

Datum: **2011-08-16**  
Date:

Diese Anlage ist Bestandteil des Genehmigungsausweises. *This appendix is part of the certificate.*

**Gerätesteckdose, nicht-wiederanschließbar**  
**Connector, non-rewirable**

**2-polig mit Schutzkontakt**  
**2-pole with earthing contact**

**abgewinkelt Leitungseinführung**  
**angled cable entry**

**Fertigungsstätte / Place of manufacture:**

**30008928** : Kennzeichnung / Identification : **Keine / without**

Werkstoff der Umspritzung: Typ: Farbe  
*Material of the moulding: Type; colour*

PVC, Typ(e) CS-9731-WB; alle Farben / *all colours*  
CHIA SHIN ENTERPRISES Co. Ltd.

Type without cover of insert:

Type with cover of insert:

Werkstoff der Trägereile: Typ; Hersteller; Farbe  
*Material of the base: Type; manufacturer; colour*

Insert:  
PBT, Typ(e) 4115(a); weiß / *white*  
Chang Chun Plastics Co., Ltd.

Front cover:  
PBT, Typ(e) 4115(a); black / *schwarz*  
Chang Chun Plastics Co., Ltd.

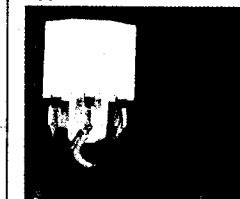

Inneneinsatz: Typ; Hersteller  
*Insert: Type; manufacturer*

---

Position im VDE-Ausweis Position in VDE-licence	Typ(en) Type(s)	Leitungsaufdruck Marking on cable	X $\Delta$ genehmigte Ausführung / <i>approved version</i>													--- $\Delta$ nicht genehmigt / <i>not approved</i>					
			H05VV-F 3G 0,75 mm <sup>2</sup> (max. 2 m)	H05VV-F 3G 1,0 mm <sup>2</sup>	H05VV-F 3G 1,5 mm <sup>2</sup>	H05RR-F 3G 0,75 mm <sup>2</sup> (max. 2 m)	H05RR-F 3G 1,0 mm <sup>2</sup>	H05RR-F 3G 1,5 mm <sup>2</sup>	H05RN-F 3G 0,75 mm <sup>2</sup> (max. 2 m)	H05RN-F 3G 1,0 mm <sup>2</sup>	H03RT-H 3G 0,75 mm <sup>2</sup> (max. 2 m)	H03RT-H 3G 1,0 mm <sup>2</sup>	H05V2V2-F 3G 0,75 mm <sup>2</sup> (max. 2 m)	H05V2V2-F 3G 1,0 mm <sup>2</sup>	H05V2V2-F 3G 1,5 mm <sup>2</sup>						
2)	YC-12L	YUNG LI	X	X	X	--	--	--	--	--	--	X	X	X	--	--	--	--	--	--	
2)	YC-12L	I-SHENG	X	X	X	--	--	--	--	--	--	--	--	--	--	--	--	--	--	--	--
2)	YC-12L	WONDERFUL Yong Tai	--	--	--	X	X	X	X	X	--	--	--	--	--	--	--	--	--	--	--

Certificate Number: 22012

# CERTIFICATE OF APPROVAL

ISSUED PURSUANT TO THE ELECTRICITY (CONSUMER SAFETY) ACT 2004

**ISSUED TO:**

Yung Li Co Ltd

**CLASS OF ARTICLE:**

Appliance Connector

**DESCRIPTION OF ARTICLE:**

Appliance Connector  
(Non-rewirable, straight entry, Group 1, C13 appliance connector for cold conditions for Class I equipment integrally moulded to any <HAR> certified H05VV-F 3G1.00mm<sup>2</sup> or Australian approved three-core, 1.00mm<sup>2</sup>, PVC insulated and sheathed ordinary duty circular flexible cord)  
250V, ac, 10A

**EXAMINED FOR COMPLIANCE WITH:** AS/NZS 60320.1 : 2004

**TYPE REFERENCE CODE:** Type No. YC-12

**APPROVAL MARK:**

Each electrical article of the abovementioned type shall be marked with Approval Number NSW22012 or N14877 ;or  
the Regulatory Compliance Mark (RCM) provided that the requirements of all relevant parts of AS/NZS 4417 applicable to the article are fulfilled.

**DATE OF APPROVAL:** 31 October 2006

This approval expires 31 October 2011 unless suspended, cancelled, renewed or extended.



for Commissioner for Fair Trading

Ref: 22012/1

**ADDENDUM TO CERTIFICATE OF APPROVAL 22012****Particulars of Modification(s)**

1. Type No. YC-12 alternatively moulded to any <HAR> certified H05VV-F 3G0.75mm<sup>2</sup> or Australian approved, three-core, 0.75mm<sup>2</sup>, PVC insulated and sheathed ordinary duty circular flexible cord not exceeding two metres in length.
  
2. Type No. YP-32 being similar to original Type No. YC-12 except a Standard Sheet 'E' Interconnection Plug Connector (AS/NZS 60320.2.2) alternatively moulded to either:-
  - (a) Any <HAR> certified H05VV-F 3G1.00mm<sup>2</sup> or equivalent Australian approved flexible cord; or
  - (b) Any <HAR> certified H05VV-F 3G0.75mm<sup>2</sup> or equivalent Australian approved flexible cord not exceeding two metres in length.
  
3. Type No. YC-12 alternatively moulded to any <HAR> certified H05VV-F 3G1.5mm<sup>2</sup> or Australian approved three-core, 1.5mm<sup>2</sup>, PVC insulated and sheathed ordinary duty circular flexible cord.

Approved: 31 October 2006



for Commissioner for Fair Trading



Fair  
Trading

Ref: NSW22012/2

## RENEWAL OF CERTIFICATE OF APPROVAL NSW22012

### PARTICULARS OF RENEWAL

The approval of the original appliance connector Model YC-12 and approved modifications has been renewed.

The Approval expires on 31/10/2016 unless it is renewed, extended, suspended or cancelled.

A handwritten signature in black ink, appearing to be "D. J. ...".

For Commissioner for Fair Trading



Fair  
Trading

Ref: NSW22012/3

## RENEWAL OF CERTIFICATE OF APPROVAL: NSW22012

### Particulars of Renewal

The approval of the original appliance connector Model YC-12 and approved modifications has been renewed for FIVE years.

The Approval expires on 31/10/2021 unless it is renewed, extended, suspended or cancelled.

For Commissioner for Fair Trading

## ZEICHENGENEHMIGUNG MARKS APPROVAL

Yung-Li Co. Ltd.  
Da Pu Industrial Zone, Cang Zi  
Chang Ping Town  
523571 DONG GUAN CITY  
Guangdong  
CHINA

ist berechtigt, für ihr Produkt /  
*is authorized to use for their product*

**Starkstromleitungen für allgemeine Anwendungen**  
**- Flexible Leitungen**  
**mit thermoplastischer PVC-Isolierung**  
***Cables for general applications***  
**- *Flexible cables with***  
***thermoplastic PVC insulation***

die hier abgebildeten markenrechtlich geschützten Zeichen  
für die ab Blatt 2 aufgeführten Typen zu benutzen /  
*the legally protected Marks as shown below for the types referred to on page 2 ff.*



oder/or



oder/or



schwarz  
black

rot  
red

Geprüft und zertifiziert nach /  
*Tested and certified according to*

DIN EN 50525-2-11 (VDE 0285-525-2-11):2012-01; EN 50525-2-11:2011



VDE Prüf- und Zertifizierungsinstitut GmbH  
*VDE Testing and Certification Institute*  
Zertifizierungsstelle / *Certification*

K. Prohaska

Aktenzeichen: 1609800-5140-0005 / 171941  
*File ref.:*

Ausweis-Nr. 40010145 Blatt 1  
*Certificate No. Page*

Weitere Bedingungen siehe Rückseite und Folgeblätter /  
*further conditions see overleaf and following pages*

Offenbach, 2004-04-27  
(letzte Änderung/updated 2012-09-25 )

VDE Zertifikate sind nur gültig bei Veröffentlichung unter:  
*VDE certificates are valid only when published on:*

<http://www.vde.com/zertifikat>  
<http://www.vde.com/certificate>

Name und Sitz des Genehmigungs-Inhabers / *Name and registered seat of the Certificate holder*  
Yung-Li Co. Ltd., Da Pu Industrial Zone, Cang Zi, Chang Ping Town, 523571 DONG GUAN CITY,  
Guangdong, CHINA

Aktenzeichen / *File ref.*  
1609800-5140-0005 / 171941 / FG42 / HEG

letzte Änderung / *updated* Datum / *Date*  
2012-09-25 2004-04-27

Dieses Blatt gilt nur in Verbindung mit Blatt 1 des Zeichengenehmigungsausweises Nr. 40010145  
*This supplement is only valid in conjunction with page 1 of the Certificate No. 40010145.*

**Starkstromleitungen für allgemeine Anwendungen**  
**- Flexible Leitungen**  
**mit thermoplastischer PVC-Isolierung**  
***Cables for general applications***  
**- Flexible cables with**  
***thermoplastic PVC insulation***

Typ(en) / *Type(s)*:

H03VV-F 2...4 x 0,5...0,75 mm <sup>2</sup>	+
H03VVH2-F 2 x 0,5...0,75 mm <sup>2</sup>	+
H05VV-F 2...5 x 0,75...4 mm <sup>2</sup>	+
H05VVH2-F 2 x 0,75...1,0 mm <sup>2</sup>	+

Leitungsbauart <i>Type of cable</i>	Standardleitungen <i>General purpose cables</i>
--	--

Firmenzeichen <i>Trademark</i>	YUNG LI
-----------------------------------	---------

Dieser Zeichengenehmigungs-Ausweis bildet eine Grundlage für die EG-Konformitätserklärung und CE-Kennzeichnung durch den Hersteller oder dessen Bevollmächtigten und bescheinigt die Konformität mit den grundlegenden Schutzanforderungen der **EG-Niederspannungsrichtlinie 2006/95/EG** mit ihren Änderungen.

*This Marks Approval is a basis for the EC Declaration of Conformity and the CE Marking by the manufacturer or his agent and proves the conformity with the essential safety requirements of the EC Low-Voltage Directive 2006/95/EC including amendments.*

VDE Prüf- und Zertifizierungsinstitut GmbH  
*VDE Testing and Certification Institute*  
Fachgebiet FG42  
*Section FG42*



Name und Sitz des Genehmigungs-Inhabers / *Name and registered seat of the Certificate holder*  
Yung-Li Co. Ltd., Da Pu Industrial Zone, Cang Zi, Chang Ping Town, 523571 DONG GUAN CITY,  
Guangdong, CHINA

Aktenzeichen / *File ref.*  
1609800-5140-0005 / 171941 / FG42 / HEG

letzte Änderung / *updated* Datum / *Date*  
2012-09-25 2004-04-27

Dieses Beiblatt ist Bestandteil des Zeichengenehmigungsausweises Nr. 40010145.  
*This supplement is part of the Certificate No. 40010145.*

**Starkstromleitungen für allgemeine Anwendungen**  
**- Flexible Leitungen**  
**mit thermoplastischer PVC-Isolierung**  
***Cables for general applications***  
**- Flexible cables with**  
***thermoplastic PVC insulation***

**Fertigungsstätte(n)**  
***Place(s) of manufacture***

Referenz/*Reference*      Yung-Li Co. Ltd.  
**30008928**                Da Pu Industrial Zone, Cang Zi  
                                 Chang Ping Town  
                                 523571 DONG GUAN CITY  
                                 Guangdong  
                                 CHINA

VDE Prüf- und Zertifizierungsinstitut GmbH  
*VDE Testing and Certification Institute*  
Fachgebiet FG42  
*Section FG42*

# VDE Prüf- und Zertifizierungsinstitut

## Zeichengenehmigung

Ausweis-Nr. / Infoblatt /  
Certificate No. Info sheet  
40010145

Name und Sitz des Genehmigungs-Inhabers / *Name and registered seat of the Certificate holder*

Yung-Li Co. Ltd., Da Pu Industrial Zone, Cang Zi, Chang Ping Town, 523571 DONG GUAN CITY,  
Guangdong, CHINA

Aktenzeichen / *File ref.*

1609800-5140-0005 / 171941 / FG42 / HEG

letzte Änderung / *updated* Datum / *Date*

2012-09-25 2004-04-27

Dieses Blatt gilt nur in Verbindung mit Blatt 1 des Zeichengenehmigungsausweises Nr. 40010145  
*This supplement is only valid in conjunction with page 1 of the Certificate No. 40010145.*

### **Genehmigung zum Benutzen des auf Seite 1 abgebildeten markenrechtlich geschützten Zeichens des VDE:**

Grundlage für die Benutzung sind die Allgemeinen Geschäftsbedingungen (AGB) der VDE Prüf- und Zertifizierungsinstitut GmbH ([www.vde.com](http://www.vde.com)\AGB-Institut). Das Recht zur Benutzung erstreckt sich nur auf die bezeichnete Firma mit den genannten Fertigungsstätten und die oben aufgeführten Produkte mit den zugeordneten Bezeichnungen. Die Fertigungsstätte muss so eingerichtet sein, dass eine gleichmäßige Herstellung der geprüften und zertifizierten Ausführung gewährleistet ist.

Die Genehmigung ist so lange gültig wie die VDE-Bestimmungen gelten, die der Zertifizierung zugrunde gelegen haben, sofern sie nicht auf Grund anderer Bedingungen aus der VDE Prüf- und Zertifizierungsordnung (PM102) zurückgezogen werden muss.

Der Gültigkeitszeitraum einer VDE-GS-Zeichengenehmigung kann auf Antrag verlängert werden. Bei gesetzlichen und / oder normativen Änderungen kann die VDE-GS-Zeichengenehmigung ihre Gültigkeit zu einem früheren als dem angegebenen Datum verlieren.

Produkte, die das Biozid Dimethylfumarat (DMF) enthalten, dürfen gemäß der Kommissionsentscheidung 2009/251/EG nicht mehr in den Verkehr gebracht oder auf dem Markt bereitgestellt werden.

Der VDE-Zeichengenehmigungsausweis wird ausschließlich auf der ersten Seite unterzeichnet.

### ***Approval to use the legally protected Mark of the VDE as shown on the first page:***

*Basis for the use are the general terms and conditions of the VDE Testing and Certification Institute ([www.vde.com](http://www.vde.com)\terms-institute). The right to use the mark is granted only to the mentioned company with the named places of manufacture and the listed products with the related type references. The place of manufacture shall be equipped in a way that a constant manufacturing of the certified construction is assured.*

*The approval is valid as long as the VDE specifications are in force, on which the certification is based on, unless it is withdrawn according to the VDE Testing and Certification Procedure (PM102E).*

*The validity period of a VDE-GS-Mark Approval may be prolonged on request. In case of changes in legal and / or normative requirements, the validity period of a VDE-GS-Mark Approval may be shortened.*

*Products containing the biocide dimethylfumarate (DMF) may not be marketed or made available on the EC market according to the Commission Decision 2009/251/EC.*

*The approval is solely signed on the first page.*