

東莞永力電業有限公司

YUNG LI CO., LTD

Da Pu Industrial Zone, Gang Zi, Changping Town,
Dong Guan City, Guangdong 523571 China.P.R.C

TEL:0769-83396797~8

FAX:0769-83396796

E-mail: sales@yung-li.com

Description: YP-CD/YC-1D

Customer: _SY

Parts No. : UI?`?fi`

Draw No. : Uk?fBEBG?BD

REVISION RECORD

1		
2		
3		
4		
5		

YUNG LI	
CHECKED	PREPARED BY

CUSTOMER	APPROVED

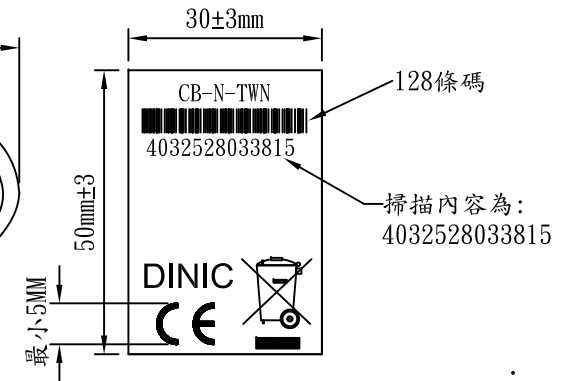
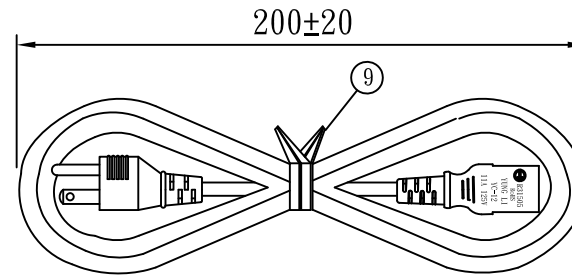
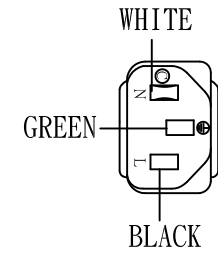
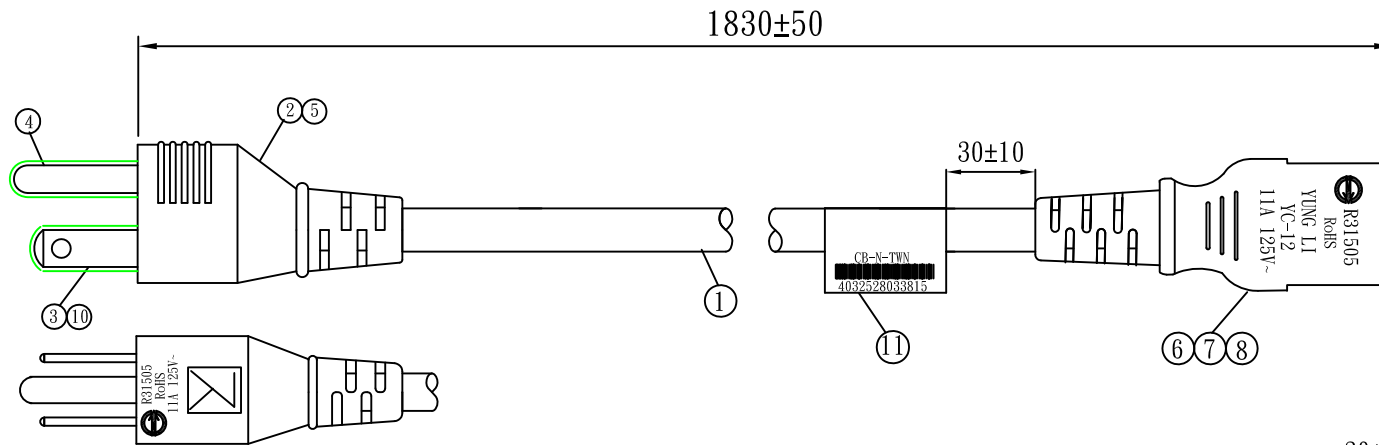
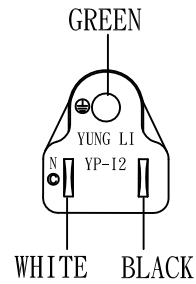



Sample Drawing No. :
SP200618-02

NO.	SPECIFICATION	QTY	REMARK
1	VCTF 1.25/3C BLACK (CNS)	1PC	1810±20(YL)
2	YP-12 PVC PLASTIC:50P BLACK	19g/PC	
3	TER:98675BS-1	2PCS	
4	TER:98475	1PC	
5	YP-12 INNER BODY	1PC	
6	"U" BRONZE TER:97740PS-0	3PCS	
7	YC-12 INNER BODY	1PC	
8	YC-12 PVC PLASTIC:50P BLACK	18g/PC	
9	MINI TIE BLACK	1PC	
10	SLEEVE	1PC	
11	Label:50x30mm 128Code	1PC	

Tolerance >0±0.30 >1.0±0.50 >10.0±1.0 >20.0±2.0 Angle: ±1°	Approved		Date	YUNG LI CO., LTD.				
	Checked		Date					
	Drawn	SUKI	Date	20.06.18	Customer	MAG		
	Cat. No.	YP-12/YC-12(CNS)			P/N.	CB-N-TWN		
	Drawing No.	CY-T0305-02		Rev.	B	Material	P.V.C	Unit
					Scale			

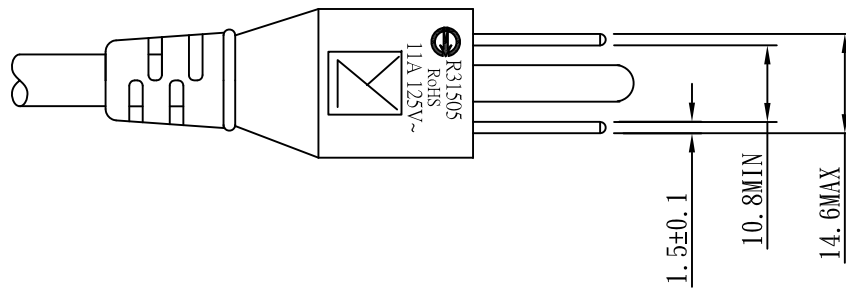
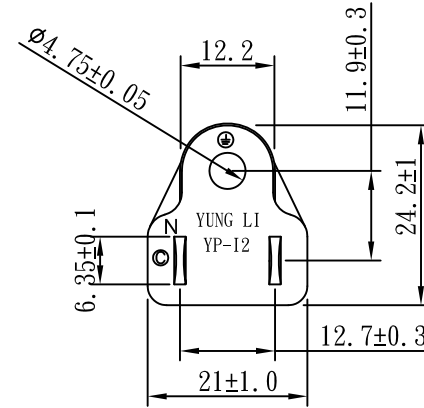
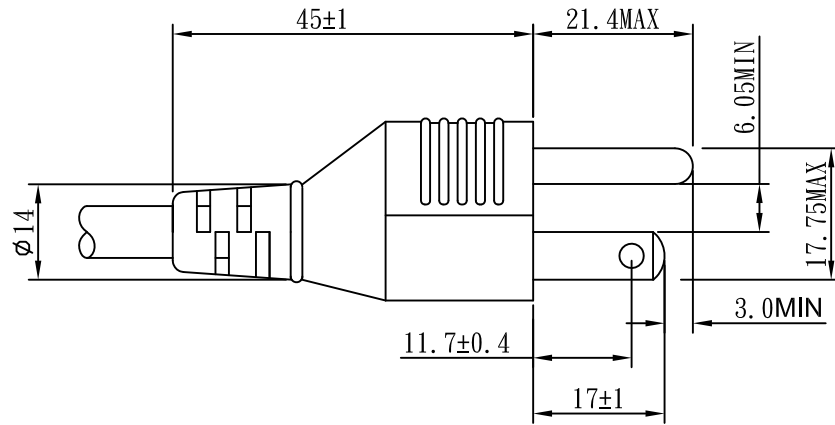

認証號:  R31505
RoHS

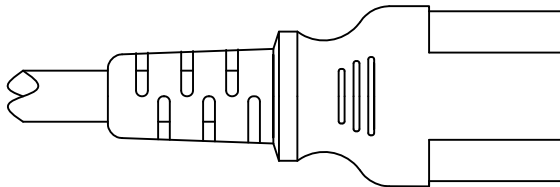
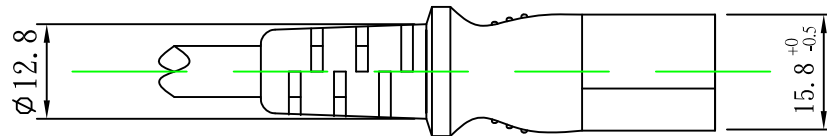
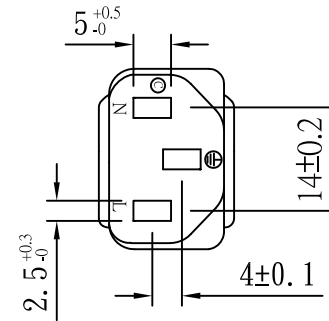
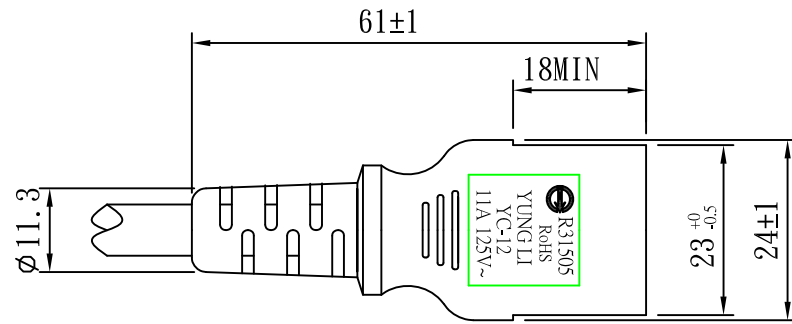

TOLERANCE >0±0.30 >1.0±0.50 >10.0±1.0 >20.0±2.0 Angle: ±1°	APPROVED		DATE		YUNG LI CO., LTD.			
	CHECKED		DATE					
	DRAWN		DATE					
	TYPE	YP-12(CNS)			P/N			
DRAWING NO	CY-P12CNS11A			MATERIAL	P. V. C	UNIT	mm	
				SCALE	1:1			

 R31505
RoHS



TOLERANCE >0±0.30 >1.0±0.50 >10.0±1.0 >20.0±2.0 Angle: ±1°	APPROVED		DATE		YUNG LI CO., LTD.			
	CHECKED		DATE					
	DRAWN		DATE					
	TYPE	YC-12(CNS)			P/N			
	DRAWING NO	CY-C12CNS11AB		MATERIAL	P. V. C	UNIT	mm	
				SCALE	1:1			

YUNG LI CO., LTD

SPECIFICATION

Yung-Li	Style	PVC FLEXIBLE CORDS	Document No
2005.09.22			
Edition	Size	CNS VCTF 3X1.25mm²	Page
A			1/2

1. Standard: CNS 3199
 2. Construction & Dimension

	Item	Specification
Conductor	Size	3 X 1.25mm ²
	Material	Annealed Bare Copper
	Construction	50/ ϕ 0.18mm \pm 0.008
Insulation	Material	PVC
	Minimum Average Thickness	0.54mm
	Minimum Thickness at any point	0.48mm
	Diameter	2.7 \pm 0.10mm
	Identification	Black, White, Green
Core Assembly	Core Twist	3-Core
	Filler	NA
	Assembly Pair	NA
Taping	Mylar Foil	NA
Shielded	A1-Mylar Foil	NA
Drain	Material	NA
	Construction	NA
Jacket	Material	PVC
	Minimum Average Thickness	0.9mm
	Minimum Thickness at any point	0.7mm
	Overall Diameter(Approx)	7.8 \pm 0.2mm
	Color	Any Color

Marking:

YUNG LI VCTF 3X1.25mm²  R31505 RoHS 20XX -F-

YUNG LI CO., LTD

SPECIFICATION

Yung-Li	Style	PVC FLEXIBLE CORDS	Document No
2005.09.22			
Edition	Size	CNS VCTF 3X 1.25mm²	Page
A			2/2

3. Electrical & Physical Properties

Item		Specification	
Rating Voltage		300V	
Conductor resistance(AT 20°C)		15.1Ω/Km MAX	
Insulation Resistance(AT 20°C)		5.0MΩ/Km Min	
Dielectric Strength		AC 1.0 KV / 1min No Break	
Spark Test		5KV/0.15sec	
Insulation	Unaged	Tensile Strength	1.02 kgf/mm ² min
		Elongation	100% Min
	Aged	Tensile Strength	Min 85% (100°C x48hrs)
		Elongation	Min 80% (100°C x48hrs)
Jacket	Unaged	Tensile Strength	1.02 kgf/mm ² min
		Elongation	100% Min
	Aged	Tensile Strength	Min 85% (100°C x48hrs)
		Elongation	Min 80% (100°C x48hrs)
Deformation Test		120±3°C m X 1hr ≤ 50%	
Cold Bend Test		-10°C ± x 1hr No Crack	
Heat Shock Test		120±3°C x 1hr No Crack	

Graph:

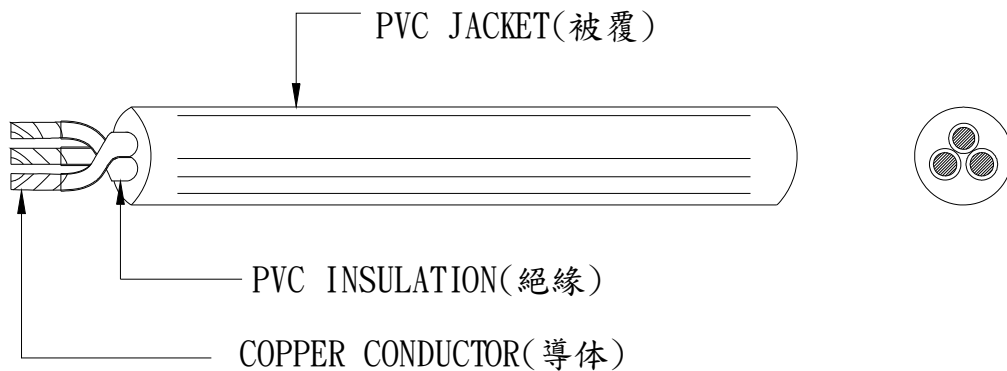



經濟部標準檢驗局

BUREAU OF STANDARDS, METROLOGY AND INSPECTION,
MINISTRY OF ECONOMIC AFFAIRS



商品驗證登錄證書

CERTIFICATE OF THE REGISTRATION OF PRODUCT CERTIFICATION

證書號碼： CI316065050451 號 01
Certificate No.

茲據 永力實業有限公司
定，准予登錄並使用商品安全標章  及識別號碼：
The application made by YUNG-LI Co., Ltd

申請驗證登錄，經審查結果符合規
R31505 其登錄事項如下：
for Registration of Product

Certification has been reviewed and found to be in compliance with related regulations. Therefore, registration is granted with the
Product Safety Mark  and the Identification No. R31505 . Details of the registration are follows :

申請人：永力實業有限公司
Applicant

統一編號：22792569
Uniform No.

地址：新北市汐止區新台五路一段99號7樓之12
Address

生產廠場：東莞永力電業有限公司
Factory

廠址：中國廣東省東莞市常平鎮崗梓大埔工業區
Factory Address

商品種類名稱：
Type/name of product

商品分類號列：8544.42.90.90.9-D
C.C.C Code

中文名稱：電源線組
Chinese name

英文名稱：
English name

型式：YP-17C+YC-18(125V 15A 2P+E C19)
Type

系列型式：詳如附表
Series of the type

依據標準：CNS15663第五節含有標示(102年版)、CNS60799(105年版)、IEC60320-1
Standards (2001)、CNS690(105年版)

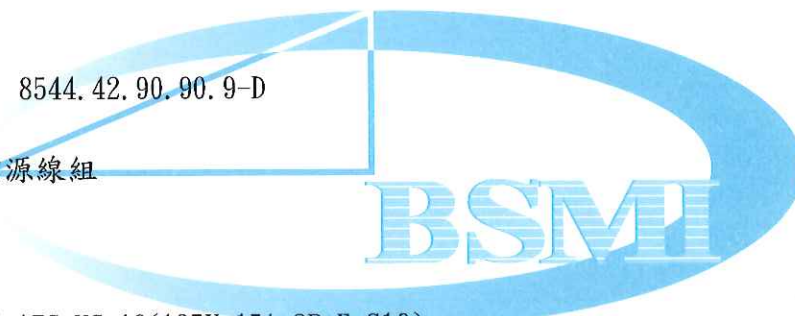

標準檢驗局發證(發證地址：100臺北市中正區濟南路1段4號)

This certificate is issued by the BSMI. (No.4, Sec. 1, Jinan Rd., Zhongzheng Dist., Taipei City 100, Taiwan)

登錄日期：中華民國	106	年	12	月	15	日
Registration Date	2017	(year)	12	(month)	15	(day)
本證書有效期限至	109	年	12	月	14	日
Expiration Date	2020	(year)	12	(month)	14	(day)
發證日期：中華民國	107	年	01	月	30	日
Date of issue	2018	(year)	01	(month)	30	(day)

註1：持本證書進口驗證登錄商品時，進口人須與本證書名義人相同。

註2：次年度商品驗證登錄年費繳納期限為當年11月30日，逾期未繳納者，經限期繳納屆期未繳納，即依商品檢驗法第42條第7款規定廢止驗證登錄，並自次年度1月1日起生效。

經濟部標準檢驗局
BUREAU OF STANDARDS, METROLOGY AND INSPECTION,
MINISTRY OF ECONOMIC AFFAIRS

商品驗證登錄證書
CERTIFICATE OF THE REGISTRATION OF PRODUCT CERTIFICATION

證書號碼： CI316065050451 號 01
Certificate No.

系列型式： YP-12+YC-12(11A C13)
Series of the type

YP-12+YC-12(12A C13)

YP-12+YC-12(15A C13)

YP-12+YC-12(7A C13)

YP-12+YC-12L(11A C13)

YP-12+YC-12L(12A C13)

YP-12+YC-12L(15A C13)

YP-12+YC-12L(7A C13)

YP-12+YC-14(2.5A C5)

YP-12+YC-18(15A C19)

YP-17C+YC-18(11A C19)

YP-17C+YC-18(7A C19)

(以下空白)

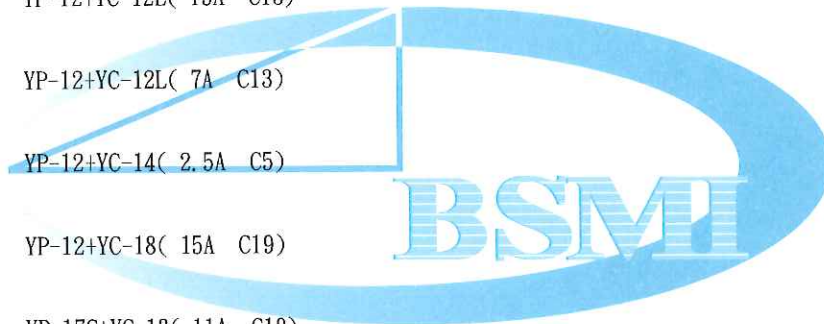



經濟部標準檢驗局

BUREAU OF STANDARDS, METROLOGY AND INSPECTION,
MINISTRY OF ECONOMIC AFFAIRS



商品驗證登錄證書

CERTIFICATE OF THE REGISTRATION OF PRODUCT CERTIFICATION

證書號碼： CI316065050417 號 99

Certificate No.

茲據 永力實業有限公司

申請驗證登錄，經審查結果符合規

定，准予登錄並使用商品安全標章及識別號碼：

R31505

。其登錄事項如下：

The application made by

YUNG-LI Co., Ltd

for Registration of Product

Certification has been reviewed and found to be in compliance with related regulations. Therefore, registration is granted with the

Product Safety Mark  and the Identification No.

R31505

. Details of the registration are follows :

申請人：永力實業有限公司

統一編號：22792569

Applicant

Uniform No.

地址：新北市汐止區新台五路一段99號7樓之12

Address

生產廠場：東莞永力電業有限公司

Factory

廠址：中國廣東省東莞市常平鎮崗梓大埔工業區

Factory Address

商品種類名稱：

Type/name of product

商品分類號列：8544.49.90.00.1-E

C. C. C Code

中文名稱：聚氯乙稀絕緣花線

Chinese name

英文名稱：PVC INSULATED CABLES

English name

型式：VCTF 0.75mm² ~2.0mm² / 2C、3C

Type

系列型式：HVCTF 0.75mm² ~2.0mm² / 2C、3C, HVCTFK 0.75mm² ~2.0mm² / 2C, VCTFK

Series of the type 0.75mm² ~2.0mm² / 2C(以下空白)

依據標準：CNS15663第五節含有標示(102年版)、CNS3199(83年版)

Standards

標準檢驗局發證(發證地址：100臺北市中正區濟南路1段4號)

This certificate is issued by the BSMI. (No.4, Sec. 1, Jinan Rd., Zhongzheng Dist., Taipei City 100, Taiwan)

登錄日期：中華民國 106 年 05 月 16 日

Registration Date 2017 (year) 05 (month) 16 (day)

本證書有效期限至 109 年 12 月 31 日

Expiration Date 2020 (year) 12 (month) 31 (day)

發證日期：中華民國 106 年 11 月 17 日

Date of issue 2017 (year) 11 (month) 17 (day)

註1：持本證書進口驗證登錄商品時，進口人須與本證書名義人相同。

註2：次年度商品驗證登錄年費繳納期限為當年11月30日，逾期未繳納者，經限期繳納屆期未繳納，即依商品檢驗法第42條第7款規定廢止驗證登錄，並自次年度1月1日起生效。