

# 東莞永力電業有限公司

YUNG LI CO., LTD

Da Pu Industrial Zone, Gang Zi, Changping Town,  
Dong Guan City, Guangdong 523571 China.P.R.C

TEL:0769-83396797~8

FAX:0769-83396796

E-mail: sales@yung-li.com

Description: YP-DE/YC-12

Customer: \_SY

Parts No. : 222UI?`?C?E\_

Draw No. :

## REVISION RECORD

1		
2		
3		
4		
5		

YUNG LI		
CHECKED	PREPARED	BY

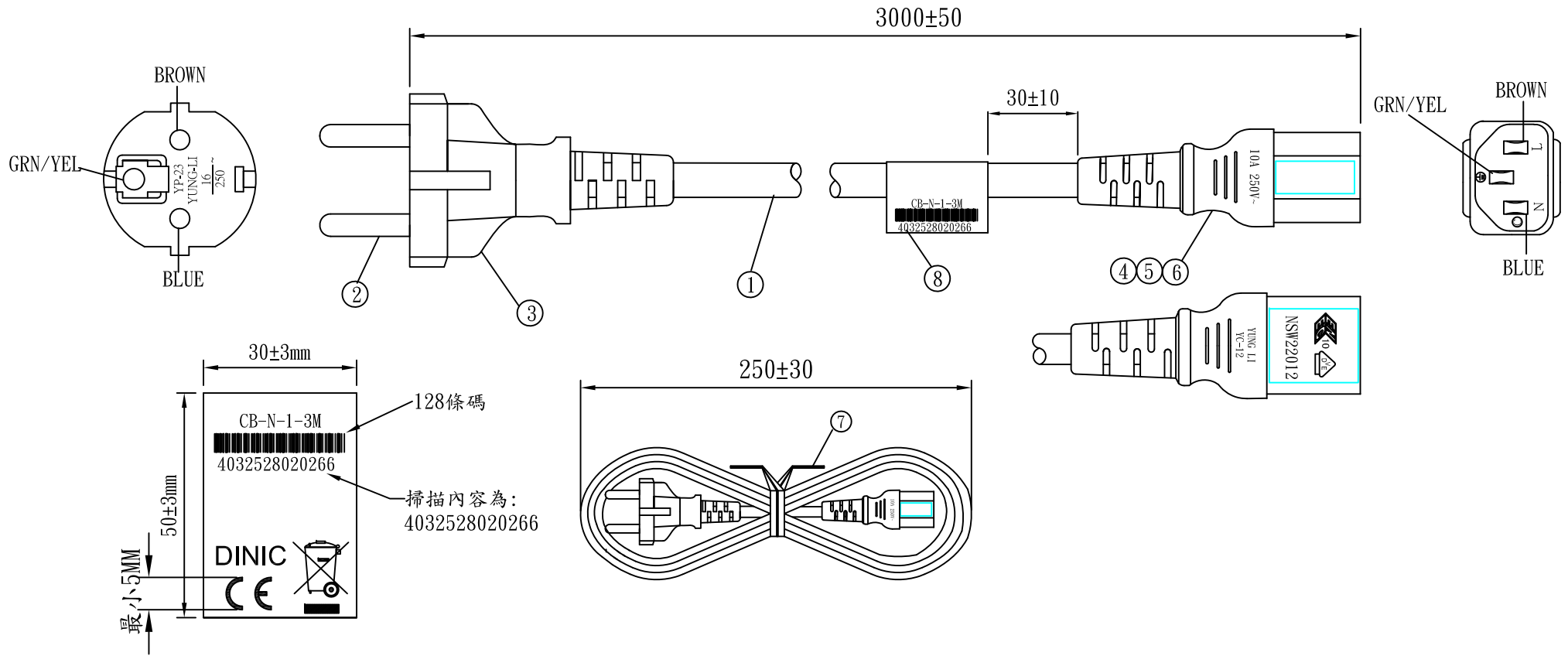

CUSTOMER	APPROVED

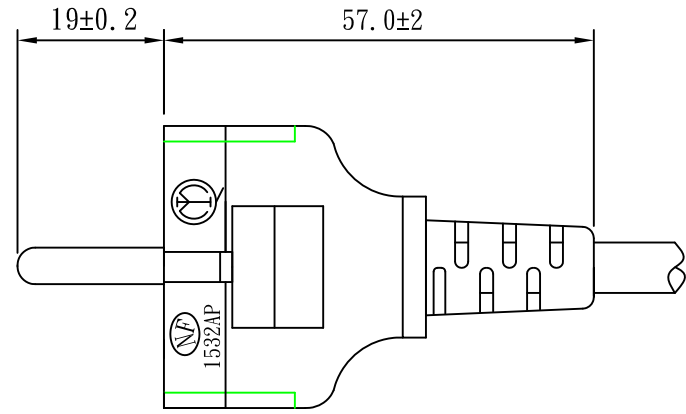
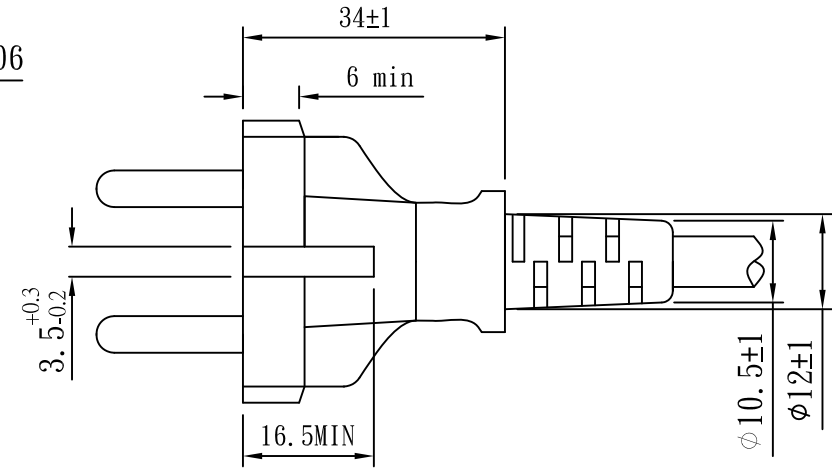
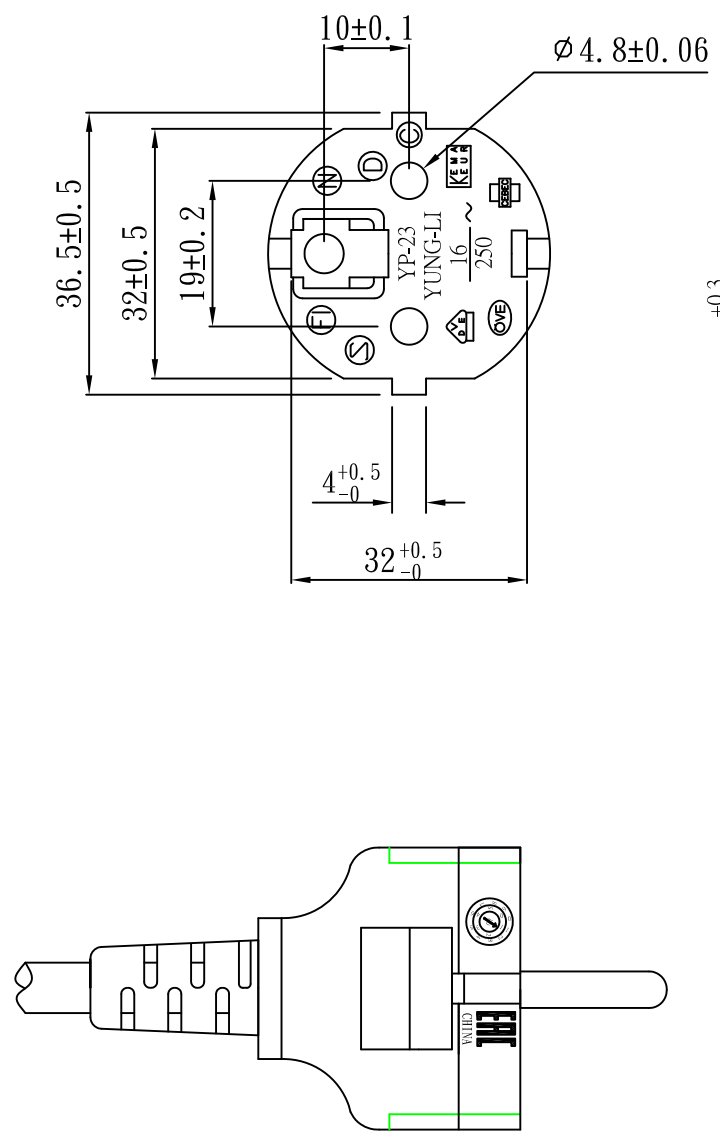

NO.	SPECIFICATION	QTY	REMARK
1	H05VV-F 1.0/3G BLACK	1PC	
2	TER:98651 BLACK	1PC	
3	YP-23 PVC PLASTIC:50P BLACK	32g/PC	
4	YC-12 PVC PLASTIC:50P BLACK	18g/PC	
5	"U" TER: 97740BS-0	3PCS	
6	YC-12 INNER BODY	1PC	
7	MINI TIE:L=180mm BLACK	1PC	
8	LABEL:50*30mm	1PC	

TOLERANCE >0±0.30 >1.0±0.50 >10.0±1.0 >20.0±2.0 Angle: ±1°	APPROVED		DATE		YUNG LI CO., LTD			
	CHECKED		DATE					
	DRAWN	SUKI	DATE	21.01.29	CUSTOMER	MAG		
	TYPE	YP-23/YC-12			P/N	CB-N-1-3M		
	DRAWING NO.	CY-V0208-01	REV	B	MATERIAL	P.V.C	UNIT	mm
				HEFT(g)				



TOLERANCE $>0 \pm 0.30$ $>1.0 \pm 0.50$ $>10.0 \pm 1.0$ $>20.0 \pm 2.0$ Angle: $\pm 1^\circ$	APPROVED		DATE		YUNG LI CO., LTD			
	CHECKED		DATE					
	DRAWN		DATE		CUSTOMER			
	TYPE	YP-23			P/N			
	DRAWING NO.	CY-P23V	REV	D	MATERIAL	P. V. C	UNIT	mm
				SCALE	1:1	 		



NSW22012

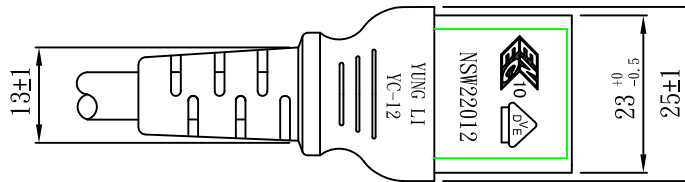
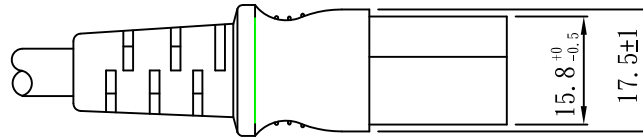
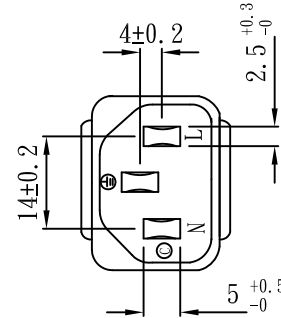
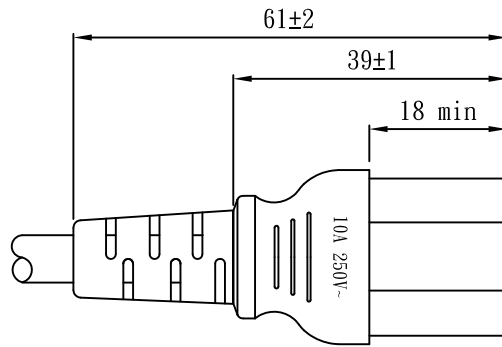

TOLERANCE >0±0.30 >1.0±0.50 >10.0±1.0 >20.0±2.0 Angle: ±1°	APPROVED		DATE		YUNG LI CO., LTD				
	CHECKED		DATE						
	DRAWN		DATE		CUSTOMER				
	TYPE	YC-12				P/N			
						MATERIAL	P. V. C	UNIT	mm
	DRAWING NO.		REV	B	SCALE	1:1			

# YUNG LI CO., LTD

## SPECIFICATION

Yung Li	Style	PVC FLEXIBLE CORDS	Document No
2019.04.16			
Edition	Size	<b>H05VV-F 3G 1.0mm<sup>2</sup></b>	Page
A			1/2

1. Standard: IEC 227 IEC228

2. Construction & Dimension

	Item	Specification
Conductor	Size	3G 1.0mm <sup>2</sup>
	Material	Annealed Bare Copper
	Construction	32/ $\phi$ 0.202±0.005
Insulation	Material	PVC
	Minimum Average Thickness	0.60mm
	Minimum Thickness at any point	0.48mm
	Diameter	2.50 ± 0.10
	Identification	Blue,Brown,Green/Yellow
Core Assembly	Core Twist	3-Core
	Filler	NA
	Assembly Pair	NA
Taping	Mylar Foil	NA
Shielded	A1-Mylar Foil	NA
Drain	Material	NA
	Construction	NA
Jacket	Material	NA
	Minimum Average Thickness	0.8mm
	Minimum Thickness at any point	0.58mm
	Overall Diameter(Approx)	7.0± 0.15
	Color	BLACK

**Marking:**

Yung Li Co., Ltd. H05VV-F 3G 1.0mm<sup>2</sup> <VDE> NF-USE 1347  KEMA-KEUR  CEBEC <OVE>

    IEMMEQU SAA-190646-EA  A004049 60227 IEC 53(RVV) 300/500V  SU01027-4002

# YUNG LI CO., LTD

## SPECIFICATION

Yung Li	Style	PVC FLEXIBLE CORDS	Document No
2019.04.16			
Edition	Size	<b>H05VV-F 3G 1.0mm<sup>2</sup></b>	Page
A			2/2

### 4. Electrical & Physical Properties

Item	Specification		
Rating Voltage	70°C 300/500V		
Conductor resistance(AT 20°C)	19.5Ω/Km MAX		
Insulation Resistance(AT 70°C)	0.010MΩ/Km Min		
Dielectric Strength	AC 2.0 KV / 15 min No Break		
Spark Test	5.0KV		
Insulation	Unaged	Tensile Strength	1.02 kgf/mm <sup>2</sup> min
		Elongation	150% Min
	Aged	Tensile Strength	80~120% (80°C x168hrs)
		Elongation	80~120% (80°C x168hrs)
	Loss of mass Test		2.0mg/cm <sup>2</sup> (max)
Jacket	Unaged	Tensile Strength	1.02 kgf/mm <sup>2</sup> min
		Elongation	150% Min
	Aged	Tensile Strength	80~120% (80°C x168hrs)
		Elongation	80~120% (80°C x168hrs)
	Loss of mass Test		2.0mg/cm <sup>2</sup> (max)
Deformation Test		70±4°C X 1hr ≤ 50%	
Cold Bend Test		-15°C x 4hr No Crack	
Heat Shock Test		150±2°C x 1hr No Crack	

### Graph:

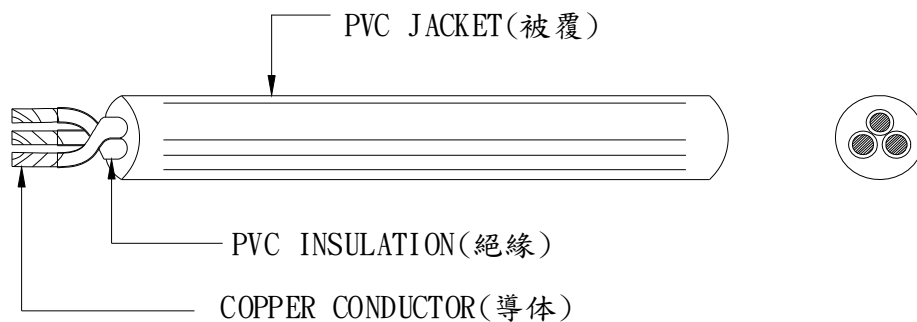

## ZEICHENGENEHMIGUNG MARKS APPROVAL

Yung-Li Co. Ltd.  
Da Pu Industrial Zone, Cang Zi  
Chang Ping Town  
523571 DONG GUAN CITY  
Guangdong  
CHINA

ist berechtigt, für ihr Produkt /  
*is authorized to use for their product*

**Stecker mit Schutzkontakt, nicht wiederanschließbar, umspritzt**  
***Plug, with earthing contact, non-rewirable, moulded***

die hier abgebildeten markenrechtlich geschützten Zeichen  
für die ab Blatt 2 aufgeführten Typen zu benutzen /  
*the legally protected Marks as shown below for the types referred to on page 2 ff.*



Geprüft und zertifiziert nach /  
*Tested and certified according to*

DIN VDE 0620-2-1 (VDE 0620-2-1):2016-01  
DIN VDE 0620-2-1/A1 (VDE 0620-2-1/A1):2017-09

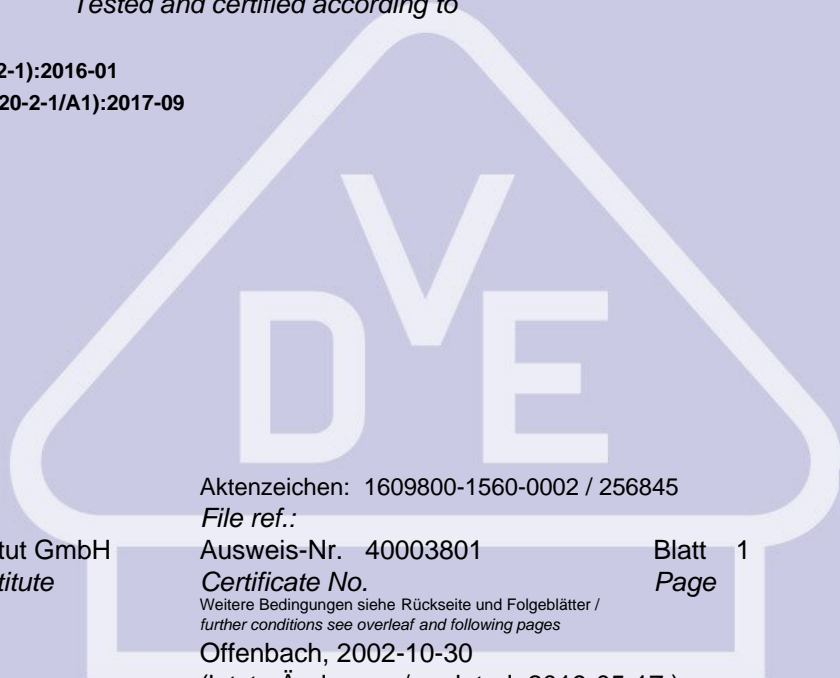

Aktenzeichen: 1609800-1560-0002 / 256845

File ref.:

Ausweis-Nr. 40003801

Blatt 1

Certificate No.

Page

Weitere Bedingungen siehe Rückseite und Folgeblätter /  
*further conditions see overleaf and following pages*

Offenbach, 2002-10-30

(letzte Änderung / updated 2019-05-17)

VDE Prüf- und Zertifizierungsinstitut GmbH  
VDE Testing and Certification Institute  
Zertifizierungsstelle / Certification

R. Nickel

VDE Zertifikate sind nur gültig bei Veröffentlichung unter:  
VDE certificates are valid only when published on:

<http://www.vde.com/zertifikat>  
<http://www.vde.com/certificate>

Name und Sitz des Genehmigungs-Inhabers / *Name and registered seat of the Certificate holder*

Yung-Li Co. Ltd., Da Pu Industrial Zone, Cang Zi, Chang Ping Town, 523571 DONG GUAN CITY, Guangdong, CHINA

Aktenzeichen / *File ref.*

1609800-1560-0002 / 256845 / TL3 / SHA

letzte Änderung / *updated*

2019-05-17

Datum / *Date*

2002-10-30

Dieses Blatt gilt nur in Verbindung mit Blatt 1 des Zeichengenehmigungsausweises Nr. 40003801.

*This supplement is only valid in conjunction with page 1 of the Certificate No. 40003801.*

## **Stecker mit Schutzkontakt, nicht wiederanschließbar, umspritzt** **Plug, with earthing contact, non-rewirable, moulded**

Typ(en) / *Type(s)*

### **YP-23**

Bemessungsspannung  
*Rated voltage*

AC 250 V

Bemessungsstrom  
*Rated current*

16 A

Polzahl  
*Number of poles*

2-polig mit zwei Schutzkontaktsystemen  
*2-pole with two earthing contact systems*

Bauart  
*Kind of construction*

DIN 49441-R2

Schutzart  
*Degree of protection*

IP 20

Produktinformation  
*Product information*

siehe Anlage Nr.: 300A + 900A vom 2019-05-17  
*see Appendix No.: 300A + 900A dated 2019-05-17*

VDE Prüf- und Zertifizierungsinstitut GmbH  
*VDE Testing and Certification Institute*  
Fachgebiet TL3  
*Section TL3*





# ÖVE-CERTIFICATE

including the entitlement to use the Austrian Safety Mark



Certificate No.: **21721-007-06**

Valid from: 2019 04 30  
until: 2021 04 30

The Austrian Electrotechnical Association (OVE) hereby grants the right to the company mentioned below to label the listed products with the Austrian Safety Mark.

Company: **Yung Li Co. Ltd.**  
Da Pu Industrial Zone, Gang Zi, Chang Ping Town  
523571 Dong Guan City, Guang Dong Province  
China

Product: **Non rewirable two pole plug with dual earthing system**

The products submitted by the applicant were type tested in accordance with the requirements of the technical standards and specifications listed in this certificate. OVE certifies the conformity of the listed products and those products manufactured strictly identical to the submitted ones (EN ISO/IEC 17067, Conformity Assessment Scheme Type 5).

The manufacturing process and the products are subject to ongoing surveillance based on harmonized European procedures. This certificate has been issued under the presumption and conditional on the fact that the applicant holds all necessary legal rights with regard to the product, presented for the testing and certification.

Results of testing are shown in file No(s): **1776-1199/03**

**Österreichischer Verband für Elektrotechnik**  
Head of Testing and Certification

Digitally signed by W. Martin  
Email=w.martin@ove.at

Dipl.-Ing. W. Martin

Wien, 2019 02 20



## OVE Testing and Certification

Accredited by the Federal Ministry for Digital and Economic Affairs as Certification Body for products within the scope as given in the official decree and published under [www.bmdw.gv.at/akkreditierung](http://www.bmdw.gv.at/akkreditierung).



**Manufacturer:**

Yung Li Co. Ltd.  
Da Pu Industrial Zone, Gang Zi, Chang Ping Town  
523571 Dong Guan City, Guang Dong Province  
China

**Factory location(s):**

Yung Li Co. Ltd.  
Da Pu Industrial Zone, Gang Zi, Chang Ping Town  
523571 Dong Guan City, Guang Dong Province  
China

**Tested and certified according to:**

ÖVE/ÖNORM IEC 60884-1:2005-09-01

**Product: Non rewirable two pole plug with dual earthing system**

**Type designation:**

**Rating:**

**Trademark:**

**YP-23**

Rated voltage: AC 250 V  
Rated current: 16 A  
H03VV-F 3 G 0,75

YUNG LI

**YP-23**

Rated voltage: AC 250 V  
Rated current: 16 A  
H05VV-F 3 G 0,75

YUNG LI

**YP-23**

Rated voltage: AC 250 V  
Rated current: 16 A  
H05VV-F 3 G 1

YUNG LI

**YP-23**

Rated voltage: AC 250 V  
Rated current: 16 A  
H05VV-F 3 G 1,5

YUNG LI

**OVE Testing and Certification**

Accredited by the Federal Ministry for Digital and Economic Affairs as Certification Body for products within the scope as given in the official decree and published under [www.bmdw.gv.at/akkreditierung](http://www.bmdw.gv.at/akkreditierung).



**L C I E**

Accréditation  
N° 5-0014  
Portée  
disponible sur  
www.cofrac.fr



# LICENCE



LCIE N° 621359

**Délivrée à:**  
*Delivered to:* **YUNG LI Co., Ltd**  
**1F, No 10, Lane 235, Pao-Chiang Road, Hsin-Tien - TAIPEI - TAIWAN**

**Site de fabrication:**  
*Factory:* **YUNG LI Co., Ltd. (1532AP)**  
**Da Pu Industrial Zone, Gang Zi, Chang Ping Town - Dong Guan City - GUANG DONG PROVINCE 523571 - CHINE**

**Produit:**  
*Product:* **Fiche de prise de courant**  
**Plug**

**Marque commerciale (s'il y a lieu):**  
*Trade mark (if any):* **YUNG-LI**

**Modèle, type, référence:**  
*Model, type, reference:* **YP-23**

**Caractéristiques nominales et principales:**  
*Rating and principal characteristics:* **16A 250V~, 2P avec contact de terre/2P with dual earthing contact**  
**voir annexe/see annex**

**Informations complémentaires:**  
*Additional informations:* **Mise à jour suite à évolution de la norme**  
**update further to the evolution of the standard**

**Le produit est conforme à:**  
*The product is in conformity with:* **NF C 61-314:2008 +A1:2010**

**Documents pris en compte:**  
*Relevant documents:* **Rapport d'essai/test report n°BVCB11DE1039ACSP, certific d'essai**  
**OC/CB test certificate n°DE1-41647 / TR 1609800-1560 -0002/115256**

**Annule et remplace (s'il y a lieu):**  
*Cancel and replaces (if necessary):* **Licence n°555294/1 du 2007-02-26**

En vertu de la présente décision notifiée par le LCIE France organisme mandaté, AFNOR Certification accorde le droit d'usage de la Marque NF à la société qui en est titulaire pour les produits visés ci-dessus, dans les conditions définies par les règles générales de la Marque NF et par les règles de certification NF, pour autant que les contrôles réguliers de la fabrication et les vérifications par tierce partie soient satisfaisants.

On the strength of the present decision notified by LCIE France mandated certification body, AFNOR Certification grants the right to use the NF Mark to the licence holder for the above mentioned products, within the frame of the general rules of the NF Mark and of the NF certification rules, as far as the regular checking and third party verifications of the production are satisfactory.

Fontenay-aux-Roses, 2012-01-11

**Michel BRENON**  
Directeur de la Certification  
Certification Manager

**Date limite de validité:**  
*Limit expired date:*

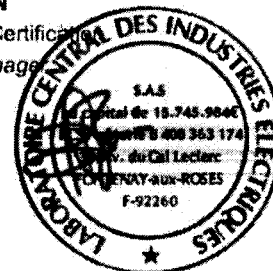

La validité de la présente licence cesse dès l'annulation de l'une des normes sur laquelle elle est fondée.  
*The present licence is valid until the cancellation of one of the standards on which it is based.*

Product	Plugs
Applicant	Yung Li Co., Ltd. China Da Pu Industrial Zone, Chang Ping Town, Dong Guan City, Guangdong Province 523571 China
Manufacturer	Yung Li Co., Ltd. China Da Pu Industrial Zone, Chang Ping Town, Dong Guan City, Guangdong Province 523571 China
Factory	Yung Li Co., Ltd. China Da Pu Industrial Zone, Chang Ping Town, Dong Guan City, Guangdong Province 523571 China
Ratings	16A 250V AC
Trade mark	YUNG LI
Model / Type Ref.	YP-23
Principal characteristics	Non-rewirable plug, Standard Sheet VII, with H03VV-F 3G0,75mm <sup>2</sup>
A sample of the product was tested and found to be in conformity with	INST IEC 60884-1:2002, IEC 60884-1:2002/AMD1:2006, IEC 60884-1:2002/AMD2:2013 NEK 502:2016
Validity	This certificate documents conformity with the standards shown, and also applies as license for use of Nemkos name and certification mark. The certificate and license is valid as long as the applicable conditions are complied with, and provided that any changes to the product are notified to Nemko for acceptance prior to implementation. New standards or amendments to the standards may imply that the product design must be updated and/or that re-testing and re-certification is necessary.
Additional information	
Additional model(s)	(4) See page 2

Date of issue 01-03-2017



Sweet Yuan

Certification Department

**Nemko AS**

Gaustadalléen 30, P.O. Box 73 Blindern, 0314 Oslo, Norway  
TEL +47 22 96 03 30 FAX +47 22 96 05 50 EMAIL info@nemko.com  
ENTERPRISE NUMBER NO974404532

Additional model(s)

Product	Plugs
Pos. No	1
Model / Type Ref.	YP-23
Trade mark (if different from page 1)	
Rating	16A 250V AC
Principal characteristics	Non-rewirable plug, Standard Sheet VII, with H03V2V2-F 3G0.75mm <sup>2</sup>
Product	Plugs
Pos. No	2
Model / Type Ref.	YP-23
Trade mark (if different from page 1)	
Rating	16A 250V AC
Principal characteristics	Non-rewirable plug, Standard Sheet VII, with H05VV-F 3G0.75-1-1.5mm <sup>2</sup>
Product	Plugs
Pos. No	3
Model / Type Ref.	YP-23
Trade mark (if different from page 1)	
Rating	16A 250V AC
Principal characteristics	Non-rewirable plug, Standard Sheet VII, with H05V2V2-F 3G0.75-1-1,5mm <sup>2</sup>
Product	Plugs
Pos. No	4
Model / Type Ref.	YP-23
Trade mark (if different from page 1)	
Rating	16A 250V AC
Principal characteristics	Non-rewirable plug, Standard Sheet VII, with H05RN-F 3G0.75-1mm <sup>2</sup>

Date of issue 01-03-2017



Sweet Yuan

Certification Department

**Nemko AS**

Gaustadalléen 30, P.O. Box 73 Blindern, 0314 Oslo, Norway  
TEL +47 22 96 03 30 FAX +47 22 96 05 50 EMAIL info@nemko.com  
ENTERPRISE NUMBER NO974404532

# DEMKO CERTIFICATE

<b>Certificate No.</b>	D-05357
<b>Page</b>	1/3
<b>Date of Issue</b>	2016-07-18
<b>Certificate Holder</b>	Yung-Li Co., Ltd. Da Pu Industrial Zone, Gangzi Chang Ping Town Dongguan, 523571 GUANGDONG CHINA
<b>Manufacturer</b>	Yung-Li Co., Ltd. Da Pu Industrial Zone, Gangzi Chang Ping Town Dongguan, 523571 GUANGDONG CHINA
<b>Production site</b>	Yung-Li Co., Ltd. Da Pu Industrial Zone, Gangzi Chang Ping Town Dongguan, 523571 GUANGDONG CHINA
<b>Certified Product Model</b>	Plug, non-rewirable YP-23 See Page 2
<b>Trademark</b>	YUNG LI
<b>Rated Voltage / Frequency</b>	250 V~
<b>Rated Current / Power</b>	16 A
<b>Insulation Class</b>	-
<b>Degree of protection (IP)</b>	20
<b>Tested acc. to</b>	DS 60884-2-D1:2011
<b>Test Report No.</b>	NCS/FI 29582 issued on 2016-06-13
<b>Additional</b>	This certificate replaces previous certificate D-02484
<b>Expire date</b>	2021-06-13

**Certification Manager**  
Jan-Erik Storgaard

This is to certify that representative sample(s) of the Product described herein ("Certified Product") have been investigated and found in compliance with the Standard(s) indicated on this Certificate, in accordance with the D Mark Requirements. The Designated Certificate holder is entitled to use the d or for cables <DEMKO> for the Certified Product manufactured at the production site(s) identified above, in accordance with the D Mark Service Agreement, including without limitation the D Mark Testing and Certification Services Service Terms. Only those Products bearing the D Mark should be considered as being covered by UL's D Mark Service. This Certificate shall remain valid through the expiration date, unless terminated earlier in accordance with the Service Agreement including without limitation if the Standard identified on this Certificate is amended or withdrawn prior the expiration date.

**Certification Body**

UL International Demko A/S, Borupvang 5A, DK-2750  
Ballerup, Denmark, Tel. +45 44 85 65 65,  
info.dk@ul.com  
www.ul-europe.com



# Appendix DEMKO CERTIFICATE

**Certificate No.** D-05357  
**Page** 2/3  
**Date of Issue** 2016-07-18

**Model Details:**

YP-23 with cord  
H03VV-F 3G0,75  
H03V2V2-F 3G0,75  
H05VV-F 3G0,75-1-1 ,5  
H05V2V2-F 3G0,75-1-1,5  
H05RN-F 3G0,75-1

**External Certification Information:**

This is based on certificate No. NCS/FI 29582 date on 2016-06-13 issued by SGS Fimko Ltd.

**Additional Information:**

Standard sheet CEE 7 / VII

---

**Certification Body**

UL International Demko A/S, Borupvang 5A, DK-2750  
Ballerup, Denmark, Tel. +45 44 85 65 65, info.dk@ul.com  
[www.ul-europe.com](http://www.ul-europe.com)



# Appendix DEMKO CERTIFICATE

Certificate No. D-05357  
Page 3/3  
Date of Issue 2016-07-18

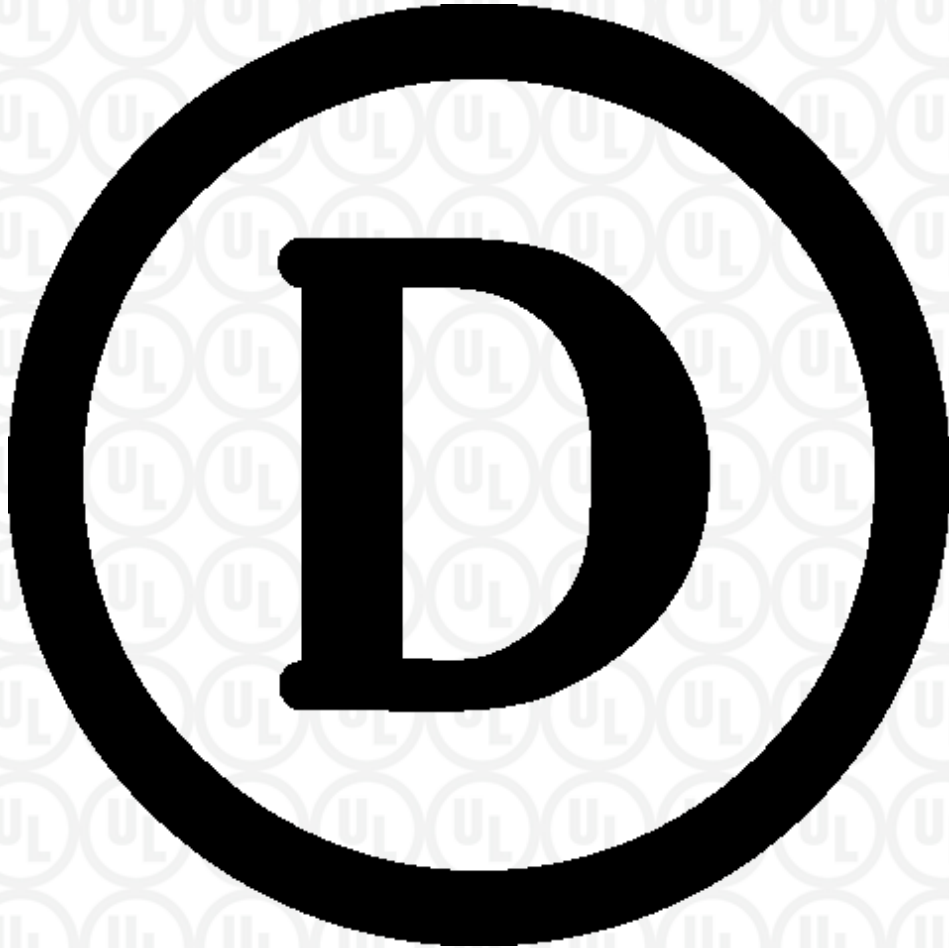

---

**Certification Body**

UL International Demko A/S, Borupvang 5A, DK-2750  
Ballerup, Denmark, Tel. +45 44 85 65 65, info.dk@ul.com  
www.ul-europe.com





# Certificate



for European Product Safety

Reference No. 1600038

## Plug, non rewirable

Type designation	YP-23
Certificate holder	<b>YUNG LI CO. LTD. DA PU INDUSTRIAL ZONE GANGZI CHANG PING TOWN DONGGUAN, 523571 GUANGDONG CHINA</b>
The product complies with the standard(s)	IEC 60884-1:2002 + A1 + A2 SS 428 08 34:2013
Date of expiry	12 February 2021

Additional information in Appendix.

Certification Body	Intertek Semko AB, Product Certification	Place	Kista - Stockholm
Signed	 Bo Berglöf	Date	12 February 2016 Page 1 of 2

This certificate is issued in accordance with the terms and conditions set out in the Appendix.



# Intertek Appendix

Reference No. 1600038

### Technical data

Type designation	YP-23
Rated voltage (V)	250~
Rated current (A)	16
IP-Class	20
Type of cord	H03V2V2-F 3G0,75mm <sup>2</sup> H05V2V2-F 3G0,75-1,5mm <sup>2</sup> H03VV-F 3G0,75mm <sup>2</sup> H05VV-F 3G0,75-1,5mm <sup>2</sup>
Standard sheet	CEE 7/VII
Trade mark	YUNG-LI
Product information	Non rewirable plug for class I equipment. With straight cord entry.

Manufacturing site(s) YUNG LI CO. LTD.  
DA PU INDUSTRIAL ZONE  
GANGZI CHANG PING TOWN  
DONGGUAN, 523571 GUANGDONG  
CHINA

This certificate replaces previously issued ref. No. 1218960 dated 2012-12-28 for YUNG LI CO., LTD. A new certificate has been issued on account of updating the standard.

The certificate applies for countries that have sanctioned the use of plugs/outlets according to subject standard sheet and component standard.

Certification Body Intertek Semko AB, Product Certification Place Kista - Stockholm

Signed  Date 12 February 2016  
Bo Bergl f

*This Certificate is for the exclusive use of Intertek's Client and is provided pursuant to the Certification agreement between Intertek and its Client. Intertek's responsibility and liability are limited to the terms and conditions of the agreement. Intertek assumes no liability to any party, other than to the Client in accordance with the agreement, for any loss, expense or damage occasioned by the use of this certificate. Only the Client is authorized to permit copying or distribution of this certificate and then only in its entirety. Use of Intertek's Certification mark is restricted to the conditions laid out in the agreement. Any further use of the Intertek name for the sale or advertisement of the tested material, product or service must first be approved in writing by Intertek. Initial Factory Assessments and Follow up Services are for the purpose of assuring appropriate usage of the Certification mark in accordance with the agreement, they are not for the purposes of production quality control and do not relieve the Client of their obligations in this respect.*

# CERTIFICATE

Issued to:  
Applicant:  
**Yung Li Co., Ltd.**  
Da Pu Industrial Zone, Chang Ping Town  
523571 Dongguan City, China

Manufacturer/Licensee:  
**Yung Li Co., Ltd.**  
Da Pu Industrial Zone, Chang Ping Town  
523571 Dongguan City, China

Product(s) : plug, (2-pole)  
Trade name(s) : YUNG-LI  
Type(s)/model(s) : YP-23

The product and any acceptable variation thereto is specified in the Annex to this certificate and the documents therein referred to.

- DEKRA hereby declares that the above-mentioned product has been certified on the basis of
- a type test according to the standard IEC 60884-1:2002 +A1:2006 + A2:2013 and NEN 1020:1987 + A2:2004;
  - an inspection of the production location according to CENELEC Operational Document CIG 021
  - a certification agreement with the number 2078870

DEKRA hereby grants the right to use the KEMA-KEUR certification mark.

The KEMA-KEUR certification mark may be applied to the product as specified in this certificate for the duration of the KEMA-KEUR certification agreement and under the conditions of the KEMA-KEUR certification agreement.

This certificate is issued on 30 August 2013 and expires upon withdrawal of one of the above mentioned standards.

Certificate number: 2164611.01

DEKRA Certification B.V.



drs. G.J. Zoetbrood  
Managing Director



H.R.M. Barends  
Certification Manager

© Integral publication of this certificate is allowed

ACCREDITED BY  
THE DUTCH COUNCIL  
FOR ACCREDITATION





# CERTIFICATE NCS/FI 29582

Our Ref. 284214-2

**Product** Plug, non-rewirable

**Type** YP-23, with cord H03VV-F 3G0,75  
 YP-23, with cord H03V2V2-F 3G0,75  
 YP-23, with cord H05VV-F 3G0,75-1-1,5  
 YP-23, with cord H05V2V2-F 3G0,75-1-1,5  
 YP-23, with cord H05RN-F 3G0,75-1

**Trade mark** YUNG LI

**Certificate Holder/  
 Manufacturer** Yung-Li Co., Ltd.  
 Da Pu Industrial Zone, Gangzi Chang Ping Town  
 Dongguan, 523571 GUANGDONG  
 CHINA

**Technical information** 16 A, 250 V~, IP20

**Other information** Standard sheet CEE 7 / VII

**The product is certified  
 according to the following  
 standard(s)** IEC 60884-1:2002 (Ed 3) + A1:2006 + A2:2013  
 SFS 5610:2015

**Validity** This certificate is valid until 13 June 2021 unless the standard in question has been amended or superseded with significant changes in requirements, in which case, SGS Fimko has the right to shorten the validity of the certificate based on the legislation of the European Union. This certificate includes the right to use the FI mark under the condition that changes (if any) will be checked at SGS Fimko before the product is brought onto market and that the conditions for FI certification are met.

**Date of issue** 13 June 2016

**Signature**   
 SGS Fimko Ltd  
 Sixten Lökfors  
 Project Manager



This certificate has 1 appendix



This certificate is issued by the company under its General Conditions for Certification Services accessible at <http://www.sgs.fi/en/Terms-and-Conditions.aspx>. Attention is drawn to the limitations of liability defined therein and in the Test Report here above mentioned which findings are reflected in this certificate. Any unauthorized alteration, forgery or falsification of the content or appearance of this document is unlawful and offenders may be prosecuted to the fullest extent of the law.

# LICENCE

No. 18294 replaces No.13085

Issued to:  
Applicant:  
**Yung Li Co. Ltd.**  
1F, No.10, Lane 235,  
Pao-Chiao Road  
Hsin-Tien, New Taipei, Taiwan

Licensee:  
**Yung Li Co. Ltd.**  
1F, No.10, Lane 235,  
Pao-Chiao Road  
Hsin-Tien, New Taipei, Taiwan



Product : plugs (2-pole) for household purposes  
Trade name(s) : YUNG-LI  
Type(s)/model(s) : YP-23

The product and any acceptable variation thereto is specified in the annex to this licence and the documents therein referred to.

SGS CEBEC hereby declares that the above-mentioned product has been certified on the basis of:

- a type test according to the standard specified in annex
- an inspection of the production location
- a certification agreement with the number 1031

SGS CEBEC hereby grants the right to use the CEBEC certification mark

The CEBEC certification mark may be applied to the product as specified in this licence for the duration of the CEBEC certification agreement and under the conditions of the CEBEC certification agreement.

This licence is issued on: 03/04/2013

ir. C. Lana,  
Certification Manager

© Only integral publication of this certificate, including the annex, is allowed  
This certificate is only valid combined with the publication on the following web address: [www.sgs.com/ee](http://www.sgs.com/ee)

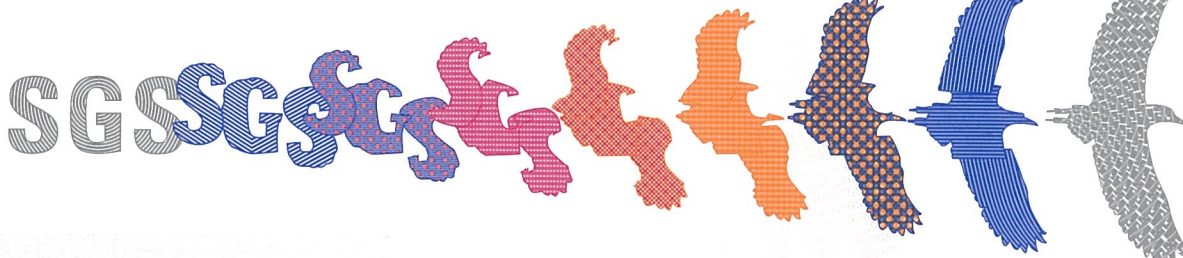

## SPECIFICATION OF THE CERTIFIED PRODUCT

### Product data

Product	:	plugs (2-pole) for household purposes
Trade name(s)	:	YUNG-LI
Type(s)/Model(s)	:	YP-23
rated current (In)	:	16 A
rated voltage (Un)	:	250 Vac
earthing design	:	with dual earthing system
class	:	for class I appliances
standard sheet	:	VII of CEE7
applied flexible cord(s)	:	H03 VV-F 3 G 0.75 mm <sup>2</sup> H05 VV-F 3 G 0.75-1.5 mm <sup>2</sup> H03V2V2-F 3 G 0,75 mm <sup>2</sup> H05V2V2-F 3 G 0,75-1.5 mm <sup>2</sup>
cord(s) termination	:	crimped connection
description	:	body of thermoplastic material
certification mark	:	complies with the requirements
markings	:	are shown on the body

### Additional information

Insert: PBT 4115, Chang Chun  
Moulding: PVC Flex 60 O, Pure Friend

## TESTS

### Test requirements

NBN C 61-112-1 based on IEC 60884-1:2002 + A1:2006

### Test results

The test results are laid down in certification file ref.596814/01

**Remarks**

This certificate is based on certificate ref. CB SE-71544 and test report(s) ref. 1218960-1

**Conclusion**

The examination proved that all test requirements were met.

Checked by, project leader : Zanutto Luigi - 03/04/2013

Department Manager,  
Product Certification :

Certification Manager :

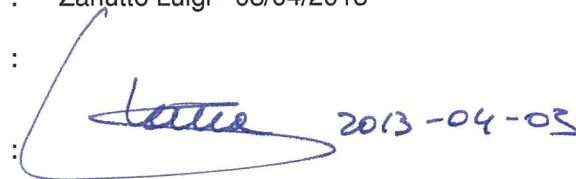

*Zanutto* 2013-04-03

**FACTORY LOCATION(S)**

Yung Li Co., Ltd.  
Da Pu Industrial Zone, GanZi  
Chang Ping Town, Dong Guan City  
523571 Guang Dong Province  
China



PID:  
02113100  
CID:  
C.1996.5269

## Certificato di approvazione

### Approval certificate

**IMQ, ente di certificazione accreditato,  
autorizza la ditta**

*IMQ, accredited certification body, grants to*

**YUNG LI CO., LTD.  
DA PU IND. ZONE, GangZi, CHANG PING TOWN  
DONG GUAN CITY, GUANG DONG PROV.  
CN - China**

**all'uso del marchio**

*the licence to use the mark*

**IMQ**

Il presente certificato è  
soggetto alle condizioni  
previste nel "Regolamento  
IMQ - Certificazione  
prodotto" ed è relativo ai  
prodotti descritti  
nell'Allegato al presente  
certificato.



**per i seguenti prodotti**

*for the following products*

**Spine indissolubilmente  
collegate al cavo  
( Rif. di tipo YP-23 )**

*Non-rewirable plugs  
( Type ref. YP-23 )*

*This certificate is subjected to  
the conditions foreseen by "IMQ  
Rules - Product Certification"  
and is relevant to the products  
listed in the annex to this  
certificate.*

Emesso il | Issued on **2003-06-25**  
Aggiornato il | Updated on **2011-09-21**  
Sostituisce | Replaces **2008-08-05**

  
**IMQ S.p.A.**

**Allegato - Certificato di approvazione**  
**Annex - Approval certificate**

*Emesso il / Issued on* 2003-06-25  
*Aggiornato il / Updated on* 2011-09-21  
*Sostituisce / Replaces* 2008-08-05

**Prodotto | Product**

***Spine indissolubilmente collegate al cavo***  
***Non-rewirable plugs***

**Concessionario | Licence Holder**

**YUNG LI CO., LTD.**  
**DA PU IND. ZONE, GangZi, CHANG PING TOWN**  
**DONG GUAN CITY, GUANG DONG PROV.**  
**CN - China**

**Marchio | Mark**



IMQ

**Costruito a | Manufactured at**

PI.B000M3 C01175219

DONG GUAN CITY, GUANG DONG PROV.

China

*Copia del presente certificato deve essere conservata presso i luoghi di produzione sopra elencati.*

*Copy of this certificate must be available at the manufacturing places listed above*

**Norme**

CEI 23-50 - II Ed. 2007 + V1:2008

**Standards**

CEI 23-50 - II Ed. 2007 + V1:2008

**Rapporti | Test Reports**

26LL00073

**Caratteristiche tecniche | Technical characteristics**

*Designazione | Type designation* **2P+T+T S31 / 2P+E+E S31**  
*Tensione nominale | Rated voltage* **250 V**  
*Corrente nominale | Rated current* **16 A**  
*Grado di protezione | Degree of protection (IP)* **IP20**  
*Tipo di morsetti | Type of terminals* **morsetti aggraffati / crimped connections**  
*Materiale della custodia | Material of the cover* **termoplastico / thermoplastic**  
*Uscita cavo | Cable exit* **assiale / straight**

**Articoli (con dettagli) | Articles (with details)**

AR.D006AZ

*Marca | Trade mark* **YUNG LI**  
*Riferimento di tipo | Type reference* **YP-23**  
*Articolo/Riferimento a catalogo | Article/Catalogue reference* **YP-23**  
*Tipo di cavo | Type of cable* **H03VV-F**  
*Sezione nominale | Section areas* **3G0,75 mm<sup>2</sup>**

AR.D006B0

*Marca | Trade mark* **YUNG LI**  
*Riferimento di tipo | Type reference* **YP-23**  
*Articolo/Riferimento a catalogo | Article/Catalogue reference* **YP-23**  
*Tipo di cavo | Type of cable* **H05VV-F**  
*Sezione nominale | Section areas* **3G0,75 mm<sup>2</sup>**

AR.D006B1

*Marca | Trade mark* **YUNG LI**  
*Riferimento di tipo | Type reference* **YP-23**

Articolo/Riferimento a catalogo | Article/Catalogue reference **YP-23**  
Tipo di cavo | Type of cable **H05VV-F**  
Sezione nominale | Section areas **3G1 mm<sup>2</sup>**

SN.D0009N.1

Marca | Trade mark **YUNG LI**  
Riferimento di tipo | Type reference **YP-23**  
Articolo/Riferimento a catalogo | Article/Catalogue reference **YP-23**  
Tipo di cavo | Type of cable **H05VV-F**  
Sezione nominale | Section areas **3G1,5 mm<sup>2</sup>**

## Ulteriori informazioni | Additional Information

La spina rif. di tipo YP-23 è prodotta col seguente inserto:  
marca: GEM ; art.: P98651.

The non-rewirable plug type ref. YP-23 is manufactured with the following insert:  
trade mark: GEM; art.: P98651.

## Componenti | Component List

### Rif. di tipo/Type ref. YP-23

Tipo   Type	(*)	Costruttore   Manufacturer	Riferimento   Type Ref.	Dati   Data	Norme   Standard (*)	Marchi   Marks
Cavo / Cable	2/4	YUNG LI CO. LTD.	YUNG LI	H03VV-F 3G0,75mm <sup>2</sup>	-	IMQ
Cavo / Cable	2/4	YUNG LI		H03VV-F	-	IMQ
Cavo / Cable	2/4	YUNG LI		H05VV-F	-	IMQ
Cavo / Cable	2/4	YUNG LI CO. LTD.	YUNG LI	H05VV-F 3G0,75 - 1 - 1,5mm <sup>2</sup>	-	IMQ

Emesso il | Issued on **2011-09-21**

Data di aggiornamento | Updated on

Sostituisce | Replaces

Ciascun componente è contraddistinto da un numero avente il seguente significato:

- 1 - Componente marchiato e sostituibile con altro pure marchiato con caratteristiche equivalenti
- 2 - Componente sostituibile solo previa autorizzazione dell'IMQ
- 3 - Componente (integrato nell'apparecchio utilizzatore) provato congiuntamente all'apparecchio utilizzatore
- 4 - Componente in alternativa
- 5 - Componente per uso opzionale
- 6 - Componente da abbinare

Each component is signed by a number having the following meaning:

- 1 - Approved component replaceable with another one also approved with equivalent characteristics
- 2 - Component replaceable with IMQ authorization only
- 3 - Integrated component tested together with appliances
- 4 - Alternative component
- 5 - Component for optional use
- 6 - Component to be matched

(\*) Queste colonne sono compilate a cura di IMQ / These columns are filled in by IMQ

## Diritti di concessione | Annual Fees

SN.D0009N

BTL.021100.DA19

Diritti modelli IMQ - 0211 - Prese, spine e connettori di uso domestico | IMQ models - 0211 - Plugs and appliance couplers for domestic purposes

1



**IMQ S.p.A.**

# ЕВРАЗИЙСКИЙ ЭКОНОМИЧЕСКИЙ СОЮЗ



## СЕРТИФИКАТ СООТВЕТСТВИЯ

№ ЕАЭС ВУ/112 02.01. 020 09041

Серия ВУ № 0007501

### ОРГАН ПО СЕРТИФИКАЦИИ

Открытое акционерное общество «Испытания и сертификация бытовой и промышленной продукции «БЕЛЛИС»; место нахождения: Республика Беларусь, 220029, г. Минск, ул. Красная, 7Б; место осуществления деятельности: Республика Беларусь, 220029, г. Минск, ул. Красная, 8; аттестат аккредитации № ВУ/112.020.02 от 03.08.1993; номер телефона: +243 17 243 16 41; адрес электронной почты: bellis@bellis.by

### ЗАЯВИТЕЛЬ

Yung Li Co., Ltd., Da Pu Industrial Zone, Chang Ping Town, Dong Guan City, Guangdong, 523571, Китай

номер телефона: +86-769-83335989; адрес электронной почты: eng@yung-li.com

### ИЗГОТОВИТЕЛЬ

Yung Li Co., Ltd., Da Pu Industrial Zone, Chang Ping Town, Dong Guan City, Guangdong, 523571, Китай

### ПРОДУКЦИЯ

Вилка штепсельная неразборная с заземляющим контактом «YUNG LI» модели УР-22, УР-23

серийный выпуск

КОД ТН ВЭД ЕАЭС 8544 42

### СООТВЕТСТВУЕТ ТРЕБОВАНИЯМ

Технический регламент Таможенного союза «О безопасности низковольтного оборудования» ТР ТС 004/2011;

### СЕРТИФИКАТ СООТВЕТСТВИЯ ВЫДАН НА ОСНОВАНИИ

протокола аккредитованной испытательной лаборатории «БЕЛЛИС», ВУ/112 1.0001, № 101-19-2255 от 26.09.2019,

отчета о проверке производства № 07-386/2019 от 26.09.2019

Схема сертификации: 1с

**ДОПОЛНИТЕЛЬНАЯ ИНФОРМАЦИЯ** ГОСТ ИЕС 60884-1-2013 Соединители электрические штепсельные бытового и аналогичного назначения. Часть 1. Общие требования и методы испытаний.

При поставках продукции на рынок стран ЕАЭС следует сообщить в орган по сертификации реквизиты компании-импортера (резидента страны ЕАЭС), которая является в соответствии с законодательством ответственной за качество поставляемой продукции, для дальнейшего включения этой информации в сертификат.

**СРОК ДЕЙСТВИЯ С 30.09.2019 ПО 29.09.2024 ВКЛЮЧИТЕЛЬНО**

Руководитель (уполномоченное лицо)  
органа по сертификации

Эксперт (эксперт-аудитор)  
(эксперты (эксперты- аудиторы))



Раковский  
Александр Григорьевич  
(Ф.И.О.)

Пепик  
Ольга Иосифовна  
(Ф.И.О.)

## ZEICHENGENEHMIGUNG MARKS APPROVAL

Yung-Li Co. Ltd.  
Da Pu Industrial Zone, Cang Zi  
Chang Ping Town  
523571 DONG GUAN CITY  
Guangdong  
CHINA

ist berechtigt, für ihr Produkt /  
*is authorized to use for their product*

**Gerätesteckdose, nicht-wiederanschließbar**  
**Connector, non-rewirable**

die hier abgebildeten markenrechtlich geschützten Zeichen  
für die ab Blatt 2 aufgeführten Typen zu benutzen /  
*the legally protected Marks as shown below for the types referred to on page 2 ff.*



Geprüft und zertifiziert nach /  
*Tested and certified according to*

DIN EN 60320-1 (VDE 0625-1):2016-04; EN 60320-1:2015+AC:2016  
DIN EN 60320-3 (VDE 0625-3):2015-11; EN 60320-3:2014  
IEC 60320-1:2015  
IEC 60320-3:2014



Aktenzeichen: 1609800-1550-0003 / 232784

File ref.:

Ausweis-Nr. 40029577

Blatt 1

Certificate No.

Page

Weitere Bedingungen siehe Rückseite und Folgeblätter /  
*further conditions see overleaf and following pages*

Offenbach, 2010-03-05

(letzte Änderung/updated 2017-12-13 )

VDE Prüf- und Zertifizierungsinstitut GmbH  
VDE Testing and Certification Institute  
Zertifizierungsstelle / Certification

G. Heine

VDE Zertifikate sind nur gültig bei Veröffentlichung unter:  
VDE certificates are valid only when published on:

<http://www.vde.com/zertifikat>  
<http://www.vde.com/certificate>

Name und Sitz des Genehmigungs-Inhabers / *Name and registered seat of the Certificate holder*

Yung-Li Co. Ltd., Da Pu Industrial Zone, Cang Zi, Chang Ping Town, 523571 DONG GUAN CITY, Guangdong, CHINA

Aktenzeichen / *File ref.*

1609800-1550-0003 / 232784 / TL3 / E

letzte Änderung / *updated*

2017-12-13

Datum / *Date*

2010-03-05

Dieses Blatt gilt nur in Verbindung mit Blatt 1 des Zeichengenehmigungsausweises Nr. 40029577.

*This supplement is only valid in conjunction with page 1 of the Certificate No. 40029577.*

## Gerätesteckdose, nicht-wiederanschließbar *Connector, non-rewirable*

Typ(en) / *Type(s)*

- 1) YC-12
- 2) YC-12L

Bemessungsspannung  
*Rated voltage*

AC 250 V

Bemessungsstrom  
*Rated current*

10 A

Polzahl  
*Number of poles*

2-polig mit Schutzkontakt  
*2-pole with earthing contact*

Bauart  
*Kind of construction*

Normblatt C13  
*standard sheet C13*

Ausführung(en)  
*Construction(s)*

zentrale Leitungseinführung  
*straight cable entry*  
Für / *for* 1)

abgewinkelte Leitungseinführung  
*angled cable entry*  
Für / *for* 2)

Warenzeicheninhaber  
*Trademark holder*

Yung Li Co. Ltd.

Produktinformation

siehe Anlage Nr. 300 + 700 + 702 + 703 + 900 vom 2017-11-02  
und  
Anlage Nr. 701 vom 2017-12-13

*Product information*

*see Appendix No. 300 + 700 + 702 + 703 + 900 dated  
2017-11-02  
and  
Appendix No. 701 dated 2017-12-13*

Fortsetzung siehe Blatt 3 /  
*continued on page 3*

# VDE Prüf- und Zertifizierungsinstitut Zeichengenehmigung

Ausweis-Nr. / Blatt /  
Certificate No. / Page  
40029577 3

Name und Sitz des Genehmigungs-Inhabers / *Name and registered seat of the Certificate holder*

Yung-Li Co. Ltd., Da Pu Industrial Zone, Cang Zi, Chang Ping Town, 523571 DONG GUAN CITY, Guangdong, CHINA

Aktenzeichen / *File ref.*

1609800-1550-0003 / 232784 / TL3 / E

letzte Änderung / *updated*

2017-12-13

Datum / *Date*

2010-03-05

Dieses Blatt gilt nur in Verbindung mit Blatt 1 des Zeichengenehmigungsausweises Nr. 40029577.

*This supplement is only valid in conjunction with page 1 of the Certificate No. 40029577.*

Dieser Zeichengenehmigungs-Ausweis bildet eine Grundlage für die EG-Konformitätserklärung und CE-Kennzeichnung durch den Hersteller oder dessen Bevollmächtigten und bescheinigt die Konformität mit den grundlegenden Schutzanforderungen der **EG-Niederspannungsrichtlinie 2014/35/EU**.

*This Marks Approval is a basis for the EC Declaration of Conformity and the CE Marking by the manufacturer or his agent and proves the conformity with the essential safety requirements of the **EC Low-Voltage Directive 2014/35/EU**.*

VDE Prüf- und Zertifizierungsinstitut GmbH

*VDE Testing and Certification Institute*

Fachgebiet TL3

*Section TL3*

# VDE Prüf- und Zertifizierungsinstitut Zeichengenehmigung

Ausweis-Nr. / Beiblatt /  
Certificate No. Supplement  
40029577

Name und Sitz des Genehmigungs-Inhabers / *Name and registered seat of the Certificate holder*

Yung-Li Co. Ltd., Da Pu Industrial Zone, Cang Zi, Chang Ping Town, 523571 DONG GUAN CITY, Guangdong, CHINA

Aktenzeichen / *File ref.*

1609800-1550-0003 / 232784 / TL3 / E

letzte Änderung / *updated*

2017-12-13

Datum / *Date*

2010-03-05

Dieses Beiblatt ist Bestandteil des Zeichengenehmigungsausweises Nr. 40029577.

*This supplement is part of the Certificate No. 40029577.*

## Gerätesteckdose, nicht-wiederanschließbar *Connector, non-rewirable*

### Fertigungsstätte(n)

### *Place(s) of manufacture*

Referenz/*Reference*  
**30008928**

Yung-Li Co. Ltd.  
Da Pu Industrial Zone, Cang Zi  
Chang Ping Town  
523571 DONG GUAN CITY  
Guangdong  
CHINA

VDE Prüf- und Zertifizierungsinstitut GmbH  
*VDE Testing and Certification Institute*  
Fachgebiet TL3  
*Section TL3*





Name und Sitz des Genehmigungs-Inhabers / Name and registered seat of the Certificate holder

Yung-Li Co. Ltd., Da Pu Industrial Zone, Cang Zi, Chang Ping Town, 523571 DONG GUAN CITY, Guangdong, CHINA

Aktenzeichen / File ref.

1609800-1550-0003 / 232784 / TL3 / E

letzte Änderung / updated

2017-12-13

Datum / Date

2010-03-05

Dieses Blatt gilt nur in Verbindung mit Blatt 1 des Zeichengenehmigungsausweises Nr. 40029577.

*This supplement is only valid in conjunction with page 1 of the Certificate No. 40029577.*

## **Genehmigung zum Benutzen des auf Seite 1 abgebildeten markenrechtlich geschützten Zeichens des VDE:**

Grundlage für die Benutzung sind die Allgemeinen Geschäftsbedingungen (AGB) der VDE Prüf- und Zertifizierungsinstitut GmbH ([www.vde.com\AGB-Institut](http://www.vde.com\AGB-Institut)). Das Recht zur Benutzung erstreckt sich nur auf die bezeichnete Firma mit den genannten Fertigungsstätten und die oben aufgeführten Produkte mit den zugeordneten Bezeichnungen. Die Fertigungsstätte muss so eingerichtet sein, dass eine gleichmäßige Herstellung der geprüften und zertifizierten Ausführung gewährleistet ist.

Die Genehmigung ist so lange gültig wie die VDE-Bestimmungen gelten, die der Zertifizierung zugrunde gelegen haben, sofern sie nicht auf Grund anderer Bedingungen aus der VDE Prüf- und Zertifizierungsordnung (PM102) zurückgezogen werden muss.

Der Gültigkeitszeitraum einer VDE-GS-Zeichengenehmigung kann auf Antrag verlängert werden. Bei gesetzlichen und / oder normativen Änderungen kann die VDE-GS-Zeichengenehmigung ihre Gültigkeit zu einem früheren als dem angegebenen Datum verlieren.

Produkte, die das Biozid Dimethylfumarat (DMF) enthalten, dürfen gemäß der Kommissionsentscheidung 2009/251/EG nicht mehr in den Verkehr gebracht oder auf dem Markt bereitgestellt werden.

Der VDE-Zeichengenehmigungsausweis wird ausschließlich auf der ersten Seite unterzeichnet.

### **Approval to use the legally protected Mark of the VDE as shown on the first page:**

*Basis for the use are the general terms and conditions of the VDE Testing and Certification Institute ([www.vde.com\terms-institute](http://www.vde.com\terms-institute)). The right to use the mark is granted only to the mentioned company with the named places of manufacture and the listed products with the related type references. The place of manufacture shall be equipped in a way that a constant manufacturing of the certified construction is assured.*

*The approval is valid as long as the VDE specifications are in force, on which the certification is based on, unless it is withdrawn according to the VDE Testing and Certification Procedure (PM102E).*

*The validity period of a VDE-GS-Mark Approval may be prolonged on request. In case of changes in legal and / or normative requirements, the validity period of a VDE-GS-Mark Approval may be shortened.*

*Products containing the biocide dimethylfumarate (DMF) may not be marketed or made available on the EC market according to the Commission Decision 2009/251/EC.*

*The approval is solely signed on the first page.*

Certificate Number: 22012

# CERTIFICATE OF APPROVAL

ISSUED PURSUANT TO THE ELECTRICITY (CONSUMER SAFETY) ACT 2004

**ISSUED TO:**

Yung Li Co Ltd

**CLASS OF ARTICLE:**

Appliance Connector

**DESCRIPTION OF ARTICLE:**

Appliance Connector  
(Non-rewirable, straight entry, Group 1, C13 appliance connector for cold conditions for Class I equipment integrally moulded to any <HAR> certified H05VV-F 3G1.00mm<sup>2</sup> or Australian approved three-core, 1.00mm<sup>2</sup>, PVC insulated and sheathed ordinary duty circular flexible cord)  
250V, ac, 10A

**EXAMINED FOR COMPLIANCE WITH:** AS/NZS 60320.1 : 2004

**TYPE REFERENCE CODE:** Type No. YC-12

**APPROVAL MARK:**

Each electrical article of the abovementioned type shall be marked with Approval Number NSW22012 or N14877 ;or  
the Regulatory Compliance Mark (RCM) provided that the requirements of all relevant parts of AS/NZS 4417 applicable to the article are fulfilled.

**DATE OF APPROVAL:** 31 October 2006

This approval expires 31 October 2011 unless suspended, cancelled, renewed or extended.



for Commissioner for Fair Trading

Ref: 22012/1

## ADDENDUM TO CERTIFICATE OF APPROVAL 22012

## Particulars of Modification(s)

1. Type No. YC-12 alternatively moulded to any <HAR> certified H05VV-F 3G0.75mm<sup>2</sup> or Australian approved, three-core, 0.75mm<sup>2</sup>, PVC insulated and sheathed ordinary duty circular flexible cord not exceeding two metres in length.
  
2. Type No. YP-32 being similar to original Type No. YC-12 except a Standard Sheet 'E' Interconnection Plug Connector (AS/NZS 60320.2.2) alternatively moulded to either:-
  - (a) Any <HAR> certified H05VV-F 3G1.00mm<sup>2</sup> or equivalent Australian approved flexible cord; or
  - (b) Any <HAR> certified H05VV-F 3G0.75mm<sup>2</sup> or equivalent Australian approved flexible cord not exceeding two metres in length.
  
3. Type No. YC-12 alternatively moulded to any <HAR> certified H05VV-F 3G1.5mm<sup>2</sup> or Australian approved three-core, 1.5mm<sup>2</sup>, PVC insulated and sheathed ordinary duty circular flexible cord.

Approved: 31 October 2006



for Commissioner for Fair Trading



Fair  
Trading

Ref: NSW22012/2

RENEWAL OF CERTIFICATE OF APPROVAL NSW22012

PARTICULARS OF RENEWAL

The approval of the original appliance connector Model YC-12 and approved modifications has been renewed.

The Approval expires on 31/10/2016 unless it is renewed, extended, suspended or cancelled.

A handwritten signature in black ink, appearing to be "D. J. ...".

For Commissioner for Fair Trading



Fair  
Trading

Ref: NSW22012/3

## RENEWAL OF CERTIFICATE OF APPROVAL: NSW22012

### Particulars of Renewal

The approval of the original appliance connector Model YC-12 and approved modifications has been renewed for FIVE years.

The Approval expires on 31/10/2021 unless it is renewed, extended, suspended or cancelled.

For Commissioner for Fair Trading

## ZEICHENGENEHMIGUNG MARKS APPROVAL

Yung-Li Co. Ltd.  
Da Pu Industrial Zone, Cang Zi  
Chang Ping Town  
523571 DONG GUAN CITY  
Guangdong  
CHINA

ist berechtigt, für ihr Produkt /  
*is authorized to use for their product*

**Starkstromleitungen für allgemeine Anwendungen**  
**- Flexible Leitungen**  
**mit thermoplastischer PVC-Isolierung**  
***Cables for general applications***  
***- Flexible cables with***  
***thermoplastic PVC insulation***

die hier abgebildeten markenrechtlich geschützten Zeichen  
für die ab Blatt 2 aufgeführten Typen zu benutzen /  
*the legally protected Marks as shown below for the types referred to on page 2 ff.*

◁VDE▷ oder/or ◁▷⊠▷ oder/or  schwarz  
black rot  
red

Geprüft und zertifiziert nach /  
*Tested and certified according to*

DIN EN 50525-2-11 (VDE 0285-525-2-11):2012-01; EN 50525-2-11:2011



Aktenzeichen: 1609800-5140-0005 / 211124

File ref.:

Ausweis-Nr. 40010145

Blatt 1

Certificate No.

Page

Weitere Bedingungen siehe Rückseite und Folgeblätter /  
*further conditions see overleaf and following pages*

Offenbach, 2004-04-27

(letzte Änderung / updated 2015-05-26 )

VDE Prüf- und Zertifizierungsinstitut GmbH  
VDE Testing and Certification Institute  
Zertifizierungsstelle / Certification

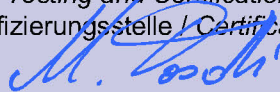

M. Tasotti

VDE Zertifikate sind nur gültig bei Veröffentlichung unter:  
VDE certificates are valid only when published on:

<http://www.vde.com/zertifikat>  
<http://www.vde.com/certificate>

Name und Sitz des Genehmigungs-Inhabers / *Name and registered seat of the Certificate holder*

Yung-Li Co. Ltd., Da Pu Industrial Zone, Cang Zi, Chang Ping Town, 523571 DONG GUAN CITY, Guangdong, CHINA

Aktenzeichen / *File ref.*

1609800-5140-0005 / 211124 / CC5 / HEG

letzte Änderung / *updated*

2015-05-26

Datum / *Date*

2004-04-27

Dieses Blatt gilt nur in Verbindung mit Blatt 1 des Zeichengenehmigungsausweises Nr. 40010145.

*This supplement is only valid in conjunction with page 1 of the Certificate No. 40010145.*

## Starkstromleitungen für allgemeine Anwendungen - Flexible Leitungen mit thermoplastischer PVC-Isolierung *Cables for general applications - Flexible cables with thermoplastic PVC insulation*

Typ(en) / *Type(s)*

H03VV-F 2...4 x 0,5...0,75 mm <sup>2</sup>	+
H03VVH2-F 2 x 0,5...0,75 mm <sup>2</sup>	+
H05VV-F 2...5 x 0,75...4 mm <sup>2</sup>	+
H05VVH2-F 2 x 0,75...1,0 mm <sup>2</sup>	+

Leitungsbauart  
*Type of cable*

Standardleitungen  
*General purpose cables*

Firmenzeichen  
*Trademark*

Yung Li Co., Ltd.

Dieser Zeichengenehmigungs-Ausweis bildet eine Grundlage für die EG-Konformitätserklärung und CE-Kennzeichnung durch den Hersteller oder dessen Bevollmächtigten und bescheinigt die Konformität mit den grundlegenden Schutzanforderungen der **EG-Niederspannungsrichtlinie 2006/95/EG** mit ihren Änderungen.

*This Marks Approval is a basis for the EC Declaration of Conformity and the CE Marking by the manufacturer or his agent and proves the conformity with the essential safety requirements of the **EC Low-Voltage Directive 2006/95/EC** including amendments.*

VDE Prüf- und Zertifizierungsinstitut GmbH  
*VDE Testing and Certification Institute*  
Fachgebiet CC5  
*Section CC5*

# VDE Prüf- und Zertifizierungsinstitut Zeichengenehmigung

Ausweis-Nr. / Beiblatt /  
Certificate No. Supplement  
40010145

Name und Sitz des Genehmigungs-Inhabers / *Name and registered seat of the Certificate holder*

Yung-Li Co. Ltd., Da Pu Industrial Zone, Cang Zi, Chang Ping Town, 523571 DONG GUAN CITY, Guangdong, CHINA

Aktenzeichen / *File ref.*

1609800-5140-0005 / 211124 / CC5 / HEG

letzte Änderung / *updated*

2015-05-26

Datum / *Date*

2004-04-27

Dieses Beiblatt ist Bestandteil des Zeichengenehmigungsausweises Nr. 40010145.

*This supplement is part of the Certificate No. 40010145.*

## **Starkstromleitungen für allgemeine Anwendungen - Flexible Leitungen mit thermoplastischer PVC-Isolierung *Cables for general applications - Flexible cables with thermoplastic PVC insulation***

**Fertigungsstätte(n)**

***Place(s) of manufacture***

Referenz/*Reference*  
**30008928**

Yung-Li Co. Ltd.  
Da Pu Industrial Zone, Cang Zi  
Chang Ping Town  
523571 DONG GUAN CITY  
Guangdong  
CHINA

VDE Prüf- und Zertifizierungsinstitut GmbH  
*VDE Testing and Certification Institute*  
Fachgebiet CC5  
*Section CC5*



Name und Sitz des Genehmigungs-Inhabers / *Name and registered seat of the Certificate holder*

Yung-Li Co. Ltd., Da Pu Industrial Zone, Cang Zi, Chang Ping Town, 523571 DONG GUAN CITY, Guangdong, CHINA

Aktenzeichen / *File ref.*

1609800-5140-0005 / 211124 / CC5 / HEG

letzte Änderung / *updated*

2015-05-26

Datum / *Date*

2004-04-27

Dieses Blatt gilt nur in Verbindung mit Blatt 1 des Zeichengenehmigungsausweises Nr. 40010145.

*This supplement is only valid in conjunction with page 1 of the Certificate No. 40010145.*

## **Genehmigung zum Benutzen des auf Seite 1 abgebildeten markenrechtlich geschützten Zeichens des VDE:**

Grundlage für die Benutzung sind die Allgemeinen Geschäftsbedingungen (AGB) der VDE Prüf- und Zertifizierungsinstitut GmbH ([www.vde.com\AGB-Institut](http://www.vde.com\AGB-Institut)). Das Recht zur Benutzung erstreckt sich nur auf die bezeichnete Firma mit den genannten Fertigungsstätten und die oben aufgeführten Produkte mit den zugeordneten Bezeichnungen. Die Fertigungsstätte muss so eingerichtet sein, dass eine gleichmäßige Herstellung der geprüften und zertifizierten Ausführung gewährleistet ist.

Die Genehmigung ist so lange gültig wie die VDE-Bestimmungen gelten, die der Zertifizierung zugrunde gelegen haben, sofern sie nicht auf Grund anderer Bedingungen aus der VDE Prüf- und Zertifizierungsordnung (PM102) zurückgezogen werden muss.

Der Gültigkeitszeitraum einer VDE-GS-Zeichengenehmigung kann auf Antrag verlängert werden. Bei gesetzlichen und / oder normativen Änderungen kann die VDE-GS-Zeichengenehmigung ihre Gültigkeit zu einem früheren als dem angegebenen Datum verlieren.

Produkte, die das Biozid Dimethylfumarat (DMF) enthalten, dürfen gemäß der Kommissionsentscheidung 2009/251/EG nicht mehr in den Verkehr gebracht oder auf dem Markt bereitgestellt werden.

Der VDE-Zeichengenehmigungsausweis wird ausschließlich auf der ersten Seite unterzeichnet.

### **Approval to use the legally protected Mark of the VDE as shown on the first page:**

*Basis for the use are the general terms and conditions of the VDE Testing and Certification Institute ([www.vde.com\terms-institute](http://www.vde.com\terms-institute)). The right to use the mark is granted only to the mentioned company with the named places of manufacture and the listed products with the related type references. The place of manufacture shall be equipped in a way that a constant manufacturing of the certified construction is assured.*

*The approval is valid as long as the VDE specifications are in force, on which the certification is based on, unless it is withdrawn according to the VDE Testing and Certification Procedure (PM102E).*

*The validity period of a VDE-GS-Mark Approval may be prolonged on request. In case of changes in legal and / or normative requirements, the validity period of a VDE-GS-Mark Approval may be shortened.*

*Products containing the biocide dimethylfumarate (DMF) may not be marketed or made available on the EC market according to the Commission Decision 2009/251/EC.*

*The approval is solely signed on the first page.*