

東莞永力電業有限公司

YUNG LI CO., LTD

Da Pu Industrial Zone, Gang Zi, Changping Town,
Dong Guan City, Guangdong 523571 China.P.R.C

TEL:0769-83396797~8

FAX:0769-83396796

E-mail: sales@yung-li.com

Description: YP-CHYC-1J

Customer: _SY

Parts No. :

Draw No. :

REVISION RECORD

| | | |
|---|--|--|
| 1 | | |
| 2 | | |
| 3 | | |
| 4 | | |
| 5 | | |

| YUNG LI | |
|---------|-------------|
| CHECKED | PREPARED BY |
| | |

| CUSTOMER | APPROVED |
|----------|----------|
| | |

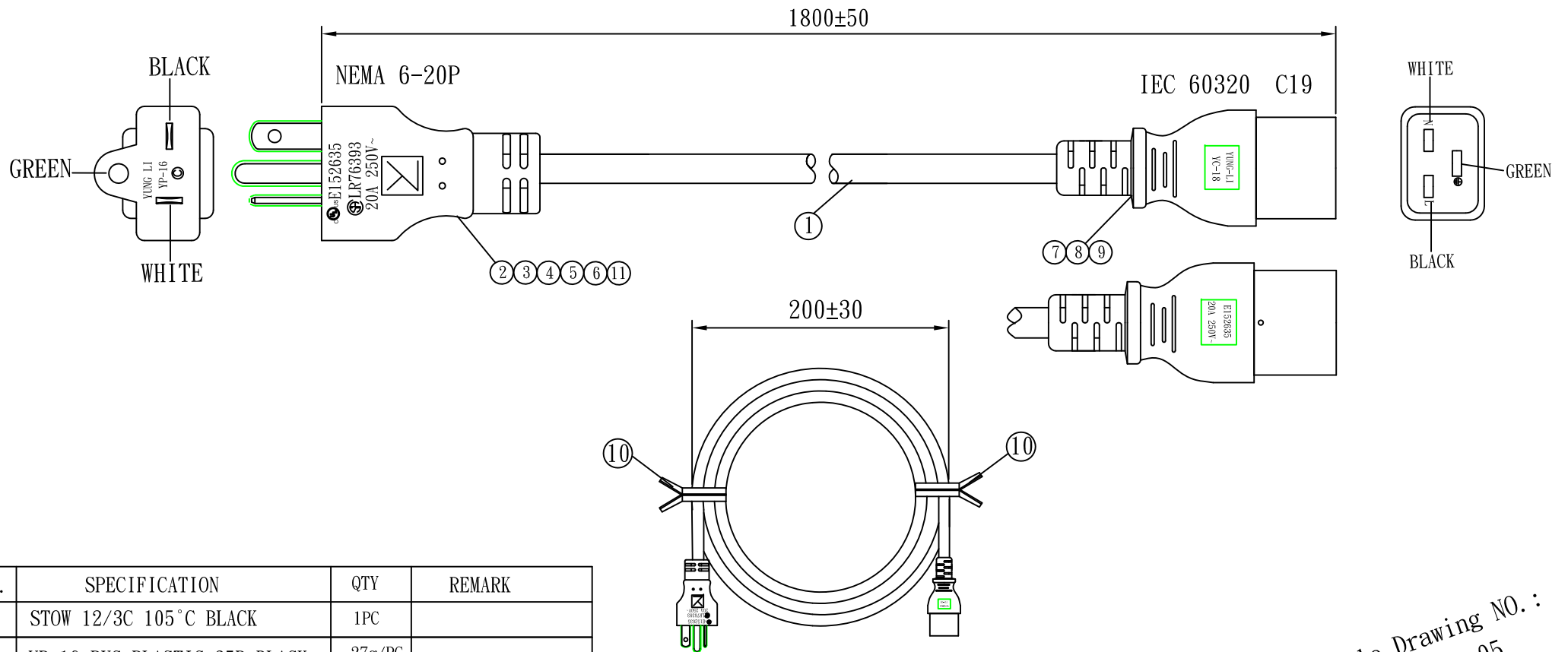

| NO. | SPECIFICATION | QTY | REMARK |
|-----|-----------------------------|--------|--------|
| 1 | STOW 12/3C 105°C BLACK | 1PC | |
| 2 | YP-16 PVC PLASTIC:35P BLACK | 27g/PC | |
| 3 | TER: 98695BS-1 | 2PCS | |
| 4 | TER:98473 | 1PC | |
| 5 | YP-16 INNER BODY | 1PC | |
| 6 | SLEEVE WHITE | 1PC | |
| 7 | YC-18 PVC PLASTIC:50P BLACK | 25g/PC | |
| 8 | YC-18 INNER BODY | 1PC | |
| 9 | YC-18 TER | 3PCS | |
| 10 | MINI TIE BLACK | 2PCS | |
| 11 | RING: ϕ 16*2.0mm | 1PC | |

| | | | | | | | | |
|--|-------------|-------------|------|----------|------------------------|---------|------|----|
| TOLERANCE $>0\pm 0.30$ $>1.0\pm 0.50$ $>10.0\pm 1.0$ $>20.0\pm 2.0$ Angle: $\pm 1^\circ$ | APPROVED | | DATE | | YUNG LI CO.,LTD | | | |
| | CHECKED | | DATE | | | | | |
| | DRAWN | SUKI | DATE | 21.02.18 | CUSTOMER | MAG | | |
| | TYPE | YP-16/YC-18 | | | P/N | | | |
| | DRAWING NO. | | REV | B | MATERIAL | P. V. C | UNIT | mm |
| | | | | SCALE | | | | |

Sample Drawing NO. :
SP210218-05



NEMA 6-20P

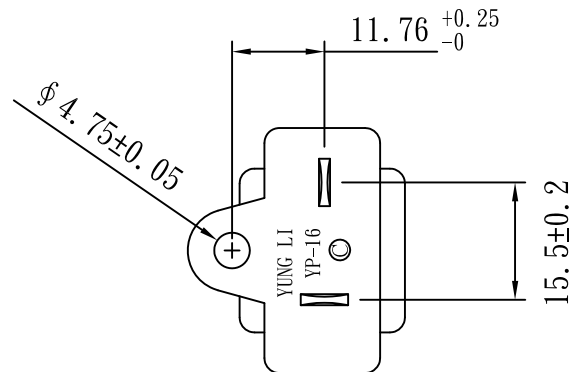
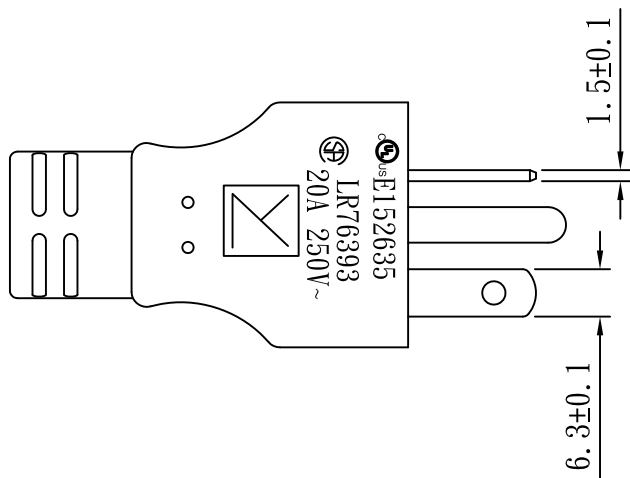
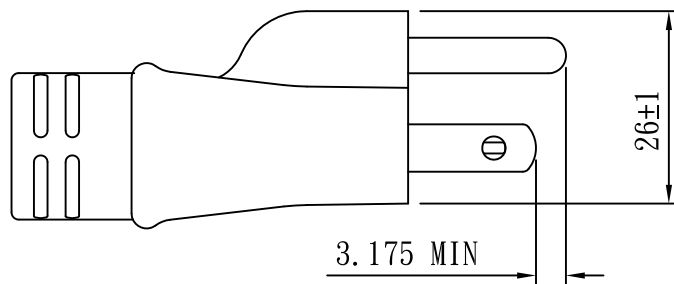
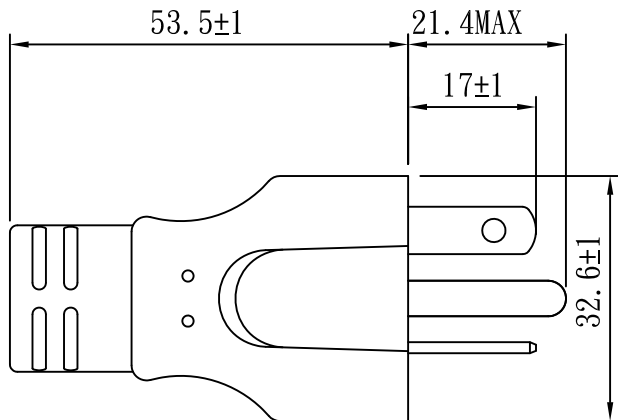

| | | | | | | | |
|--|-----|-------|--------------------------------------|----------|-------|----|----|
| 核准: | 審核: | 業務: | 東莞永力電業有限公司 YUNG LI CO.,LTD | | | | |
| 一般寸法公差: >0±0.30 >1.0±0.50 >10.0±1.0 >20.0±2.0 Angle:±1° | 制圖 | 周淑萍 | 日期 | 20.09.21 | 客戶 | | |
| | 型號 | YP-16 | | 版本 | B | 單重 | |
| | 圖號 | | | 材質 | P.V.C | 單位 | mm |
| | | | | 比例 | 1:1 | | |

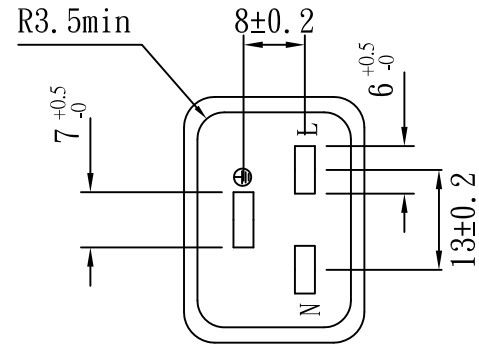
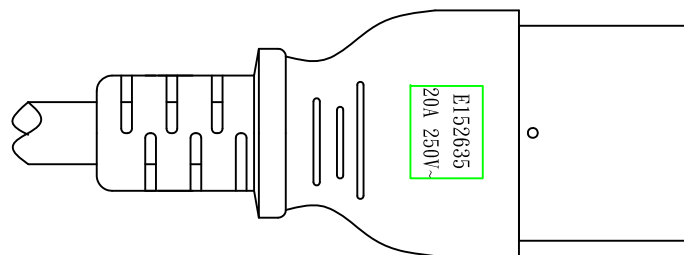
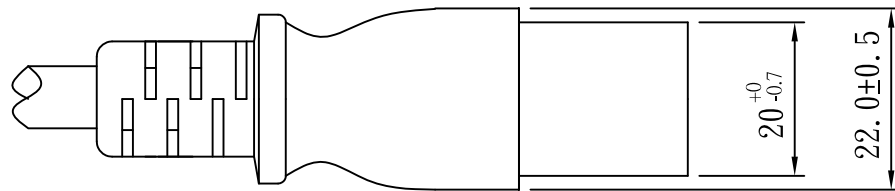
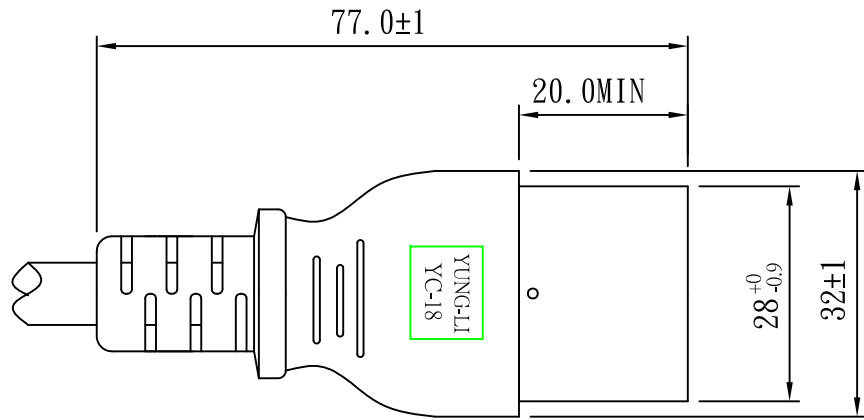

| | | | | | | | | |
|--|-------------|----------------|------|------------------|----------|---------|------|----|
| TOLERANCE >0±0.30 >1.0±0.50 >10.0±1.0 >20.0±2.0 Angle: ±1° | APPROVED | | DATE | YUNG LI CO., LTD | | | | |
| | CHECKED | | DATE | | | | | |
| | DRAWN | | DATE | CUSTOMER | | | | |
| | TYPE | YC-18 | | | P/N | | | |
| | DRAWING NO. | CY-C18U20A250V | | | MATERIAL | P. V. C | UNIT | mm |
| | | | | SCALE | 1:1 | | | |

YUNG LI CO., LTD

SPECIFICATION

| | | | |
|-----------|-------|-------------------------|-------------|
| Yung-Li | Style | PVC FLEXIBLE CORDS | Document No |
| 2008.9.25 | | | |
| Edition | Size | STOW 12/3C 105°C | Page |
| A | | | 1/2 |

1. Standard : UL 62 UL 1581

2. Construction & Dimension

| | Item | Specification |
|---------------|--------------------------------|------------------------------|
| Conductor | Size | 12AWG /3C |
| | Material | Annealed Bare Copper |
| | Construction | 65/ ϕ 0.254 \pm 0.005 |
| Insulation | Material | PVC |
| | Minimum Average Thickness | 1.14mm |
| | Minimum Thickness at any point | 1.02mm |
| | Diameter | 4.75 \pm 0.1 |
| | Identification | Black White Green |
| Core Assembly | Core Twist | 3-Core |
| | Filler | COTTON 18000D |
| | Assembly Pair | NA |
| Taping | Mylar Foil | NA |
| Shielded | A1-Mylar Foil | NA |
| Drain Wire | Material | NA |
| | Construction | NA |
| Jacket | Material | PVC |
| | Minimum Average Thickness | 2.41mm |
| | Minimum Thickness at any point | 1.93mm |
| | Overall Diameter(Approx) | 15.3 \pm 0.2 |
| | Color | Any Color |

Marking :

YUNG LI (UL) E241374 STOW 3/C 12AWG(3.31mm²) 105°C 600V VW-1
CSA 177323 STOW 3/C 12AWG(3.31mm²) 105°C 600V FT2

YUNG LI CO., LTD

SPECIFICATION

| | | | |
|-----------|-------|-------------------------|-------------|
| Yung-Li | Style | PVC FLEXIBLE CORDS | Document No |
| 2008.9.25 | | | |
| Edition | Size | STOW 12/3C 105°C | Page |
| A | | | 2/2 |

3. Electrical & Physical Properties

| Item | | Specification | |
|-----------------------|---------------|--|--------------------------|
| Rating Voltage | | 600V | |
| Insulation Resistance | | $\geq 0.76\text{M}\Omega/\text{Km}$ 15°C Min | |
| Dielectric Strength | | AC 3.0KV/1 min No Crack | |
| Spark Test | | 7.5KV/0.15 Sec | |
| Insulation | Unaged | Tensile Strength | 1500 lbs/in2 min |
| | | Elongation | 100%Min |
| | Aged | Tensile Strength | Min 85%(136±1°C x168hrs) |
| | | Elongation | Min 65%(136±1°C x168hrs) |
| Jacket | Unaged | Tensile Strength | 1500 lbs/in2 min |
| | | Elongation | 100%Min |
| | Aged | Tensile Strength | Min 85%(136±1°C x168hrs) |
| | | Elongation | Min 45%(136±1°C x168hrs) |
| | Oil immersion | Tensile Strength | Min 75%(60±2°C x168hrs) |
| | | Elongation | Min 75%(60±2°C x168hrs) |
| Deformation Test | | 121±1°C x 1hr \leq 50% | |
| Cold Bend Test | | -40±1°C x 4hr No Crack | |
| Heat Shock Test | | 121±1°C x 4hr No Crack | |

Graph:

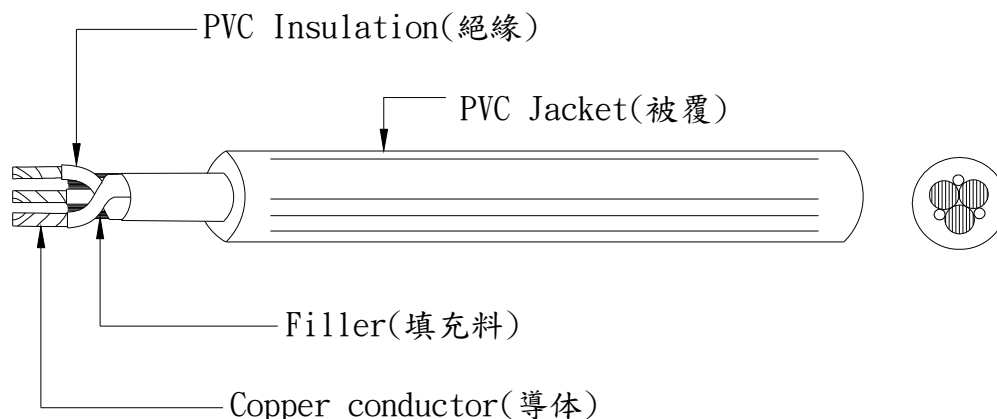



ELBZ7.E152635 - Cord Sets and Power-supply Cords Certified for Canada

Cord Sets and Power-supply Cords Certified for Canada

See General Information for Cord Sets and Power-supply Cords Certified for Canada

YUNG LI CO LTD

E152635

7F-12 NO 99 SEC 1 XINTAI 5TH RD
XIZHI DISTRICT
NEW TAIPEI, 22175 TAIWAN

Power-supply cords

| Cat. No. | ANSI/NEMA Cord WD6 Config AWG | Cord Type | Electrical Rating Amps V |
|----------|----------------------------------|--|--------------------------------|
| YP-11 | 1-15 | 18/2 SPT-1, SPT-2, SPT-3, NISPT-2, SVT, SVTO, SJT, SJTW, SJTO, SJTOW (All TPE material), SPT-1, SPT-1W, NISPT-1, SPT-2, SPT-2W, NISPT-2, SPT-3, HPN, SVT, SVTO, SJT, SJTW, SJTO, SJTOW, SV, SVO, SJ, SJO, SJOW, SJOOW, EVT, EVJT, EVE, EVJE | 7 or 10/125 |
| | | 17/2 SVT, SVTO (All TPE material), SVT, SVTO, SV, SVO, SJ, SJO, SJOW, SJOOW, EVT, EVJT, EVE, EVJE | 12/125 |
| | | 16/2 SPT-2, SPT-3, NISPT-2, SVT, SVTO, SJT, SJTW, SJTO, SJTOW (All TPE material), SPT-2, SPT-2W, NISPT-2, SPT-3, SVT, SVTO, SJT, SJTW, SJTO, SJTOW, SV, SVO, SJ, SJO, SJOW, SJOOW, EVT, EVJT, EVE, EVJE | 13/125 |
| | | 16/2 HPN | 15/125 |
| | | 14/2 SPT-3, SJT, SJTW, SJTO, SJTOW (All TPE material), SPT-3, SJT, SJTW, SJTO, SJTOW, SJ, SJO, SJOW, SJOOW, EVT, EVJT, EVE, EVJE | 15/125 |
| YP-11W | 1-15P | 18/2 SPT-1, SPT-2, SPT-3, NISPT-2, SVT, SVTO, SJT, SJTW, SJTO, SJTOW (All TPE material), SPT-1, SPT-1W, NISPT-1, SPT-2, SPT-2W, NISPT-2, SPT-3, HPN, SVT, SVTO, SJT, SJTW, , SJTO, SJTOW, SV, SVO, SJ, SJO, SJOW, SJOOW, EVT, EVJT, EVE, EVJE | 7 or 10/125 |
| | | 17/2 SVT, SVTO (All TPE material), SVT, SVTO, SV, SVO, SJ, SJO, SJOW, SJOOW, EVT, EVJT, EVE, EVJE | 12/125 |
| | | 16/2 SPT-2, SPT-3, NISPT-2, SVT, SVTO, SJT, SJTW, SJTO, SJTOW (All TPE material), SPT-2, SPT-2W, NISPT-2, SPT-3,SVT, SVTO, SJT, SJTW, SJTO, SJTOW, SV, SVO, SJ, SJO, SJOW, SJOOW, EVT, EVJT, EVE, EVJE | 13/125 |
| | | 16/2 HPN | 15/125 |
| | | 14/2 SPT-3, SJT, SJTW, SJTO, SJTOW (All TPE material), SPT-3, SJT, SJTW, SJTO, SJTOW, SJ, SJO, SJOW, SJOOW, EVT, EVJT, EVE, EVJE | 15/125 |

| | | | | |
|---------------|------|------|---|---------------|
| | | 12/3 | SJT, SJTW, SJTO, SJTOW, ST, STW, STOW (All TPE material), SJT, SJTW, SJTO, SJTOW, ST, STW, STOW, SO, SOW, SOOW, EVT, EVJT, EVE, EVJE | 15/125 |
| YP-12L(A.C.1) | 5-15 | 18/3 | NISPT-2 (TPE), NISPT-2, EVT, EVJT, EVE, EVJE | 7 or 10/125 |
| | | 16/3 | NISPT-2 (TPE), NISPT-2, EVT, EVJT, EVE, EVJE | 13/125 |
| YP-16 | 6-20 | 18/3 | SVT, SVT Shielded, SVTO, SJT, SJT Shielded, SJTW, SJTW Shielded, SJTO, SJTOW, ST, STW, STOW, SPT-2, SPT-3 (All TPE material), SVT, SVT Shielded, SVTO, SJT, SJT Shielded, SJTW, SJTW Shielded, SJTO, SJTOW, ST, STW, STOW, SV, SVO, SJ, SJO, SJOW, SJOOW, S, SO, SOW, SOOW, SPT-2, SPT-3, EVT, EVJT, EVE, EVJE | 2.5 or 10/250 |
| | | 17/3 | SVT, SVTO (All TPE material), SVT, SVTO, SV, SVO, EVT, EVJT | 12/250 |
| | | 16/3 | SVT, SVTO, SJT, SJTW, SJTO, SJTOW, ST, STW, STOW, SPT-2, SPT-3 (All TPE material), SVT, SVTO, SJT, SJTW, SJTO, SJTOW, ST, STW, STOW, SV, SVO, SJ, SJO, SJOW, SJOOW, S, SO, SOW, SOOW, SPT-2, SPT-3, EVT, EVJT, EVE, EVJE | 13/250 |
| | | 14/3 | SJT, SJTW, SJTO, SJTOW, ST, STW, STOW, SPT-3 (All TPE material), SJT, SJTW, SJTO, SJTOW, ST, STW, STOW, SJ, SJO, SJOW, SJOOW, S, SO, SOW, SOOW, SPT-3, EVT, EVJT, EVE, EVJE | 18/250 |
| | | 12/3 | SJT, SJTW, SJTO, SJTOW, ST, STW, STOW, SPT-3 (All TPE material), SJT, SJTW, SJTO, SJTOW, ST, STW, STOW, SJ, SJO, SJOW, SJOOW, S, SO, SOW, SOOW, SPT-3, EVT, EVJT, EVE, EVJE | 20/250 |
| YP-16L | 6-20 | 18/3 | SJT, SJTW, SJTO, SJTOW, ST, STW, STOW (All TPE material), SJT, SJTW, SJTO, SJTOW, ST, STW, STOW, SO, SOW, SOOW, EVT, EVJT, EVE, EVJE | 2.5 or 10/250 |
| | | 16/3 | SJT, SJTW, SJTO, SJTOW, ST, STW, STOW (All TPE material), SJT, SJTW, SJTO, SJTOW, ST, STW, STOW, SO, SOW, SOOW, EVT, EVJT, EVE, EVJE | 13/250 |
| | | 14/3 | SJT, SJTW, SJTO, SJTOW, ST, STW, STOW, SPT-3 (All TPE material), SJT, SJTW, SJTO, SJTOW, ST, STW, STOW, SO, SOW, SOOW, SPT-3, EVT, EVJT, EVE, EVJE | 18/250 |
| | | 12/3 | SJT, SJTW, SJTO, SJTOW, ST, STW, STOW, SPT-3 (All TPE material), SJT, SJTW, SJTO, SJTOW, ST, STW, STOW, SO, SOW, SOOW, SPT-3, EVT, EVJT, EVE, EVJE | 20/250 |
| YP-17 | 5-20 | 18/3 | SVT, SVT Shielded, SVTO, SJT, SJT Shielded, SJTW, SJTW Shielded, SJTO, SJTOW, ST, STW, STOW, SPT-2, SPT-3 (All TPE material), SVT, SVT Shielded, SVTO, SJT, SJT Shielded, SJTW, SJTW Shielded, SJTO, SJTOW, ST, STW, STOW, SV, SVO, SJ, SJO, SJOW, SJOOW, S, SO, SOW, SOOW, SPT-2, SPT-3, EVT, EVJT, EVE, EVJE | 7 or 10/125 |
| | | 17/3 | SVT, SVTO (All TPE material), SVT, SVTO, SV, SVO, EVT, EVJT, EVE, EVJE | 12/125 |
| | | 16/3 | SVT, SVTO, SJT, SJTW, SJTO, SJTOW, ST, STW, STOW, SPT-2, SPT-3 (All TPE material), SVT, SVTO, SJT, SJTW, SJTO, SJTOW, ST, STW, STOW, SV, SVO, SJ, SJO, SJOW, SJOOW, S, SO, SOW, SOOW, SPT-2, SPT-3, EVT, EVJT, EVE, EVJE | 13/125 |

| | | | | |
|--------------------------------------|---------|----|--|-------------------------|
| | | 14 | SJT, SJTW, SJTO, SJTOW, ST, STW, STOW (Shielded and Non-shielded for all types), SPT-3 (All TPE material), SJT, SJTW, SJTO, SJTOW, ST, STW, STOW, SJ, SJO, SJOO, SJOW, SJOOW, SO, SOO, SOW, SOOW (Shielded or Non-shielded for above types), SPT-3 | 15/125 or 250 |
| | | 12 | SJT, SJTW, SJTO, SJTOW, ST, STW, STOW (All TPE material, Shielded and Non-shielded for all types), SJT, SJTW, SJTO, SJTOW, ST, STW, STOW, SJ, SJO, SJOO, SJOW, SJOOW, SO, SOO, SOW, SOOW (Shielded or Non-shielded for all types) | 15/125 or 250 |
| YC-12(A.C.1) | IEC C13 | 12 | SJT, SJTW, SJTO, SJTOW, ST, STW, STOW, SPT-3 (All TPE material), SJT, SJTW, SJTO, SJTOW, ST, STW, STOW, SO, SOW, SOOW, SPT-3 | 15/125 or 250 |
| | | 10 | SJT, SJTW, SJTO, SJTOW, ST, STW, STOW (All TPE material), SJT, SJTW, SJTO, SJTOW, ST, STW, STOW, SO, SOW, SOOW | 15/125 or 250 |
| YC-12C | IEC C13 | 18 | NISPT-2 (TPE), NISPT-2 | 2.5, 7 or 10/125 or 250 |
| | | 16 | NISPT-2 (TPE), NISPT-2 | 13/125 or 250 |
| YC-13 | IEC C7 | 18 | SPT-1, SPT-2, NISPT-2, SVT, SJT (All TPE material), SPT-1, SPT-1W, SPT-2, SPT-2W, NISPT-1, NISPT-2, SVT, SJT | 2.5/250 or 7/125 |
| YC-13W | IEC C7P | 18 | SPT-1, SPT-2, NISPT-2, SVT, SJT (All TPE material), SPT-1, SPT-1W, SPT-2, SPT-2W, NISPT-1, NISPT-2, SVT, SJT | 2.5/250 or 7/125 |
| YC-14 | IEC C5 | 18 | SPT-2, SVT, SVT shielded, SVTO, SJT, SJT shielded, SJTW, SJTW shielded, SJTO, SJTOW (All TPE material), SVT, SVT Shielded, SVTO, SJT, SJT Shielded, SJTW, SJTW Shielded, SJTO, SJTOW, SV, SVO, SJ, SJO, SJOW, SJOOW | 2.5/250 or 7/125 |
| | | | SPT-2 | |
| YC-13L | IEC C7 | 18 | SPT-1, SPT-2, NISPT-2, SVT, SJT (All TPE material), SPT-1, SPT-1W, SPT-2, SPT-2W, NISPT-1, NISPT-2, SVT, SJT | 2.5/250 or 7/125 |
| YC-13D | IEC C7 | 18 | SPT-1, SPT-2, NISPT-2, SVT, SJT (All TPE material), SPT-1, SPT-1W, SPT-2, SPT-2W, NISPT-1, NISPT-2, SJT, SVT | 2.5/250 or 7/125 |
| YC-13C | IEC C7 | 18 | NISPT-2 (All TPE material), NISPT-1, NISPT-2 | 2.5/250 or 7/125 |
| YC-13E | IEC C7 | 18 | SPT-1, SPT-2, NISPT-2, SVT, SJT (All TPE material), SPT-1, SPT-1W, SPT-2, SPT-2W, NISPT-1, NISPT-2, SVT, SJT | 2.5/250 or 7/125 |
| YC-14L, YC-14L-1, YC-14L-2, YC-14L-3 | IEC C5 | 18 | SVT, SJT, SPT-2 (All TPE material), SVT, SJT, SPT-2 | 2.5/250 or 7/125 |
| YC-18 | IEC C19 | 16 | SJT, SJTW, SJTO, SJTOW, SJTOOW, ST, STW, STOW, STOOW, SPT-3 (All TPE material), SJT, SJTW, SJTO, SJTOW, SJTOOW, SJ, SJO, SJOO, SJOW, SJOOW, ST, STW, STOW, STOOW, S, SO, SOW, SOO, SOOW, SPT-3 | 13/125 or 250 |

| | | | | |
|--------|---------|----|--|-------------------------|
| | | 15 | SJT, SJTW, SJTO, SJTOW, SJTOOW, ST, STW, STOW, STOOW, SPT-3 (All TPE material), SJT, SJTW, SJTO, SJTOW, SJTOOW, SJ, SJO, SJOO, SJOW, SJOOW, ST, STW, STOW, STOOW, S, SO, SOW, SOO, SOOW, SPT-3 | 16/125 or 250 |
| | | 14 | SJT, SJTW, SJTO, SJTOW, SJTOOW, ST, STW, STOW, STOOW, SPT-3 (All TPE material), SJT, SJTW, SJTO, SJTOW, SJTOOW, SJ, SJO, SJOO, SJOW, SJOOW, ST, STW, STOW, STOOW, S, SO, SOW, SOO, SOOW, SPT-3 | 16/125 or 250 |
| | | 12 | SJT, SJTW, SJTO, SJTOW, SJTOOW, ST, STW, STOW, STOOW, SPT-3 (All TPE material), SJT, SJTW, SJTO, SJTOW, SJTOOW, SJ, SJO, SJOO, SJOW, SJOOW, ST, STW, STOW, STOOW, S, SO, SOW, SOO, SOOW, SPT-3 | 20/125 or 250 V ac |
| YC-18L | IEC C19 | 16 | SJT, SJTW, SJTO, SJTOW, SJTOOW, ST, STW, STOW, STOOW, SPT-3 (All TPE material), SJT, SJTW, SJTO, SJTOW, SJTOOW, SJ, SJO, SJOO, SJOW, SJOOW, ST, STW, STOW, STOOW, S, SO, SOW, SOO, SOOW, SPT-3 | 13/125 or 250 V ac |
| | | 15 | SJT, SJTW, SJTO, SJTOW, SJTOOW, ST, STW, STOW, STOOW, SPT-3 (All TPE material), SJT, SJTW, SJTO, SJTOW, SJTOOW, SJ, SJO, SJOO, SJOW, SJOOW, ST, STW, STOW, STOOW, S, SO, SOW, SOO, SOOW, SPT-3 | 250 V ac |
| | | 14 | SJT, SJTW, SJTO, SJTOW, SJTOOW, ST, STW, STOW, STOOW, SPT-3 (All TPE material), SJT, SJTW, SJTO, SJTOW, SJTOOW, SJ, SJO, SJOO, SJOW, SJOOW, ST, STW, STOW, STOOW, S, SO, SOW, SOO, SOOW, SPT-3 | 16/125 or 250 V ac |
| | | 12 | SJT, SJTW, SJTO, SJTOW, SJTOOW, ST, STW, STOW, STOOW, SPT-3 (All TPE material), SJT, SJTW, SJTO, SJTOW, SJTOOW, SJ, SJO, SJOO, SJOW, SJOOW, ST, STW, STOW, STOOW, S, SO, SOW, SOO, SOOW, SPT-3 | 20/125 or 250 V ac |
| YC-20 | IEC C15 | 18 | SVT, SJT, SJTW, SJTO, SJTOW, ST, STW, STOW, SPT-3 (All TPE material), SVT, SJT, SJTW, SJTO, SJTOW, ST, STW, STOW, SO, SOW, SOOW, SPT-3 | 2.5, 7 or 10/125 or 250 |
| | | 17 | SVT, SJT, SJTW, SJTO, SJTOW, ST, STW, STOW, SPT-3 (All TPE material), SVT, SJT, SJTW, SJTO, SJTOW, ST, STW, STOW, SO, SOW, SOOW, SPT-3 | 12/125 or 250 |
| | | 16 | SJT, SJTW, SJTO, SJTOW, ST, STW, STOW, SPT-3 (All TPE material), SJT, SJTW, SJTO, SJTOW, ST, STW, STOW, SO, SOW, SOOW, SPT-3 | 13/125 or 250 |
| | | 15 | SJT, SJTW, SJTO, SJTOW, ST, STW, STOW, SPT-3 (All TPE material), SJT, SJTW, SJTO, SJTOW, ST, STW, STOW, SO, SOW, SOOW, SPT-3 | 14/125 or 250 |
| | | 14 | SJT, SJTW, SJTO, SJTOW, ST, STW, STOW, SPT-3 (All TPE material), SJT, SJTW, SJTO, SJTOW, ST, STW, STOW, SO, SOW, SOOW | 15/125 or 250 |
| YC-25 | IEC C21 | 16 | SJT, SJTW, SJTO, SJTOW, SJTOOW, ST, STW, STOW, STOOW, SPT-3 (All TPE material), SJT, SJTW, SJTO, SJTOW, SJTOOW, SJ, SJO, SJOO, SJOW, SJOOW, ST, STW, STOW, STOOW, S, SO, SOW, SOO, SOOW, SPT-3 | 13/125 or 250 |
| | | 15 | SJT, SJTW, SJTO, SJTOW, SJTOOW, ST, STW, STOW, STOOW, SPT-3 (All TPE material), SJT, SJTW, SJTO, SJTOW, SJTOOW, SJ, SJO, SJOO, SJOW, SJOOW, ST, STW, STOW, STOOW, S, SO, SOW, SOO, SOOW, SPT-3 | 16/125 or 250 |
| | | 14 | SJT, SJTW, SJTO, SJTOW, SJTOOW, ST, STW, STOW, STOOW, SPT-3 (All TPE material), SJT, SJTW, SJTO, SJTOW, SJTOOW, SJ, SJO, SJOO, SJOW, SJOOW, ST, STW, STOW, STOOW, S, SO, SOW, SOO, SOOW, SPT-3 | 16/125 or 250 |
| | | 12 | SJT, SJTW, SJTO, SJTOW, SJTOOW, ST, STW, STOW, STOOW, SPT-3 (All TPE material), SJT, SJTW, SJTO, SJTOW, SJTOOW, SJ, SJO, SJOO, SJOW, SJOOW, ST, STW, STOW, STOOW, S, SO, SOW, SOO, SOOW, SPT-3 | 20/125 or 250 |
| YC-25L | IEC C21 | 16 | SJT, SJTW, SJTO, SJTOW, SJTOOW, ST, STW, STOW, STOOW, SPT-3 (All TPE material), SJT, SJTW, SJTO, SJTOW, SJTOOW, SJ, SJO, SJOO, SJOW, SJOOW, ST, STW, STOW, STOOW, S, SO, SOW, SOO, SOOW, SPT-3 | 13/125 or 250 V ac |

Certificate of Compliance

Certificate: 1868157 (LR 76393-10)

Master Contract: 177323

Project: 70057585

Date Issued: 2016-04-20

Issued to: Yung Li Company Ltd.
1F No 10 Lane 235 Pao Chiao Rd
Hsin Tien City
Taipei Hsien,
TAIWAN

Attention: Mr. W. T. Lai

The products listed below are eligible to bear the CSA Mark shown



Vivian Zhao

Issued by: Vivian Zhao

PRODUCTS

CLASS - C584202 - CORD SETS-Power Supply Cords

Power supply cord(s) consisting of the following plug caps moulded onto flexible cords as listed:

| Cat No. | Plug Cap | | | Flexible Cord | |
|---------|-----------|---------------|------|-----------------|--|
| | Rating | Configuration | AWG | Temp(°C) | Type |
| YP-16 | 20A, 250V | 6-20P | 12/3 | 60, 75, 90, 105 | SPT-3, SJT, SJTO, SJTOW, ST, STW, STOW, SO, SOW, SOOW S, SJ, SJO, SJOW, SJOOW |
| | 18A, 250V | 6-20P | 14/3 | | |
| | 10A, 250V | 6-20P | 18/3 | | |
| YP-17 | 20A, 125V | 5-20P | 12/3 | 60, 75, 90, 105 | |
| | 18A, 125V | 5-20P | 14/3 | | |
| YP-19 | 15A, 250V | 6-15P | 12/3 | 60, 75, 90, 105 | |
| | 15A, 250V | 6-15P | 14/3 | | |

Note: These are sold to manufacturers for the assembly as components of Certified electrical equipment where the suitability of the combination is determined by CSA International.

APPLICABLE REQUIREMENTS

- CSA C22.2 No. 21 - Cord Sets and Power Supply Cords
- CSA C22.2 No. 42 - General Use Receptacles, Attachment Plugs and Similar Wiring Devices
- INFORMS Cord Sets No.7A - Production-Line Test for Cord Sets and Power-Supply Cords

Supplement to Certificate of Compliance

Certificate: 1868157(LR 76393-10)

Master Contract: 177323

*The products listed, including the latest revision described below,
are eligible to be marked in accordance with the referenced Certificate.*

Product Certification History

| Project | Date | Description |
|----------------|-------------|---|
| 70057585 | 2016-04-20 | Update report 1868157 to comply with C22.2 No.21-14. |
| 1868157 | 2007-03-19 | Power Supply Cord consisting of the attachment plug cap, Cat No YP-16, YP-17 and YP-19. (Supersedes Report LR 76393-10 and includes alternative PVC compounds.) |

**ZJCZ.E241374**
Flexible Cord[Page Bottom](#)

Flexible Cord[See General Information for Flexible Cord](#)**YUNG LI CO LTD**

E241374

7F-12 NO 99 SEC 1 XINTAI 5TH RD
XIZHI DISTRICT
NEW TAIPEI, 22175 TAIWAN**Decorative cord**, Type(s) SPT-1W, SPT-2W**Dryer and range cord**, Type(s) SRDT**Jacketed cord**, Type(s) S, SE, SE-HF, SJ, SJE, SJE-HF, SJO, SJO, SJOOW, SJOW, SJT, SJT-B, SJTO, SJTOW, SJTW, SO, SOO, SOOW, SOW, ST, ST-B, STO, STOW, STW, SVE, SVE-HF, SVT, SVT-B, SVTO**Parallel cord**, Type(s) NISPE-1, NISPE-1-HF, NISPE-2, NISPE-2-HF, NISPT-1, NISPT-2, SPE-1, SPE-1-HF, SPE-2, SPE-2-HF, SPE-3, SPE-3-HF, SPT-1, SPT-2, SPT-3[Last Updated](#) on 2016-03-07

[Questions?](#)[Print this page](#)[Terms of Use](#)[Page Top](#)

◆ 2016 UL LLC

The appearance of a company's name or product in this database does not in itself assure that products so identified have been manufactured under UL's Follow-Up Service. Only those products bearing the UL Mark should be considered to be Certified and covered under UL's Follow-Up Service. Always look for the Mark on the product.

UL permits the reproduction of the material contained in the Online Certification Directory subject to the following conditions: 1. The Guide Information, Assemblies, Constructions, Designs, Systems, and/or Certifications (files) must be presented in their entirety and in a non-misleading manner, without any manipulation of the data (or drawings). 2. The statement "Reprinted from the Online Certifications Directory with permission from UL" must appear adjacent to the extracted material. In addition, the reprinted material must include a copyright notice in the following format: "© 2016 UL LLC".



Certificate of Compliance

Certificate: 1594794 (LL 76398)

Master Contract: 177323

Project: 2616524

Date Issued: April 3, 2013

Issued to: Yung Li Company Ltd.

1F No 10 Lane 235 Pao Chiao Rd
Hsin Tien City
Taipei Hsien,
Taiwan
Attention: Wendy Wu

The products listed below are eligible to bear the CSA Mark shown



Kim Nguyen

Issued by: Kim Nguyen, P. Eng.

PRODUCTS

CLASS 5831 01 - WIRES - Flexible Cord

Types SPT-1, NISPT-1, SPT-2, NISPT-2, SPT-3, SVT, SVTO, SJT, SJTW, SJTO, SJTOW, ST, STW, STO, STOW with PVC insulation and jacket, rated 60C, 75C, 90C and 105C, FT1, FT2, VW-1.

APPLICABLE REQUIREMENTS

CSA C22.2 No 49 - Flexible Cords and Cables