

東莞永力電業有限公司

YUNG LI CO., LTD

Da Pu Industrial Zone, Gang Zi, Changping Town,
Dong Guan City, Guangdong 523571 China.P.R.C

TEL:0769-83396797~8

FAX:0769-83396796

E-mail: sales@yung-li.com

Description: YP-22/YC-12L-2

Customer: MAG

Parts No. :

Draw No. :

REVISION RECORD

1		
2		
3		
4		
5		

YUNG LI		CUSTOMER	APPROVED
CHECKED	PREPARED BY		

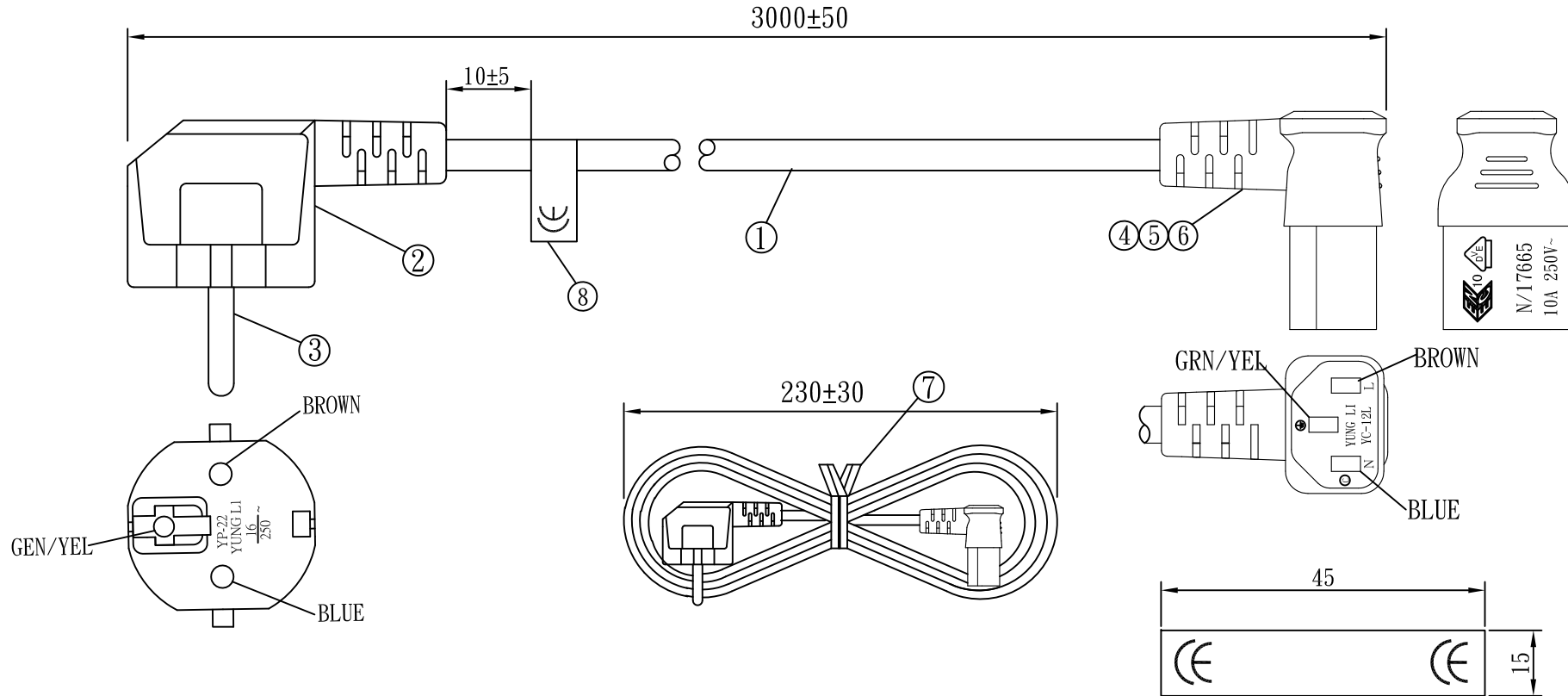

NO.	SPECIFICATION	QTY	REMARK
1	H05VV-F 1.0/3G BLACK	1PC	
2	YP-22 PVC PLASTIC:50P BLACK	34g/PC	
3	3Pin Euro plug inner model:98651 Black	1PC	
4	TER:97740	3PCS	
5	YC-12L-2 INNER BODY	1PC	
6	YC-12L-2 PVC PLASTIC:50P BLACK	18g/PC	
7	MINI TIE:L=180mm BLACK	1PC	
8	LABEL:45x15mm	1PC	Label-4144

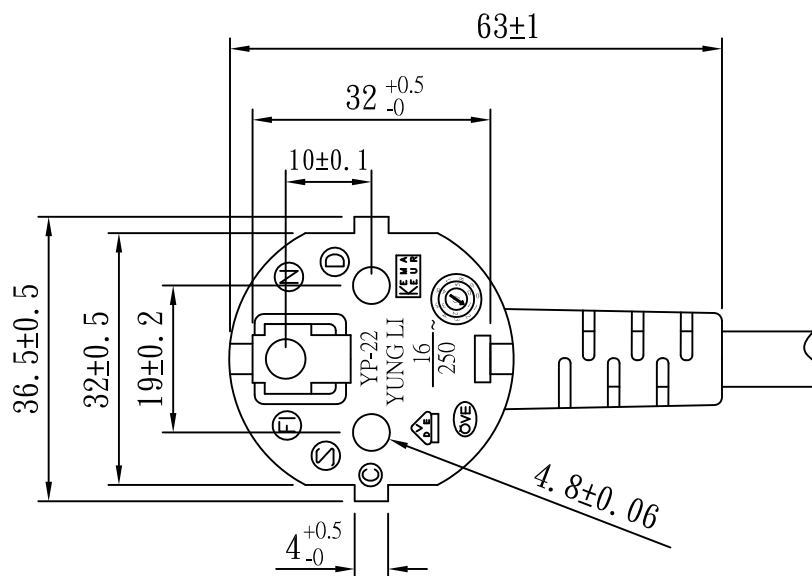
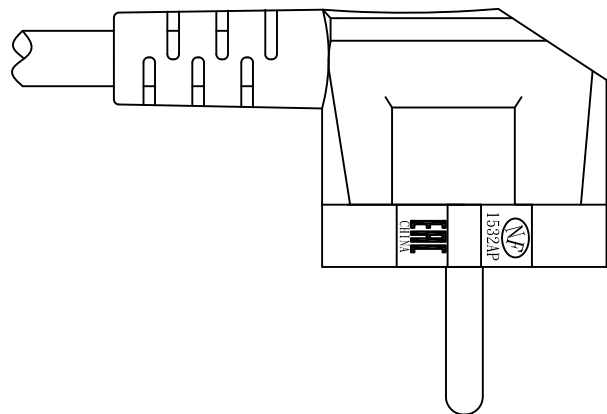
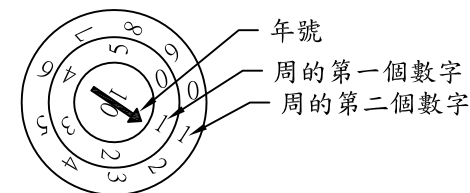
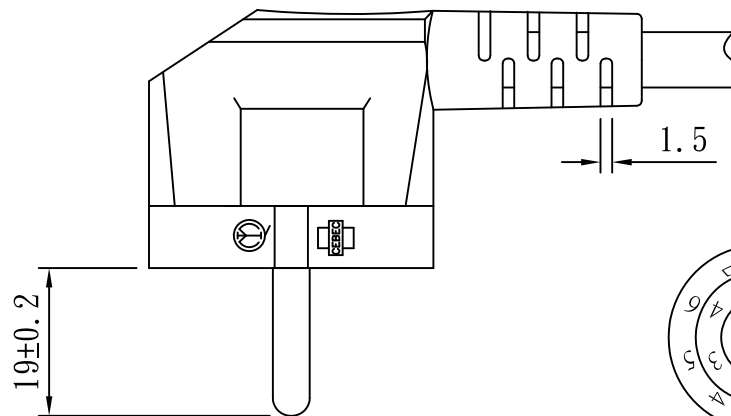
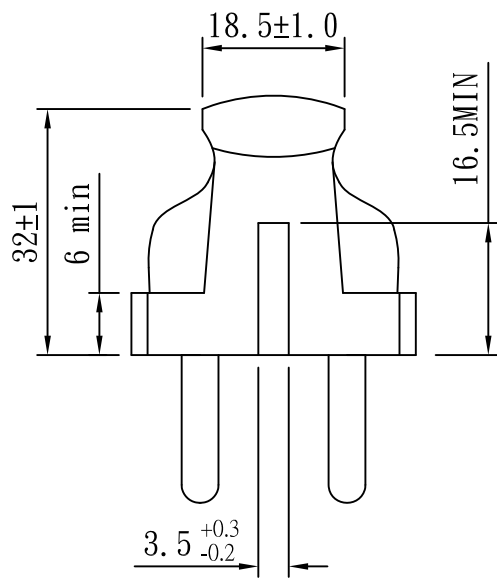

Tolerance >0±0.30 >1.0±0.50 >10.0±1.0 >20.0±2.0 Angle: ±1°	Approved		Date		YUNG LI CO., LTD.			
	Checked		Date					
	Drawn	SUKI	Date	16.04.22	Customer	MAG		
	Cat. No.	YP-22/YC-12L-2			P/N.			
	Drawing No.		Rev.	B	Material	P. V. C	Unit	mm
				Scale				

Sample Drawing NO. :
 SP160422-03

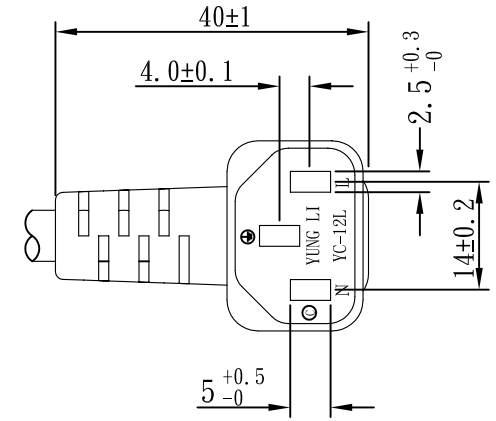
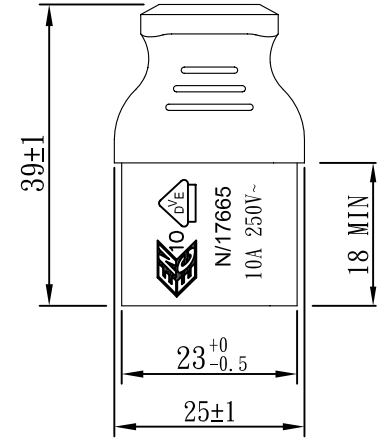
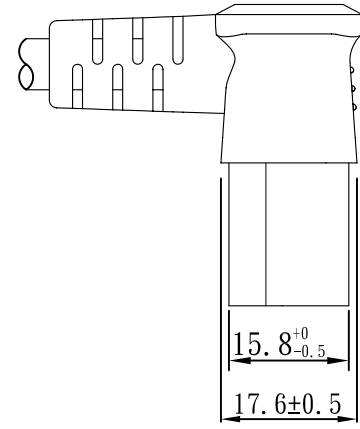
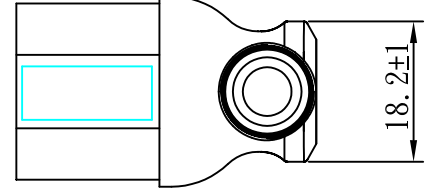
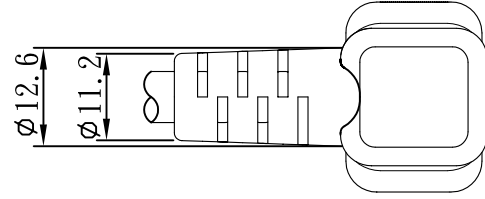

TOLERANCE >0±0.30 >1.0±0.50 >10.0±1.0 >20.0±2.0 Angle: ±1°	APPROVED		DATE		YUNG LI CO., LTD.			
	CHECKED		DATE					
	DRAWN		DATE					
	TYPE	YP-22			P/N			
	DRAWING NO				MATERIAL	P.V.C	UNIT	mm
					SCALE	1:1		



TOLERANCE >0±0.30 >1.0±0.50 >10.0±1.0 >20.0±2.0 Angle: ±1°	APPROVED		DATE		YUNG LI CO., LTD			
	CHECKED		DATE					
	DRAWN		DATE		CUSTOMER			
	TYPE	YC-12L-2			P/N			
	DRAWING NO.		REV	B	MATERIAL	P. V. C	UNIT	mm
				SCALE	1:1			

YUNG LI CO., LTD

SPECIFICATION









Yung Li	Style	PVC FLEXIBLE CORDS	Document No
2012.7.18			YL-V01004
Edition	Size	H05VV-F 3G 1.0mm²	Page
A			1/2

1. Standard: IEC 60227 IEC 60228

2. Construction & Dimension

	Item	Specification
Conductor	Size	3G 1.0mm ²
	Material	Annealed Bare Copper
	Construction	32/ § 0.202±0.005
Insulation	Material	PVC
	Minimum Average Thickness	0.60mm
	Minimum Thickness at any point	0.48mm
	Diameter	2.50 ± 0.10
	Identification	Blue,Brown,Yellow/Green
Core Assembly	Core Twist	3-Core
	Filler	NA
	Assembly Pair	NA
Taping	Mylar Foil	NA
Shielded	A1-Mylar Foil	NA
Drain	Material	NA
	Construction	NA
Jacket	Material	NA
	Minimum Average Thickness	0.8mm
	Minimum Thickness at any point	0.58mm
	Overall Diameter(Approx)	7.0± 0.15
	Color	Any Color

Marking:

Yung Li Co., Ltd. H05VV-F 3G 1.0mm² <VDE> NF-USE 1347  KEMA-KEUR  CEBEC <ÖVE>
     IEMMEQU ES0140750  A004049 60227 IEC 53(RVV) 300/500V  SU01027-4002

YUNG LI CO., LTD

SPECIFICATION

Yung Li	Style	PVC FLEXIBLE CORDS	Document No
2012.7.18			YL--V01004
Edition	Size	H05VV-F 3G 1.0mm²	Page
A			2/2

4. Electrical & Physical Properties

Item	Specification		
Rating Voltage	300/500V		
Maximum Temperature Rating	70°C		
Conductor resistance(AT 20°C)	19.5Ω/Km MAX		
Insulation Resistance(AT 70°C)	0.010MΩ · Km Min		
Dielectric Strength	AC 2.0 KV / 15 min No Break		
Spark Test	5.0KV		
Insulation	Unaged	Tensile Strength	1.02 kgf/mm ² min
		Elongation	150% Min
	Aged	Tensile Strength	80~120% (80°C x 168hrs)
		Elongation	80~120% (80°C x 168hrs)
	Loss of mass Test		2.0mg/cm ² (max)
Jacket	Unaged	Tensile Strength	1.02 kgf/mm ² min
		Elongation	150% Min
	Aged	Tensile Strength	80~120% (80°C x 168hrs)
		Elongation	80~120% (80°C x 168hrs)
	Loss of mass Test		2.0mg/cm ² (max)
Deformation Test		70±4°C X 1hr ≤ 50%	
Cold Bend Test		-15°C x 4hr No Crack	
Heat Shock Test		150±2°C x 1hr No Crack	

Graph:

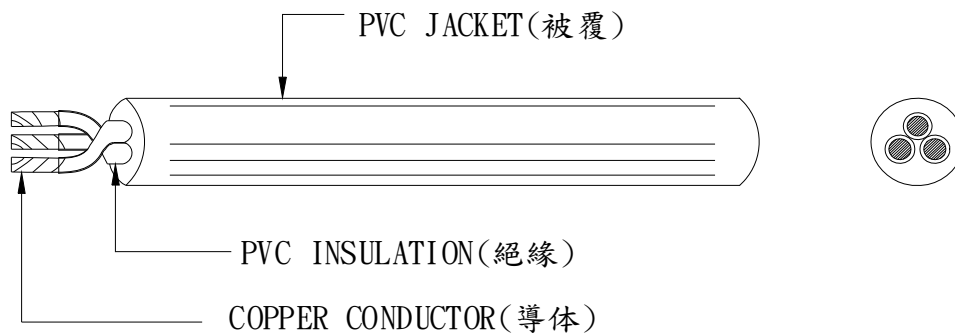

ZEICHENGENEHMIGUNG MARKS APPROVAL

Yung-Li Co. Ltd.
Da Pu Industrial Zone, Cang Zi
Chang Ping Town
523571 DONG GUAN CITY
Guangdong
CHINA

ist berechtigt, für ihr Produkt /
is authorized to use for their product

Stecker mit Schutzkontakt, nicht wiederanschließbar, umspritzt
Plug, with earthing contact, non-rewirable, moulded

die hier abgebildeten markenrechtlich geschützten Zeichen
für die ab Blatt 2 aufgeführten Typen zu benutzen /
the legally protected Marks as shown below for the types referred to on page 2 ff.



Geprüft und zertifiziert nach /
Tested and certified according to

DIN VDE 0620-2-1 (VDE 0620-2-1):2013-03

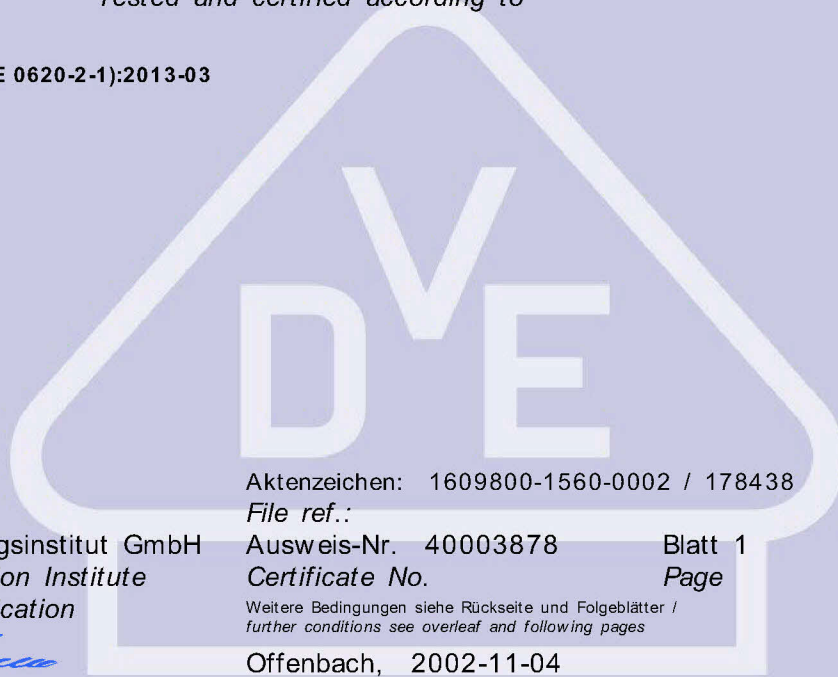

VDE Prüf- und Zertifizierungsinstitut GmbH
VDE Testing and Certification Institute
Zertifizierungsstelle / *Certification*

J. Gütermann
J. Gütermann

VDE Zertifikate sind nur gültig bei Veröffentlichung unter:
VDE certificates are valid only when published on:

Aktenzeichen: 1609800-1560-0002 / 178438
File ref.:

Ausweis-Nr. 40003878 Blatt 1
Certificate No. Page

Weitere Bedingungen siehe Rückseite und Folgeblätter /
further conditions see overleaf and following pages

Offenbach, 2002-11-04
(letzte Änderung/updated 2013-05-13)

<http://www.vde.com/zertifikat>
<http://www.vde.com/certificate>

Name und Sitz des Genehmigungs-Inhabers / *Name and registered seat of the Certificate holder*
Yung-Li Co. Ltd., Da Pu Industrial Zone, Cang Zi, Chang Ping Town, 523571 DONG GUAN CITY,
Guangdong, CHINA

Aktenzeichen / *File ref.*
1609800-1560-0002 / 178438 / CC1 / SHA

letzte Änderung / *updated* Datum / *Date*
2013-05-13 2002-11-04

Dieses Blatt gilt nur in Verbindung mit Blatt 1 des Zeichengenehmigungsausweises Nr. 40003878
This supplement is only valid in conjunction with page 1 of the Certificate No. 40003878.

Stecker mit Schutzkontakt, nicht wiederanschließbar, umspritzt
Plug, with earthing contact, non-rewirable, moulded

Typ(en) / *Type(s)*:

YP-22

Bemessungsspannung <i>Rated voltage</i>	AC 250 V
Bemessungsstrom <i>Rated current</i>	16 A
Polzahl <i>Number of poles</i>	2-polig mit zwei Schutzkontaktsystemen <i>2-pole with two earthing contact systems</i>
Bauart <i>Kind of construction</i>	DIN 49441-R2
Schutzart <i>Degree of protection</i>	IP20
Produktinformation <i>Product information</i>	siehe Anlage Nr. 400A + 401A + 900A <i>see Appendix No. 400A + 401A + 900A</i>

VDE Prüf- und Zertifizierungsinstitut GmbH
VDE Testing and Certification Institute
Abteilung CC1
Section CC1

OVE AUSTRIAN ELECTROTECHNICAL ASSOCIATION
Eschenbachgasse 9, 1010 Wien, Austria
ZVR: 327279890 | DVR: 1055887

OVE - Testing & Certification
Kahlenberger Str. 2A, 1190 Wien, Austria
Phone: +43 1 370 58 06
www.ove.at



Page 1 of 2

ÖVE-CERTIFICATE

including the entitlement to use the Austrian Safety Mark



Certificate No.: **21721-006-04**

Valid from: 2015 02 17
until: 2017 02 17

The Austrian Electrotechnical Association (OVE) hereby grants the right to the company mentioned below to label the listed products with the Austrian Safety Mark.

Company: **Yung Li Co. Ltd.**
Da Pu Industrial Zone, Gang Zi, Chang Ping Town
523571 Dong Guan City, Guang Dong Province
China

Product: **Non rewirable two pole plug with dual earthing system**

Basis for this given right is the conformity of the products with the requirements of the technical standards listed in this certificate as stated in the file(s) Ref.-No(s). **1740-1182/03**.

This certificate establishes the conformity of the tested specimen and of all products manufactured strictly identical to the submitted one.

Österreichischer Verband für Elektrotechnik
Head of Testing & Certification



Vienna, 2015 01 12

Digitally signed by W. Martin
Email=w.martin@ove.at
Dipl.-Ing. W. Martin

OVE - Testing & Certification

Accredited by the Federal Ministry of Science, Research and Economy as Certification Body for products within the scope as given in the official decree and published under www.en.bmfwf.gv.at/accreditation





Österreichischer Verband
für Elektrotechnik

Certificate No.: 21721-006-04

Date: 2015 01 12

Page 2 of 2

Manufacturer:

Yung Li Co. Ltd.
Da Pu Industrial Zone, Gang Zi, Chang Ping Town
523571 Dong Guan City, Guang Dong Province
China

Factory location(s):

Yung Li Co. Ltd.
Da Pu Industrial Zone, Gang Zi, Chang Ping Town
523571 Dong Guan City, Guang Dong Province
China

Tested and certified according to:

ÖVE/ÖNORM IEC 60884-1:2005-09-01

Product: Non rewirable two pole plug with dual earthing system

Type designation:

Trademark:

Rating:

YP-22

Rated voltage: AC 250 V
Rated current: 16 A
H03VV-F 3 G 0,75

YUNG LI

YP-22

Rated voltage: AC 250 V
Rated current: 16 A
H05VV-F 3 G 0,75

YUNG LI

YP-22

Rated voltage: AC 250 V
Rated current: 16 A
H05VV-F 3 G 1

YUNG LI

YP-22

Rated voltage: AC 250 V
Rated current: 16 A
H05VV-F 3 G 1,5

YUNG LI

OVE - Testing & Certification

Accredited by the Federal Ministry of Science, Research and Economy as Certification Body for products within the scope as given in the official decree and published under www.en.bmwf.gv.at/accreditation





LCIE

Accréditation
N°5-0014
Portée
disponible sur
www.cofrac.fr



LICENCE



LCIE N° 621358

Délivrée à:
Delivered to: **YUNG LI Co., Ltd**
1F, No 10, Lane 235, Pao-Chiang Road, Hsin-Tien - TAIPEI - TAIWAN

Site de fabrication:
Factory: **YUNG LI Co., Ltd. (1532AP)**
Da Pu Industrial Zone, Gang Zi, Chang Ping Town - Dong Guan City - GUANG DONG PROVINCE 523571 - CHINE

Produit:
Product: **Fiche de prise de courant**
Plug

Marque commerciale (s'il y a lieu):
Trade mark (if any): **YUNG-LI**

Modèle, type, référence:
Model, type, reference: **YP-22**

Caractéristiques nominales et principales:
Rating and principal characteristics: **16A 250V~, 2P avec contact de terre/2P with dual earthing contact voir annexe/see annex**

Informations complémentaires:
Additional informations: **Mise à jour suite à évolution de la norme**
update further to the evolution of the standard

Le produit est conforme à:
The product is in conformity with: **NF C 61-314:2008 +A1:2010**

Documents pris en compte:
Relevant documents: **Rapport d'essai/test report n° BVCB11DE1038ACSP, certificat d'essai OC/CB test certificate n° DE1-42031 / TR 1609800-1560-0002/122934**

Annule et remplace (s'il y a lieu):
Cancels and replaces (if necessary): **Licence n°555296 du 2007-02-08**

En vertu de la présente décision notifiée par le LCIE France organisme mandaté, AFNOR Certification accorde le droit d'usage de la Marque NF à la société qui en est titulaire pour les produits visés ci-dessus, dans les conditions définies par les règles générales de la Marque NF et par les règles de certification NF, pour autant que les contrôles réguliers de la fabrication et les vérifications par tierce partie soient satisfaisants.

On the strength of the present decision notified by LCIE France mandated certification body, AFNOR Certification grants the right to use the NF Mark to the licence holder for the above mentioned products, within the frame of the general rules of the NF Mark and of the NF certification rules, as far as the regular checking and third party verifications of the production are satisfactory.

Fontenay-aux-Roses, 2012-01-11

Michel BRENON

Directeur de la Certification
Certification Manager

Date limite de validité :

Limit expired date :

La validité de la présente licence cesse dès l'annulation de l'une des normes sur laquelle elle est fondée.
The present licence is valid until the cancellation of one of the standards on which it is based.

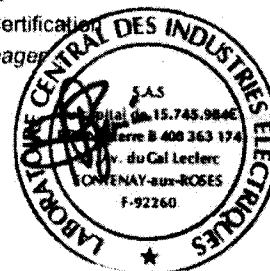

PID:
02113100
CID:
C.1996.5269

Certificato di approvazione

Approval certificate

IMQ, ente di certificazione accreditato, autorizza la ditta *IMQ, accredited certification body, grants to*

YUNG LI CO., LTD.
DA PU IND. ZONE, GangZi, CHANG PING TOWN
DONG GUAN CITY, GUANG DONG PROV.
CN - China

all'uso del marchio

the licence to use the mark

IMQ

Il presente certificato è soggetto alle condizioni previste nel "Regolamento IMQ - Certificazione prodotto" ed è relativo ai prodotti descritti nell'Allegato al presente certificato.



per i seguenti prodotti

for the following products

**Spine indissolubilmente
collegate al cavo
(Rif. di tipo YP-22)**

*Non-rewirable plugs
(Type ref. YP-22)*

This certificate is subjected to the conditions foreseen by "IMQ Rules - Product Certification" and is relevant to the products listed in the annex to this certificate.

Emesso il | Issued on **2003-04-17**
Aggiornato il | Updated on **2011-09-21**
Sostituisce | Replaces **2008-06-17**

IMQ S.p.A.

Allegato - Certificato di approvazione
Annex - Approval certificate

Emesso il / Issued on 2003-04-17
Aggiornato il / Updated on 2011-09-21
Sostituisce / Replaces 2008-06-17

Prodotto | Product

Spine indissolubilmente collegate al cavo
Non-rewirable plugs

Concessionario | Licence Holder

YUNG LI CO., LTD.
DA PU IND. ZONE, GangZi, CHANG PING TOWN
DONG GUAN CITY, GUANG DONG PROV.
CN - China

Marchio | Mark



IMQ

Costruito a | Manufactured at

PI.B000M3 C01175219

DONG GUAN CITY, GUANG DONG PROV.

China

Copia del presente certificato deve essere conservata presso i luoghi di produzione sopra elencati.

Copy of this certificate must be available at the manufacturing places listed above

Norme

CEI 23-50 - II Ed. 2007 + V1:2008

Standards

CEI 23-50 - II Ed. 2007 + V1:2008

Rapporti | Test Reports

26LL00072

Caratteristiche tecniche | Technical characteristics

Designazione | Type designation **2P+T+T S31 / 2P+E+E S31**
Tensione nominale | Rated voltage **250 V**
Corrente nominale | Rated current **16 A**
Grado di protezione | Degree of protection (IP) **IP20**
Tipo di morsetti | Type of terminals **morsetti aggraffati / crimped connections**
Materiale della custodia | Material of the cover **termoplastico / thermoplastic**
Uscita cavo | Cable exit **a squadra / angled**

Articoli (con dettagli) | Articles (with details)

AR.D0022W

Marca | Trade mark **YUNG-LI**
Riferimento di tipo | Type reference **YP-22**
Tipo di cavo | Type of cable **H03VV-F**
Sezione nominale | Section areas **3G0,75 mm²**

AR.D0022X

Marca | Trade mark **YUNG-LI**
Riferimento di tipo | Type reference **YP-22**
Tipo di cavo | Type of cable **H05VV-F**
Sezione nominale | Section areas **3G0,75 mm²**

AR.D0022Y

Marca | Trade mark **YUNG-LI**
Riferimento di tipo | Type reference **YP-22**
Tipo di cavo | Type of cable **H05VV-F**
Sezione nominale | Section areas **3G1 mm²**

AR.D0022Z

Marca / Trade mark **YUNG-LI**
Riferimento di tipo / Type reference **YP-22**
Tipo di cavo / Type of cable **H05VV-F**
Sezione nominale / Section areas **3G1,5 mm²**

Ulteriori informazioni | Additional Information

La spina rif. di tipo YP-22 è prodotta col seguente inserto:
marca: GEM ; art.: P98651.

The non-rewirable plug type ref. YP-23 is manufactured with the following insert:
trade mark: GEM; art.: P98651.

Componenti | Component List

Rif. di tipo/Type ref. YP-22

Tipo / Type	(*)	Costruttore / Manufacturer	Riferimento / Type Ref.	Dati / Data	Norme / Standard (*)	Marchi / Marks
Cavo / Cable	2/4	YUNG LI	YUNG LI	H03VV-F	-	IMQ
Cavo / Cable	2/4	YUNG LI	YUNG LI	H05VV-F	-	IMQ

Emesso il / Issued on **2008-06-17** Data di aggiornamento / Updated on **2011-09-21** Sostituisce / Replaces **2008-06-17**

Ciascun componente è contraddistinto da un numero avente il seguente significato:

- 1 - Componente marchiato e sostituibile con altro pure marchiato con caratteristiche equivalenti
- 2 - Componente sostituibile solo previa autorizzazione dell'IMQ
- 3 - Componente (integrato nell'apparecchio utilizzatore) provato congiuntamente all'apparecchio utilizzatore
- 4 - Componente in alternativa
- 5 - Componente per uso opzionale
- 6 - Componente da abbinare

Each component is signed by a number having the following meaning:

- 1 - Approved component replaceable with another one also approved with equivalent characteristics
- 2 - Component replaceable with IMQ authorization only
- 3 - Integrated component tested together with appliances
- 4 - Alternative component
- 5 - Component for optional use
- 6 - Component to be matched

(*) Queste colonne sono compilate a cura di IMQ / These columns are filled in by IMQ

Diritti di concessione | Annual Fees

SN.D000DL BTL.021100.DA19 Diritti modelli IMQ - 0211 - Prese, spine e connettori di uso domestico | IMQ models - 0211 - Plugs and appliance couplers for domestic purposes

1



IMQ S.p.A.

DEMKO CERTIFICATE

Certificate No. D-01830
Page 1/3
Date of Issue 2012-10-30

Certificate Holder YUNG LI CO LTD
DA PU INDUSTRIAL ZONE
CHANG PING TOWN
DONGGUAN, 523571 GUANGDONG China

Manufacturer YUNG LI CO LTD
DA PU INDUSTRIAL ZONE
CHANG PING TOWN
DONGGUAN, 523571 GUANGDONG China

Production site YUNG LI CO LTD
DA PU INDUSTRIAL ZONE
CHANG PING TOWN
DONGGUAN, 523571 GUANGDONG China

Certified Product Model Non-rewirable Two-pole plug with dual earthing contacts
YP-22

Trademark

YUNG LI

Rated Voltage / Frequency 250 V~
Rated Current / Power 16 A
Insulation Class -
Degree of protection (IP) 20
Tested acc. to DS 60884-2-D1:2011
Test Report No. 12CA56486 issued on 2012-10-25
Additional
Expire date 2022-10-30

Certification Manager
Jan-Erik Storgaard

Certification Body

The product and production sites listed on the certificate comply with the D-mark requirements and the UL Global Service Agreement, with reference to Terms and Conditions for the D mark. The Owner of the certificate is entitled to use the d or for cables <DEMKO>, for the products listed on the certificate and manufactured at the production sites listed. UL has to be informed in writing about any changes to the product or production site in accordance with the Term and Conditions of the D mark. The validity of the certificate is shortened if the EU legislation require re-testing and re-certification due to new standards or amendments coming into force before the expiry date.

**UL International Demko A/S, Borupvang 5A, DK-2750
Ballerup, Denmark, Tel. +45 44 85 65 65,
info.dk@ul.com
www.ul-europe.com**



Appendix DEMKO CERTIFICATE

Certificate No. D-01830
Page 2/3
Date of Issue 2012-10-30

Additional Information:

YP-22 with cord
H03VV-F 3G 0.75 mm², H05VV-F 3G 0.75, 1.0, 1.5 mm²,
H03V2V2-F 3G 0.75 mm², H05V2V2-F 3G 0.75, 1.0, 1.5 mm²,
H05RR-F 3G 0.75, 1.0, 1.5 mm², H05RN-F 3G 0.75, 1.0 mm²,
H07RN-F 3G 1.0, 1.5 mm².

Standard Sheet: C4 (CEE 7: VII)

Certification Body

UL International Demko A/S, Borupvang 5A, DK-2750
Ballerup, Denmark, Tel. +45 44 85 65 65,
info.dk@ul.com
www.ul-europe.com



Appendix DEMKO CERTIFICATE

Certificate No. D-01830
Page 3/3
Date of Issue 2012-10-30

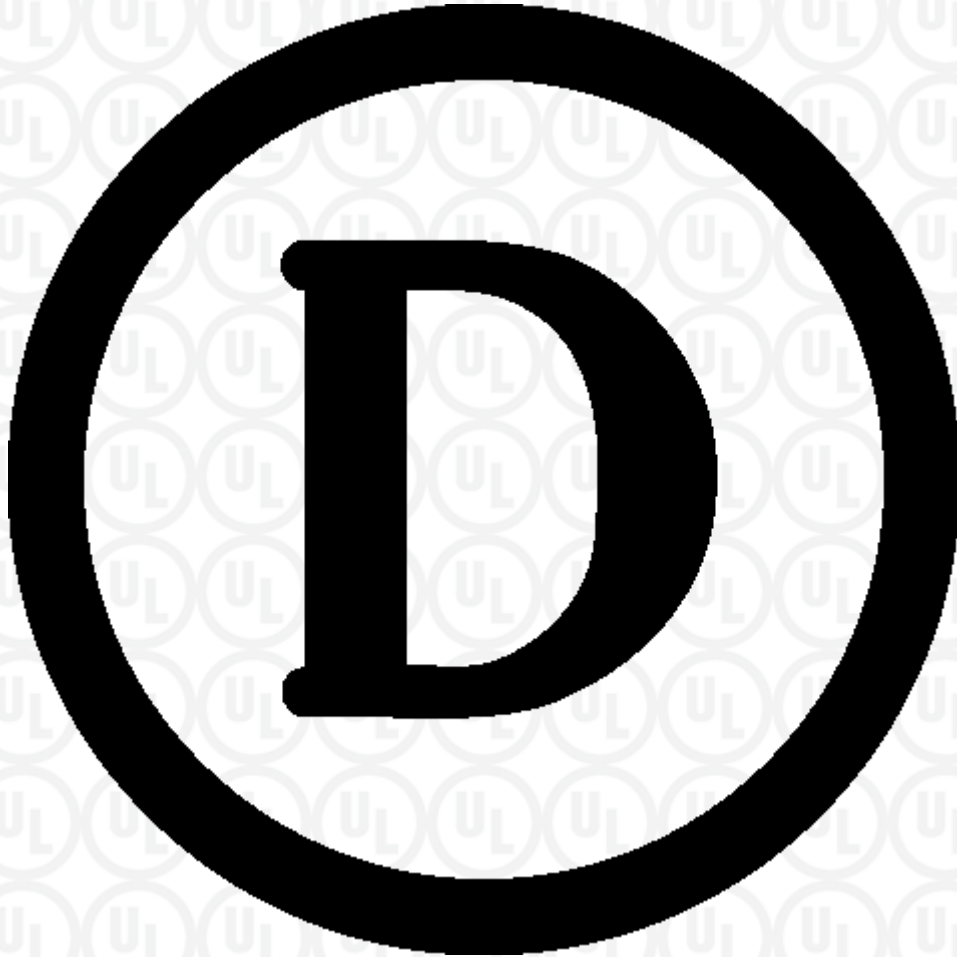

Certification Body

UL International Demko A/S, Borupvang 5A, DK-2750
Ballerup, Denmark, Tel. +45 44 85 65 65,
info.dk@ul.com
www.ul-europe.com



Product	Plugs
Applicant	Yung-Li Co., Ltd. Da Pu Industrial Zone, Chang Ping Town Dongguan City, Guang Dong Province 523571 China
Manufacturer	Yung-Li Co., Ltd. Da Pu Industrial Zone, Chang Ping Town Dongguan City, Guang Dong Province 523571 China
Factory	Yung-Li Co., Ltd. Da Pu Industrial Zone, Chang Ping Town Dongguan City, Guang Dong Province 523571 China <input type="checkbox"/> See next page(s)
Ratings	16A 250V AC
Trade mark	YUNG-LI
Model / Type Ref.	YP-22
Principal characteristics	Non-rewirable two-pole plug with dual earthing-contacts. Standard Sheet VII. Thermoplastic, with H03VV-F 3G0.75mm ² <input type="checkbox"/> See next page(s)
A sample of the product was tested and found to be in conformity with	INST NEK-IEC 60884-1:2002;am1 and NEK 502:2006
Validity	This certificate documents conformity with the standards shown, and also applies as license for use of Nemkos name and certification mark. The certificate and license is valid as long as the applicable conditions are complied with, and provided that any changes to the product are notified to Nemko for acceptance prior to implementation. New standards or amendments to the standards may imply that the product design must be updated and/or that re-testing and re-certification is necessary.
Additional information	<input type="checkbox"/> See next page(s)
Additional model(s)	<input checked="" type="checkbox"/> See next page(s)

Date of issue 16-10-2013



Signature

Hanne Yndestad

Certification Department

Nemko AS

Office address

Internet

Telephone

Fax

P.O. Box 73, Blindern

Gaustadalléen 30

www.nemko.com

+47 22 96 03 30

+ 47 22 96 05 50

N-0314 Oslo, Norway

Oslo

Enterprise number:

NO 974404532

Product	Plugs
Pos. No	1
Model / Type Ref.	YP-22
Trade mark (if different from page 1)	
Rating	16A 250V AC
Principal characteristics	Non-rewirable two-pole plug with dual earthing-contacts. Standard Sheet VII. Thermoplastic, with H05VV-F 3G0.75-1.5mm ²

Date of issue 16-10-2013

Hanne Yndestad

Signature

Hanne Yndestad

Certification Department

Certificate



Intertek

for European Product Safety

Reference No. 1600036

Plug, non rewirable

Type designation	YP-22
Certificate holder	YUNG LI CO. LTD. DA PU INDUSTRIAL ZONE GANGZI CHANG PING TOWN DONGGUAN, 523571 GUANGDONG CHINA
The product complies with the standard(s)	IEC 60884-1:2002 + A1 + A2 SS 428 08 34:2013
Date of expiry	12 February 2021

Additional information in Appendix.

Certification Body Intertek Semko AB, Product Certification Place Kista - Stockholm

Signed

Bo Berglöf

Date 12 February 2016
Page 1 of 2

This certificate is issued in accordance with the terms and conditions set out in the Appendix.



**Intertek
Appendix**

Reference No. 1600036

Technical data

Type designation	YP-22
Rated voltage (V)	250~
Rated current (A)	16
IP-Class	20
Type of cord	H03VV-F 3G0,75mm ² H05VV-F 3G0,75-1,5mm ² H05RN-F 3G0,75-1,0mm ² H05V2V2-F 3G0,75-1,5mm ² H03V2V2-F 3G0,75mm ²
Standard sheet	CEE 7/VII
Trade mark	YUNG LI
Product information	Non rewirable plug for class I equipments. With angled cord entry.

This certificate replaces previously issued ref. No. 1312344 dated 2013-10-29 for YUNG LI CO. LTD. A new certificate has been issued on account of updating the standard.

The certificate applies for countries that have sanctioned the use of plugs/outlets according to subject standard sheet and component standard.

Manufacturing site(s) YUNG LI CO. LTD.
DA PU INDUSTRIAL ZONE
GANGZI CHANG PING TOWN
DONGGUAN, 523571 GUANGDONG
CHINA

Certification Body Intertek Semko AB, Product Certification *Place* Kista - Stockholm

Signed 
Bo Berglöf *Date* 12 February 2016

This Certificate is for the exclusive use of Intertek's Client and is provided pursuant to the Certification agreement between Intertek and its Client. Intertek's responsibility and liability are limited to the terms and conditions of the agreement. Intertek assumes no liability to any party, other than to the Client in accordance with the agreement, for any loss, expense or damage occasioned by the use of this certificate. Only the Client is authorized to permit copying or distribution of this certificate and then only in its entirety. Use of Intertek's Certification mark is restricted to the conditions laid out in the agreement. Any further use of the Intertek name for the sale or advertisement of the tested material, product or service must first be approved in writing by Intertek. Initial Factory Assessments and Follow up Services are for the purpose of assuring appropriate usage of the Certification mark in accordance with the agreement, they are not for the purposes of production quality control and do not relieve the Client of their obligations in this respect.

CERTIFICATE

Issued to:
Applicant:
Yung Li Co., Ltd.
Da Pu Industrial Zone, Chang Ping Town
523571 Dongguan City, China

Manufacturer/Licensee:
Yung Li Co., Ltd.
Da Pu Industrial Zone, Chang Ping Town
523571 Dongguan City, China

Product : plug, (2-pole)
Trade name : YUNG LI
Type/model : YP-22

The product and any acceptable variation thereto is specified in the Annex to this certificate and the documents therein referred to.

DEKRA hereby declares that the above-mentioned product has been certified on the basis of:

- a type test according to the standard IEC 60884-1:2002 + A1:2006 and NEN 1020:1987 + A2:2004
- an inspection of the production location according to CENELEC Operational Document CIG 021
- a certification agreement with the number 2078870

DEKRA hereby grants the right to use the KEMA-KEUR certification mark.

The KEMA-KEUR certification mark may be applied to the product as specified in this certificate for the duration of the KEMA-KEUR certification agreement and under the conditions of the KEMA-KEUR certification agreement.

This certificate is issued on 16 November 2012 and expires upon withdrawal of one of the above mentioned standards.

Certificate number: 2158219.01

DEKRA Certification B.V.



drs. G.J. Zoetbrood
Managing Director



H.R.M. Barends
Certification Manager

© Integral publication of this certificate is allowed

All testing, inspection, auditing and certification activities of the former KEMA Quality are an integral part of the DEKRA Certification Group.

ACCREDITED BY
THE DUTCH COUNCIL
FOR ACCREDITATION



SPECIFICATION OF THE CERTIFIED PRODUCT
Product data

product	: plug, (2-pole)
trade name	: YUNG LI
type	: YP-22, YP-22
rated current	: 16 A
rated voltage	: 250 V~
earthing	: with dual earthing contacts
design	: non-rewirable, angled
standard sheet	: VII
description	: body of thermoplastic material as part of a complete or incomplete cord set for class I appliances
markings	: are shown on the body

List of components

Component	trade name	type/model	approval mark ¹⁾
insert	GEM Terminal Ind. Co., Ltd.	98651A-VDE	*

¹⁾ * indicates a component tested as part of the appliance

Product data - type YP-22

applied flexible cords	: H05RR-F 3G1,5 mm ² H07RN-F 3G1,0 and 3G1,5 mm ²
certification mark	: complies with the specified requirements
cord termination	: crimped connection
design	: big cord guard

Product data - type YP-22

applied flexible cords	: H03VV-F 3G0,75 mm ² H03V2V2-F 3G0,75 mm ² H05VV-F 3G0,75, 3G1,0 and 3G1,5 mm ² H05V2V2-F 3G0,75, 3G1,0 and 3G1,5 mm ² H05RR-F 3G0,75 and 3G1,0 mm ² H05RN-F 3G0,75 and 3G1,0 mm ²
certification mark	: complies with the specified requirements
cord termination	: crimped connection
design	: small cord guard

TESTS
Test requirements

IEC 60884-1:2002 + A1:2006
NEN 1020:1987 + A2:2004

Test result

The test results are laid down in DEKRA test file 2158219.01.

Remarks

This certificate replaces our certificate 2026550.01 dated 2003-01-20 and is partly based on VDE CB Test Certificate DE1-42031 dated 2009-10-12.

Conclusion

The examination proved that all test requirements were met.

Tested by : VDE

Checked by : M.A.R. Bollen

**Factory locations**

Yung Li Co., Ltd.

Da Pu Industrial Zone, Chang Ping Town
523571 Dongguan City, China

LICENCE

No. 18291 replaces No.12989

Issued to:

Applicant:

Yung Li Co. Ltd.

1F, No.10, Lane 235,

Pao-Chiao Road

Hsin-Tien, New Taipei, Taiwan

Licensee:

Yung Li Co. Ltd.

1F, No.10, Lane 235,

Pao-Chiao Road

Hsin-Tien, New Taipei, Taiwan



Product : plugs (2-pole) for household purposes

Trade name(s) : YUNG-LI

Type(s)/model(s) : YP-22

The product and any acceptable variation thereto is specified in the annex to this licence and the documents therein referred to.

SGS CEBEC hereby declares that the above-mentioned product has been certified on the basis of:

- a type test according to the standard specified in annex
- an inspection of the production location
- a certification agreement with the number 1031

SGS CEBEC hereby grants the right to use the CEBEC certification mark

The CEBEC certification mark may be applied to the product as specified in this licence for the duration of the CEBEC certification agreement and under the conditions of the CEBEC certification agreement.

This licence is issued on: 26/03/2013

ir. C. Lana,
Certification Manager

© Only integral publication of this certificate, including the annex, is allowed

This certificate is only valid combined with the publication on the following web address: www.sgs.com/ee

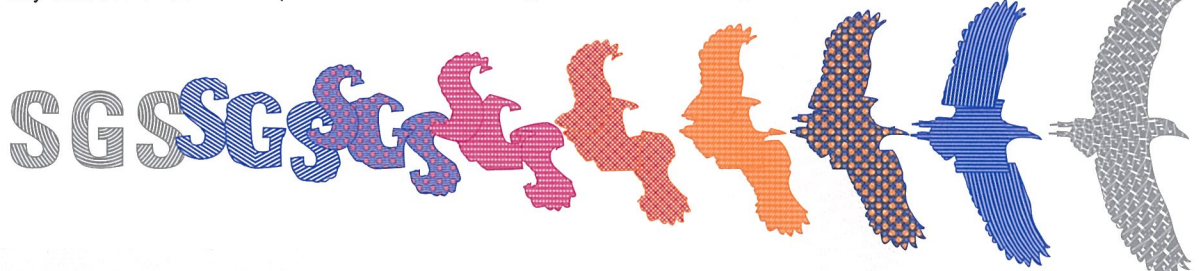

SPECIFICATION OF THE CERTIFIED PRODUCT

Product data

Product	:	plugs (2-pole) for household purposes
Trade name(s)	:	YUNG-LI
Type(s)/Model(s)	:	YP-22
rated current (In)	:	16 A
rated voltage (Un)	:	250 Vac
earthing	:	with dual earthing system
design	:	non-rewirable angled cable entry
class	:	for class I appliances
standard sheet	:	VII of CEE 7
applied flexible cord(s)	:	H03 VV-F 3G0.75 mm ² H05 VV-F 3G0.75-1.5 mm ² H03V2V2-F 3 G 0,75 mm ² H05V2V2-F 3 G 0,75-1.5 mm ²
description	:	body of thermoplastic material as part of an incomplete cord set for class I appliances
applied flexible cord(s) (cont'd)	:	H05RR-F 3 G 0,75-1,5 mm ² H05RN-F 3 G 0,75-1.0 mm ² H07RN-F 3 G 1,0-1,5 mm ²
cord(s) termination	:	crimped connection
certification mark	:	complies with the requirements
markings	:	are shown on the body

Additional information

Live part carriers: PBT, type 4115, black, Chang Chun Plastics.
Moulding: PVC, type Flex 60 O, all colours, Pure Friend Business Enterprise Corp.
Insert: GEM

TESTS

Test requirements

NBN C 61-112-1 based on IEC 60884-1:2002 + A1:2006

Test results

The test results are laid down in certification file ref.596812/01

Remarks

This certificate is based on certificate ref. CB DE1-42031 and test report(s) ref. 1609800-1560-0002/122934

Conclusion

The examination proved that all test requirements were met.

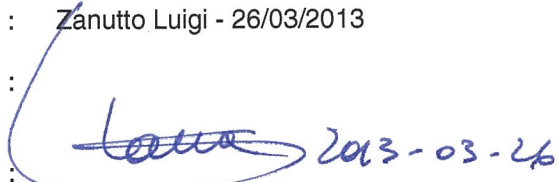
Checked by, project leader : Zanutto Luigi - 26/03/2013
Department Manager, :
Product Certification : 
Certification Manager :

FACTORY LOCATION(S)

Yung Li Co., Ltd.
Da Pu Industrial Zone, GanZi
Chang Ping Town, Dong Guan City
523571 Guang Dong Province
China

SGS



CERTIFICATE FI 26869

Our Ref. 264459

Product Plug, non-rewirable

Type YP-22, with cord H03VV-F 3G0,75
YP-22, with cord H03V2V2-F 3G0,75
YP-22, with cord H05VV-F 3G0,75-1-1,5
YP-22, with cord H05V2V2-F 3G0,75-1-1,5

Trade mark YUNG LI

Certificate Holder Yung-Li Co., Ltd.
Da Pu Industrial Zone, Chang Ping Town
Dongguan City 523571
GUANG DONG PROVINCE
CHINA

Manufacturer Yung-Li Co., Ltd.
Da Pu Industrial Zone, Chang Ping Town
Dongguan City 523571
GUANG DONG PROVINCE
CHINA

Technical Information 16 A, 250 V~

Other Information Standard sheet CEE 7 / VII, for class I equipments.

The product is certified according to the following standard(s) IEC 60884-1:2002 (Ed 3) + A1:2006
SFS 5610:2004 + A1:2008

Validity This certificate is valid until 14 June 2016 unless the standard in question has been amended or superseded with significant changes in requirements. In which case, SGS Fimko has the right to shorten the validity of the certificate based on the legislation of the European Union. This certificate includes the right to use the FI mark under the condition that changes (if any) will be checked at SGS Fimko before the product is brought onto market and that the conditions for FI certification are met.

Date of issue 14 June 2011

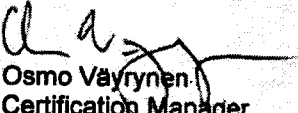
Signature 
Osmo Väyrynen
Certification Manager

This certificate has 1 appendix



This certificate is issued by the company under its General Conditions for Certification Services accessible at www.sgs.com/terms_and_conditions.htm. Attention is drawn to the limitations of liability defined therein and in the Test Report here above mentioned which findings are reflected in this certificate. Any unauthorized alteration, forgery or falsification of the content or appearance of this document is unlawful and offenders may be prosecuted to the fullest extent of the law.

SGS Fimko Ltd.

Särkiniementie 3 P.O.Box 30 FI-00211 Helsinki, Finland
t. +358 9 898 361 f. +358 9 892 5474 www.fi.sgs.com

Business ID 0978538-5

Member of the SGS Group (SGS SA) certificate



Appendix to Certificate: 26869

Manufacturing sites

Yung-Li Co., Ltd.
Da Pu Industrial Zone, Chang Ping Town
Dongguan City 523571
GUANG DONG PROVINCE
CHINA

Additional information

The product has certificate DE1-42031 issued by VDE Testing and Certification Institute in accordance with the CB system.

Our ref.

264459



СЕРТИФИКАТ СООТВЕТСТВИЯ

№ ТС ВУ/112 02.01. 020 03966

Серия ВУ № 0038758

ОРГАН ПО СЕРТИФИКАЦИИ

Открытое акционерное общество «Испытания и сертификация бытовой и промышленной продукции «БЕЛЛИС»;
 юридический адрес: Республика Беларусь, 220029, г. Минск, ул. Красная, 7Б;
 фактический адрес: Республика Беларусь, 220029, г. Минск, ул. Красная, 8; телефон: +375 17 288 16 41;
 факс: +375 17 288 16 41; e-mail: bellis@bellis.by; аттестат аккредитации № ВУ/112.020.02 от 22.03.2011,
 Республиканское унитарное предприятие «Белорусский государственный центр аккредитации».

ЗАЯВИТЕЛЬ

YUNG LI CO., LTD.,
 юридический адрес: Da Pu Industrial Zone, Chang Ping Town, Dong Guan City, Guangdong, 523571, Китай;
 фактический адрес: Da Pu Industrial Zone, Chang Ping Town, Dong Guan City, Guangdong, 523571, Китай;
 телефон: + 8676983335989; факс: + 8676983396796; e-mail: eng@yung-li.com

ИЗГОТОВИТЕЛЬ

YUNG LI CO., LTD., Da Pu Industrial Zone, Chang Ping Town, Dong Guan City, Guangdong, 523571, Китай

ПРОДУКЦИЯ

Вилка (plug, non rewirable) YUNG-LI модель YP-23

серийный выпуск

8544 42 290 0

КОД ТН ВЭД ТС

СООТВЕТСТВУЕТ ТРЕБОВАНИЯМ

Технический регламент Таможенного союза «О безопасности низковольтного оборудования»
 ТР ТС 004/2011; ГОСТ Р 51322.1-2011

СЕРТИФИКАТ ВЫДАН НА ОСНОВАНИИ

протокола аккредитованной испытательной лаборатории «БЕЛЛИС», ВУ/112 02.1.0.0001,
 №№ 101-14-2650 от 22.12.2014;
 отчета о проверке производства от 05.11.2014.

ДОПОЛНИТЕЛЬНАЯ ИНФОРМАЦИЯ

СРОК ДЕЙСТВИЯ С 23.12.2014 ПО 22.12.2019



Руководитель (уполномоченное
лицо) органа по сертификации

Эксперт-аудитор (эксперт)

[Handwritten signature]
подпись

[Handwritten signature]
подпись

А.Г. Раковский
инициалы, фамилия

А.В. Сиводед
инициалы, фамилия

VDE Prüf- und Zertifizierungsinstitut

ZEICHENGENEHMIGUNG MARKS APPROVAL

Yung-Li Co. Ltd.
Da Pu Industrial Zone
Chang Ping Town
523571 DONG GUAN CITY
Guangdong
CHINA

ist berechtigt, für ihr Produkt /
Is authorized to use for their product

Gerätesteckdose, nicht-wiederanschließbar
Connector, non-rewirable

die hier abgebildeten markenrechtlich geschützten Zeichen
für die ab Blatt 2 aufgeführten Typen zu benutzen /
the legally protected Marks as shown below for the types referred to on page 2 ff.



Geprüft und zertifiziert nach /
Tested and certified according to

DIN EN 60320-1 (VDE 0625-1):2008-05; EN 60320-1:2001 + A1:2007



VDE Prüf- und Zertifizierungsinstitut GmbH
VDE Testing and Certification Institute
Zertifizierungsstelle / Certification

Aktenzeichen: 1609800-1550-0003 / 116615

File ref.:

Ausweis-Nr. 40029577

Blatt 1

Certificate No.

Page

Weitere Bedingungen: siehe Rückseite und Folgebilder /
further conditions see overleaf and following pages

Offenbach, 2010-03-05

VDE Zertifikate sind nur gültig bei Veröffentlichung unter:
VDE certificates are valid only when published on:

<http://www.vde.com/zertifikat>
<http://www.vde.com/certificate>

VDE



VDE Prüf- und Zertifizierungsinstitut

Zeichengenehmigung

Ausweis-Nr. / Blatt /
Certificate No. page
40029577 2

Name und Sitz des Genehmigungs-Inhabers / *Name and registered seat of the Certificate holder*
Yung-Li Co. Ltd., Da Pu Industrial Zone, Chang Ping Town, 523571 DONG GUAN CITY, Guangdong,
CHINA

Aktenzeichen / *File ref.*
1609800-1550-0003 / 116615 / FG31 / E

Datum / *Date*
2010-03-05

Dieses Blatt gilt nur in Verbindung mit Blatt 1 des Zeichengenehmigungsausweises Nr. 40029577.
This supplement is only valid in conjunction with page 1 of the Certificate No. 40029577.

Gerätesteckdose, nicht-wiederanschließbar *Connector, non-rewirable*

Typ(en) / *Type(s)*:

- 1) YC-12
- 2) YC-12L

Bemessungsspannung <i>Rated voltage</i>	AC 250 V
Bemessungsstrom <i>Rated current</i>	10 A
Polzahl <i>Number of poles</i>	2-polig mit Schutzkontakt <i>2-pole with earthing contact</i>
Bauart <i>Kind of construction</i>	Normblatt C13 <i>standard sheet C13</i>
Warenzeicheninhaber <i>Trademark holder</i>	Yung Li Co. Ltd.
Produktinformation <i>Product information</i>	siehe Anlage Nr. 300 + 400 + 900 <i>see Appendix No. 300 + 400 + 900</i>
PAK	Das Produkt entspricht den Anforderungen gemäß PAK-Dokument ZEK 01.2-08.
PAH	<i>The product is in accordance with the requirements of PAH-document ZEK 01.2-08.</i>

Fortsetzung siehe Blatt 3 /
continued on page 3

VDE Prüf- und Zertifizierungsinstitut GmbH * Testing and Certification Institute



DEPARTMENT OF **FAIR TRADING**
NSW Consumer Protection Agency

Certificate Number: 17665

CERTIFICATE OF APPROVAL

ISSUED PURSUANT TO SECTION 21C OF THE ELECTRICITY SAFETY ACT 1945

ISSUED TO:

Yung Li Co Ltd

CLASS OF ARTICLE:

Appliance Connector

DESCRIPTION OF ARTICLE:

Appliance Connector
(Side-entry, C13 appliance connector, for cold conditions, for Class I equipment,
integrally moulded to any <HAR> certified H05VV-F 3G1.0mm², or Australian
approved three-core 1.00 mm², PVC insulated and sheathed ordinary duty
circular flexible cord)
Trade Name: 'Yung Li'
250V, ac, 10A

EXAMINED FOR COMPLIANCE WITH: AS/NZS 3109.1 : 1996 A1

TYPE REFERENCE CODE: Model No. YC-12L

APPROVAL MARK:

Each electrical article of the abovementioned type shall be marked with Approval Number
N17665

DATE OF APPROVAL: 30 April 2001

This approval expires 30 April 2006 unless suspended, cancelled, renewed or extended.

for DIRECTOR-GENERAL

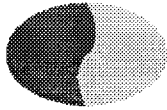

Ref: N17665/1

DEPARTMENT OF **FAIR TRADING**
NSW Consumer Protection Agency

ADDENDUM TO CERTIFICATE OF APPROVAL No 17665

Particulars of Modification(s)

Original Model No. YC-12L alternatively moulded to any <HAR> certified H05VV-F 3G0.75mm², or Australian approved three-core, 0.75mm², PVC insulated and sheathed ordinary duty circular flexible cord not exceeding two metres in length.

Approved: 30 April 2001

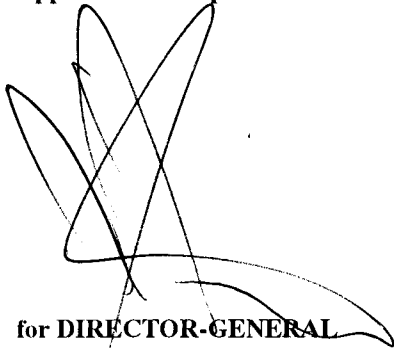

for DIRECTOR-GENERAL

Ref: 17665/2

ADDENDUM TO CERTIFICATE OF APPROVAL 17665

Particulars of Modification(s)

1. **Model No. YC-12L alternatively moulded to any <HAR> certified H05VV-F 3G1.5mm² or equivalent Australian approved three-core, 1.5mm², PVC insulated and sheathed ordinary duty circular flexible cord.**
2. **General Modification:
Model No. YC-12L now complies with AS/NZS 60320.1 : 2004.**

Approved: 21 March 2006



for Commissioner for Fair Trading

Ref: 17665/3

RENEWAL OF CERTIFICATE OF APPROVAL 17665

PARTICULARS OF RENEWAL

The approval of Appliance Connector Model No. YC-12L and approved modifications has been renewed for a period of FIVE years.

Date of Renewal: 27 April 2006

The Approval expires on 30 April 2011 unless it is renewed, extended, suspended or cancelled.

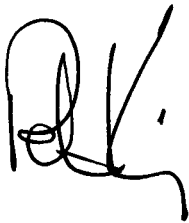
A handwritten signature in black ink, consisting of a large, stylized 'R' followed by a 'K' and a horizontal line extending to the right.

for Commissioner for Fair Trading

Ref: NSW17665/4

RENEWAL OF CERTIFICATE OF APPROVAL NSW17665

PARTICULARS OF RENEWAL

The approval of Appliance Connector Model No. YC-12L and approved modifications has been renewed for a period of FIVE years.

The Approval expires on 30/04/2016 unless it is renewed, extended, suspended or cancelled.



for Deputy Commissioner, Fair Trading Operations



Fair
Trading

Ref: NSW17665/5

RENEWAL OF CERTIFICATE OF APPROVAL: NSW17665

Particulars of Renewal

The approval of Appliance Connector Model No. YC-12L and approved modifications has been renewed for a period of FIVE years.

The Approval expires on 30/04/2021 unless it is renewed, extended, suspended or cancelled.

For Commissioner for Fair Trading

ZEICHENGENEHMIGUNG MARKS APPROVAL

Yung-Li Co. Ltd.
Da Pu Industrial Zone, Cang Zi
Chang Ping Town
523571 DONG GUAN CITY
Guangdong
CHINA

ist berechtigt, für ihr Produkt /
is authorized to use for their product

Starkstromleitungen für allgemeine Anwendungen
- Flexible Leitungen
mit thermoplastischer PVC-Isolierung
Cables for general applications
- *Flexible cables with*
thermoplastic PVC insulation

die hier abgebildeten markenrechtlich geschützten Zeichen
für die ab Blatt 2 aufgeführten Typen zu benutzen /
the legally protected Marks as shown below for the types referred to on page 2 ff.



oder/or



oder/or



Geprüft und zertifiziert nach /
Tested and certified according to

DIN EN 50525-2-11 (VDE 0285-525-2-11):2012-01; EN 50525-2-11:2011



VDE Prüf- und Zertifizierungsinstitut GmbH
VDE Testing and Certification Institute
Zertifizierungsstelle / *Certification*

K. Prohaska

VDE Zertifikate sind nur gültig bei Veröffentlichung unter:
VDE certificates are valid only when published on:

Aktenzeichen: 1609800-5140-0005 / 171941
File ref.:

Ausweis-Nr. 40010145 Blatt 1
Certificate No. Page

Weitere Bedingungen siehe Rückseite und Folgeblätter /
further conditions see overleaf and following pages

Offenbach, 2004-04-27
(letzte Änderung/updated 2012-09-25)

<http://www.vde.com/zertifikat>
<http://www.vde.com/certificate>

Name und Sitz des Genehmigungs-Inhabers / *Name and registered seat of the Certificate holder*
Yung-Li Co. Ltd., Da Pu Industrial Zone, Cang Zi, Chang Ping Town, 523571 DONG GUAN CITY,
Guangdong, CHINA

Aktenzeichen / *File ref.*
1609800-5140-0005 / 171941 / FG42 / HEG

letzte Änderung / *updated* Datum / *Date*
2012-09-25 2004-04-27

Dieses Blatt gilt nur in Verbindung mit Blatt 1 des Zeichengenehmigungsausweises Nr. 40010145
This supplement is only valid in conjunction with page 1 of the Certificate No. 40010145.

Starkstromleitungen für allgemeine Anwendungen
- Flexible Leitungen
mit thermoplastischer PVC-Isolierung
Cables for general applications
- Flexible cables with
thermoplastic PVC insulation

Typ(en) / *Type(s)*:

H03VV-F 2...4 x 0,5...0,75 mm ²	+
H03VVH2-F 2 x 0,5...0,75 mm ²	+
H05VV-F 2...5 x 0,75...4 mm ²	+
H05VVH2-F 2 x 0,75...1,0 mm ²	+

Leitungsbauart <i>Type of cable</i>	Standardleitungen <i>General purpose cables</i>
--	--

Firmenzeichen <i>Trademark</i>	YUNG LI
-----------------------------------	---------

Dieser Zeichengenehmigungs-Ausweis bildet eine Grundlage für die EG-Konformitätserklärung und CE-Kennzeichnung durch den Hersteller oder dessen Bevollmächtigten und bescheinigt die Konformität mit den grundlegenden Schutzanforderungen der **EG-Niederspannungsrichtlinie 2006/95/EG** mit ihren Änderungen.

This Marks Approval is a basis for the EC Declaration of Conformity and the CE Marking by the manufacturer or his agent and proves the conformity with the essential safety requirements of the EC Low-Voltage Directive 2006/95/EC including amendments.

VDE Prüf- und Zertifizierungsinstitut GmbH
VDE Testing and Certification Institute
Fachgebiet FG42
Section FG42

Name und Sitz des Genehmigungs-Inhabers / *Name and registered seat of the Certificate holder*
Yung-Li Co. Ltd., Da Pu Industrial Zone, Cang Zi, Chang Ping Town, 523571 DONG GUAN CITY,
Guangdong, CHINA

Aktenzeichen / *File ref.*
1609800-5140-0005 / 171941 / FG42 / HEG

letzte Änderung / *updated* Datum / *Date*
2012-09-25 2004-04-27

Dieses Beiblatt ist Bestandteil des Zeichengenehmigungsausweises Nr. 40010145.
This supplement is part of the Certificate No. 40010145.

Starkstromleitungen für allgemeine Anwendungen
- Flexible Leitungen
mit thermoplastischer PVC-Isolierung
Cables for general applications
- Flexible cables with
thermoplastic PVC insulation

Fertigungsstätte(n)
Place(s) of manufacture

Referenz/*Reference* Yung-Li Co. Ltd.
30008928 Da Pu Industrial Zone, Cang Zi
 Chang Ping Town
 523571 DONG GUAN CITY
 Guangdong
 CHINA

VDE Prüf- und Zertifizierungsinstitut GmbH
VDE Testing and Certification Institute
Fachgebiet FG42
Section FG42

Name und Sitz des Genehmigungs-Inhabers / *Name and registered seat of the Certificate holder*

Yung-Li Co. Ltd., Da Pu Industrial Zone, Cang Zi, Chang Ping Town, 523571 DONG GUAN CITY,
Guangdong, CHINA

Aktenzeichen / *File ref.*

1609800-5140-0005 / 171941 / FG42 / HEG

letzte Änderung / *updated* Datum / *Date*

2012-09-25

2004-04-27

Dieses Blatt gilt nur in Verbindung mit Blatt 1 des Zeichengenehmigungsausweises Nr. 40010145

This supplement is only valid in conjunction with page 1 of the Certificate No. 40010145.

Genehmigung zum Benutzen des auf Seite 1 abgebildeten markenrechtlich geschützten Zeichens des VDE:

Grundlage für die Benutzung sind die Allgemeinen Geschäftsbedingungen (AGB) der VDE Prüf- und Zertifizierungsinstitut GmbH (www.vde.com\AGB-Institut). Das Recht zur Benutzung erstreckt sich nur auf die bezeichnete Firma mit den genannten Fertigungsstätten und die oben aufgeführten Produkte mit den zugeordneten Bezeichnungen. Die Fertigungsstätte muss so eingerichtet sein, dass eine gleichmäßige Herstellung der geprüften und zertifizierten Ausführung gewährleistet ist.

Die Genehmigung ist so lange gültig wie die VDE-Bestimmungen gelten, die der Zertifizierung zugrunde gelegen haben, sofern sie nicht auf Grund anderer Bedingungen aus der VDE Prüf- und Zertifizierungsordnung (PM102) zurückgezogen werden muss.

Der Gültigkeitszeitraum einer VDE-GS-Zeichengenehmigung kann auf Antrag verlängert werden. Bei gesetzlichen und / oder normativen Änderungen kann die VDE-GS-Zeichengenehmigung ihre Gültigkeit zu einem früheren als dem angegebenen Datum verlieren.

Produkte, die das Biozid Dimethylfumarat (DMF) enthalten, dürfen gemäß der Kommissionsentscheidung 2009/251/EG nicht mehr in den Verkehr gebracht oder auf dem Markt bereitgestellt werden.

Der VDE-Zeichengenehmigungsausweis wird ausschließlich auf der ersten Seite unterzeichnet.

Approval to use the legally protected Mark of the VDE as shown on the first page:

Basis for the use are the general terms and conditions of the VDE Testing and Certification Institute (www.vde.com\terms-institute). The right to use the mark is granted only to the mentioned company with the named places of manufacture and the listed products with the related type references. The place of manufacture shall be equipped in a way that a constant manufacturing of the certified construction is assured.

The approval is valid as long as the VDE specifications are in force, on which the certification is based on, unless it is withdrawn according to the VDE Testing and Certification Procedure (PM102E).

The validity period of a VDE-GS-Mark Approval may be prolonged on request. In case of changes in legal and / or normative requirements, the validity period of a VDE-GS-Mark Approval may be shortened.

Products containing the biocide dimethylfumarate (DMF) may not be marketed or made available on the EC market according to the Commission Decision 2009/251/EC.

The approval is solely signed on the first page.