

東莞永力電業有限公司

YUNG LI CO., LTD

**Da Pu Industrial Zone, Gang Zi, Changping Town,
Dong Guan City, Guangdong 523571 China.P.R.C**

TEL:0769-83396797~8

FAX:0769-83396796

E-mail: sales@yung-li.com

Description: YP-03/YC-12

Customer : MAG

Parts No. : CB-N-CH-5M

Draw No. :

REVISION RECORD

1		
2		
3		
4		
5		

YUNG LI	
CHECKED	PREPARED BY

CUSTOMER	APPROVED

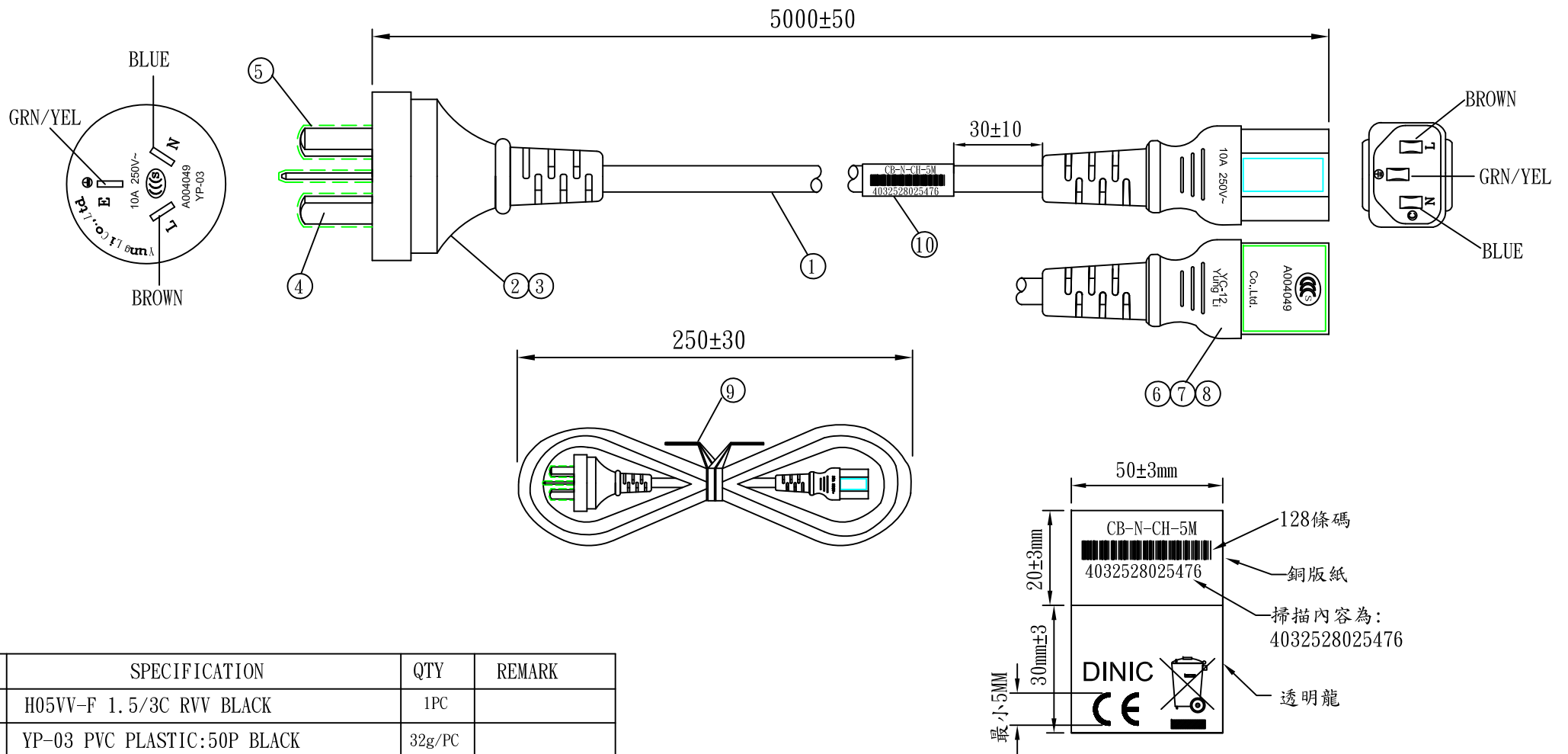

NO.	SPECIFICATION	QTY	REMARK
1	H05VV-F 1.5/3C RVV BLACK	1PC	
2	YP-03 PVC PLASTIC:50P BLACK	32g/PC	
3	YP-03 INNER BODY	1PC	
4	TER:98655LBS-1	3PCS	
5	SLEEVE:3PIN	1PC	
6	YC-12 PVC PLASTIC:50P BLACK	18g/PC	
7	YC-12 INNER BODY	1PC	
8	"U" TER:97740BS-0	3PCS	
9	MINI:L=200mm BLACK	1PC	
10	LABEL:(30+20)X50mm 128Code	1PC	Label-6771

Tolerance >0±0.30 >1.0±0.50 >10.0±1.0 >20.0±2.0 Angle: ±1°	Approved		Date		YUNG LI CO.,LTD			
	Checked		Date					
	Drawn	SUKI	Date	19.09.25	Customer	MAG		
	Cat. No.	YP-03/YC-12			P./N.	CB-N-CH-5M		
	Drawing No.	CY-C0127		Rev.	B	Material	P.V.C	Unit
					Scale			

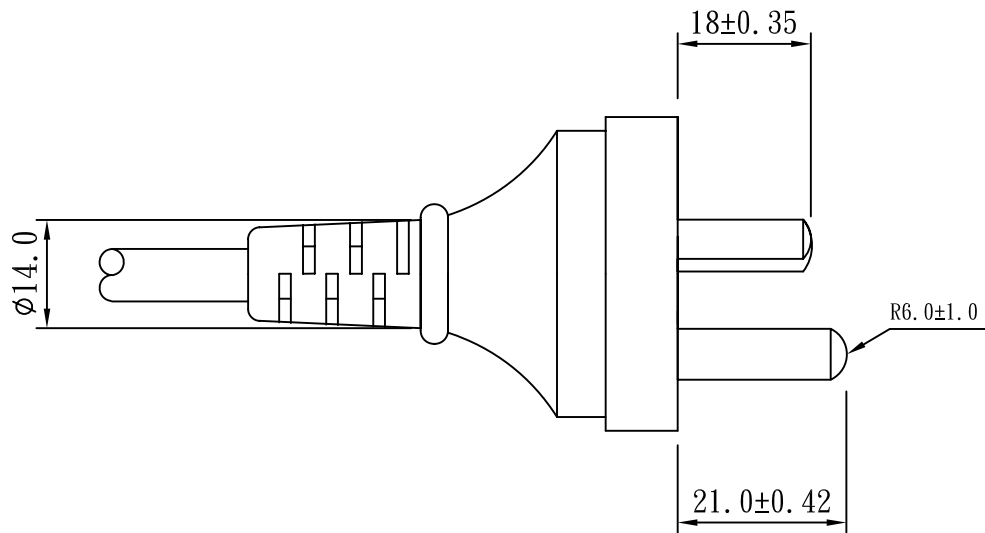
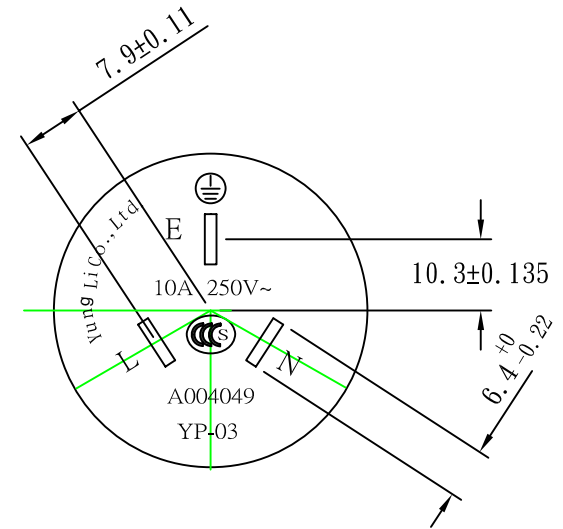
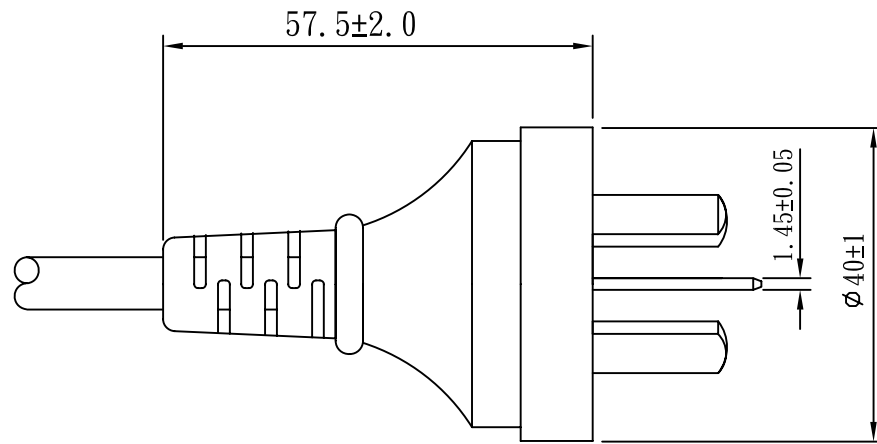

TOLERANCE >0±0.30 >1.0±0.50 >10.0±1.0 >20.0±2.0 Angle: ±1°	APPROVED	Robert	DATE	09.10.14	YUNG LI CO., LTD.			
	CHECKED		DATE					
	DRAWN	YUANJUN	DATE	09.10.14				
	TYPE	YP-03			P/N			
	DRAWING NO				MATERIAL	P.V.C	UNIT	mm
					SCALE	1:1		



IEC 60320 C13

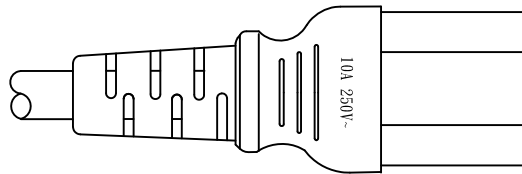
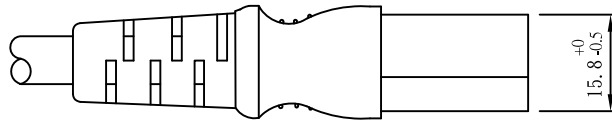
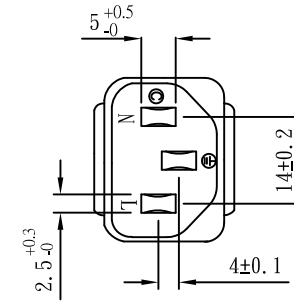
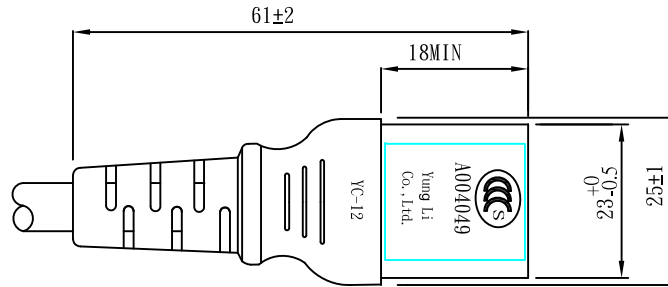

TOLERANCE >0±0.30 >1.0±0.50 >10.0±1.0 >20.0±2.0 Angle: ±1°	APPROVED		DATE		YUNG LI CO., LTD			
	CHECKED		DATE					
	DRAWN		DATE					
	TYPE	YC-12(CCC)			P/N			
	DRAWING NO.	D-C12BC	REV	B	SCALE	1:1	UNIT	mm

YUNG LI CO., LTD

SPECIFICATION

Yung Li	Style	PVC FLEXIBLE CORDS	Document No
2019.4.17			
Edition	Size	H05VV-F 3G 1.5mm²	Page
A			1/2







1. Standard: IEC 60227 IEC60228

2. Construction & Dimension

	Item	Specification
Conductor	Size	3G 1.5mm ²
	Material	Annealed Bare Copper
	Construction	48/ ϕ 0.202±0.01
Insulation	Material	PVC
	Minimum Average Thickness	0.70mm
	Minimum Thickness at any point	0.53mm
	Diameter	3.05± 0.10
	Identification	Blue,Brown,Green/Yellow
Core Assembly	Core Twist	3-Core
	Filler	NA
	Assembly Pair	NA
Taping	Mylar Foil	NA
Shielded	A1-Mylar Foil	NA
Drain	Material	NA
	Construction	NA
Jacket	Material	NA
	Minimum Average Thickness	0.9mm
	Minimum Thickness at any point	0.67mm
	Overall Diameter(Approx)	8.5± 0.15
	Color	Any colour

Marking:

Yung Li Co., Ltd. H05VV-F 3G 1.5mm² <VDE> NF-USE 1347  KEMA-KEUR  <OVE>

     IEMMEQU SAA-190646-EA  A004049 60227 IEC 53(RVV) 300/500V  SU01027-4002

YUNG LI CO., LTD

SPECIFICATION

Yung Li	Style	PVC FLEXIBLE CORDS	Document No
2019.4.17			
Edition	Size	H05VV-F 3G 1.5mm²	Page
A			2/2

4. Electrical & Physical Properties			
	Item	Specification	
	Rating Voltage	300/500V	
	Maximum Temperature Rating	70°C	
	Conductor resistance(AT 20°C)	13.3 Ω/Km Max	
	Insulation Resistance(AT 70°C)	0.010MΩ/Km Min	
	Dielectric Strength	AC 2.0 KV / 15MIN No Break	
	Spark Test	5KV	
Insulation	Unaged	Tensile Strength	1.02 kgf/mm ² min
		Elongation	150% Min
	Aged	Tensile Strength	80~120% (80°C x168hrs)
		Elongation	80~120% (80°C x168hrs)
	Loss of mass Test		2.0mg/cm ² (max)
Jacket	Unaged	Tensile Strength	1.02 kgf/mm ² min
		Elongation	150% Min
	Aged	Tensile Strength	80~120% (80°C x168hrs)
		Elongation	80~120% (80°C x168hrs)
	Loss of mass Test		2.0mg/cm ² (max)
Deformation Test		70±4°C X 1hr ≤ 50%	
Cold Bend Test		-15°C x 4hr No Crack	
Heat Shock Test		150±2°C x 1hr No Crack	

Graph:

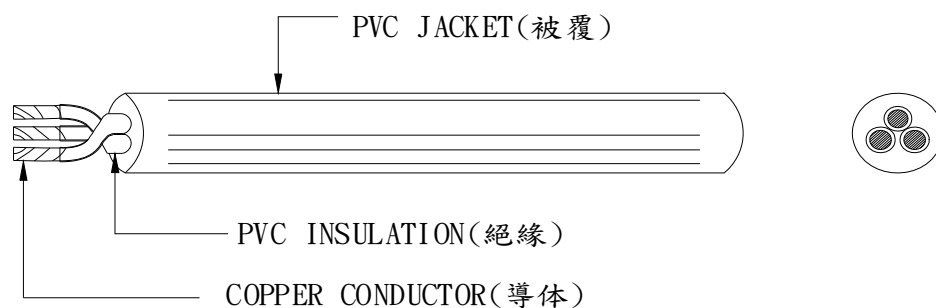



CERTIFICATE FOR CHINA COMPULSORY PRODUCT CERTIFICATION

No. : 2002010201011461

NAME AND ADDRESS OF THE APPLICANT

Yung Li Co., Ltd.
Dapu Industrial Zone, Gangzi, Changping Town, Dongguan

NAME AND ADDRESS OF THE MANUFACTURER

Yung Li Co., Ltd.
Dapu Industrial Zone, Gangzi, Changping Town, Dongguan

NAME AND ADDRESS OF THE FACTORY

Yung Li Co., Ltd.
Dapu Industrial Zone, Gangzi, Changping Town, Dongguan

NAME, MODEL AND SPECIFICATION

Single-phase Two-pole Non-rewirable Plug with Earthing-contact
YP-03、YP-03L 10A 250V~(配60227IEC53 3×0.75平方毫米;60227IEC53 3×1平方毫米;60227IEC53 3×1.5平方毫米)

THE STANDARDS AND TECHNICAL REQUIREMENTS FOR THE PRODUCTS

GB2099.1-2008;GB1002-2008

This is to certify that the above mentioned products have met the requirements of implementation rules for compulsory certification(REF NO. CNCA-C02-01:2014).

Date of issue: Nov.14, 2014 Date of expiry: Nov.14, 2019

Validity of this certificate is subject to positive result of the regular follow up inspection by issuing certification body until the expiry date.

Date of original certification: Aug.21, 2002

This certificate can be verified through CNCA's website: www.cnca.gov.cn



President:

Wang Kejiao



CHINA QUALITY CERTIFICATION CENTRE

Section 9, No.188, Nansihuan Xilu, Beijing 100070 P.R.China

<http://www.cqc.com.cn>



CERTIFICATE FOR CHINA COMPULSORY PRODUCT CERTIFICATION

CERTIFICATE NO.: 2002010204005923

NAME AND ADDRESS OF THE APPLICANT

Yung Li Co.,Ltd.

Dapu Industrial Zone, Gangzi, Changping Town, Dongguan

NAME AND ADDRESS OF THE MANUFACTURER

Yung Li Co.,Ltd.

Dapu Industrial Zone, Gangzi, Changping Town, Dongguan

NAME AND ADDRESS OF THE FACTORY

Yung Li Co.,Ltd.

Dapu Industrial Zone, Gangzi, Changping Town, Dongguan

PRODUCT NAME, MODEL AND SPECIFICATION

10A 250V Connector for Class I Equipment for Cold Conditions

YC-12、YC-12L、YC-12L-1、YC-12L-2、YC-12L-3 10A 250V~(配 60227IEC53 3×0.75mm²,60227IEC53 3×1mm²,60227IEC53 3×1.5mm²)

THE STANDARDS AND TECHNICAL REQUIREMENTS FOR THE PRODUCTS

GB/T17465.1-2009

This is to certify that the above mentioned product(s) complies with the requirements of implementation rules for compulsory certification(REFNO.CNCA-C02-01:2014).

Valid from: Oct.10,2018

Valid until: Oct.10,2023

The validity of the certificate is subject to positive result of the regular follow up inspection by issuing certification body until the expiry date.

Date of original issued: Jun.26,2002

The certificate information is available through CNCA's website: www.cnca.gov.cn



President:

Wang Kejiao



CHINA QUALITY CERTIFICATION CENTRE

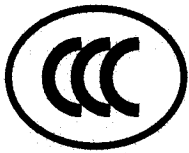

CERTIFICATE FOR CHINA COMPULSORY PRODUCT CERTIFICATION

No. : 2004010105138414

NAME AND ADDRESS OF THE APPLICANT

Yung Li Co., Ltd.
Dapu Industrial Zone, Gangzi, Changping Town, Dongguan

NAME AND ADDRESS OF THE MANUFACTURER

Yung Li Co., Ltd.
Dapu Industrial Zone, Gangzi, Changping Town, Dongguan

NAME AND ADDRESS OF THE FACTORY

Yung Li Co., Ltd.
Dapu Industrial Zone, Gangzi, Changping Town, Dongguan

NAME, MODEL AND SPECIFICATION

PVC insulated flexible cables and wires

60227 IEC 52(RVV) 300/300V 0.5-0.75(2-3芯); 60227 IEC 53(RVV) 300/500V
0.75-2.5(2-5芯);

THE STANDARDS AND TECHNICAL REQUIREMENTS FOR THE PRODUCTS

GB/T 5023.5-2008/IEC 60227-5:2003

This is to certify that the above mentioned products have met the requirements of implementation rules for compulsory certification(REF NO. CNCA-C01-01:2014).

Date of issue: Dec. 28, 2015 Date of expiry: Dec. 28, 2020

Validity of this certificate is subject to positive result of the regular follow up inspection by issuing certification body until the expiry date.

Date of original certification: Jan. 04, 2005

This certificate can be verified through CNCA's website: www.cnca.gov.cn



President:

Wang Kejiao

CHINA QUALITY CERTIFICATION CENTRE

Section 9, No.188, Nansihuan Xilu, Beijing 100070 P.R.China

<http://www.cqc.com.cn>

