

東莞永力電業有限公司

YUNG LI CO., LTD

**Da Pu Industrial Zone, Gang Zi, Changping Town,
Dong Guan City, Guangdong 523571 China.P.R.C**

TEL:0769-83396797~8

FAX:0769-83396796

E-mail: sales@yung-li.com

Description: **YP-22K/YC-14**

Customer: **MAG**

Parts No. : **CB-3-K0**

Draw No. :

REVISION RECORD

1		
2		
3		
4		
5		

YUNG LI	
CHECKED	PREPARED BY

CUSTOMER	APPROVED

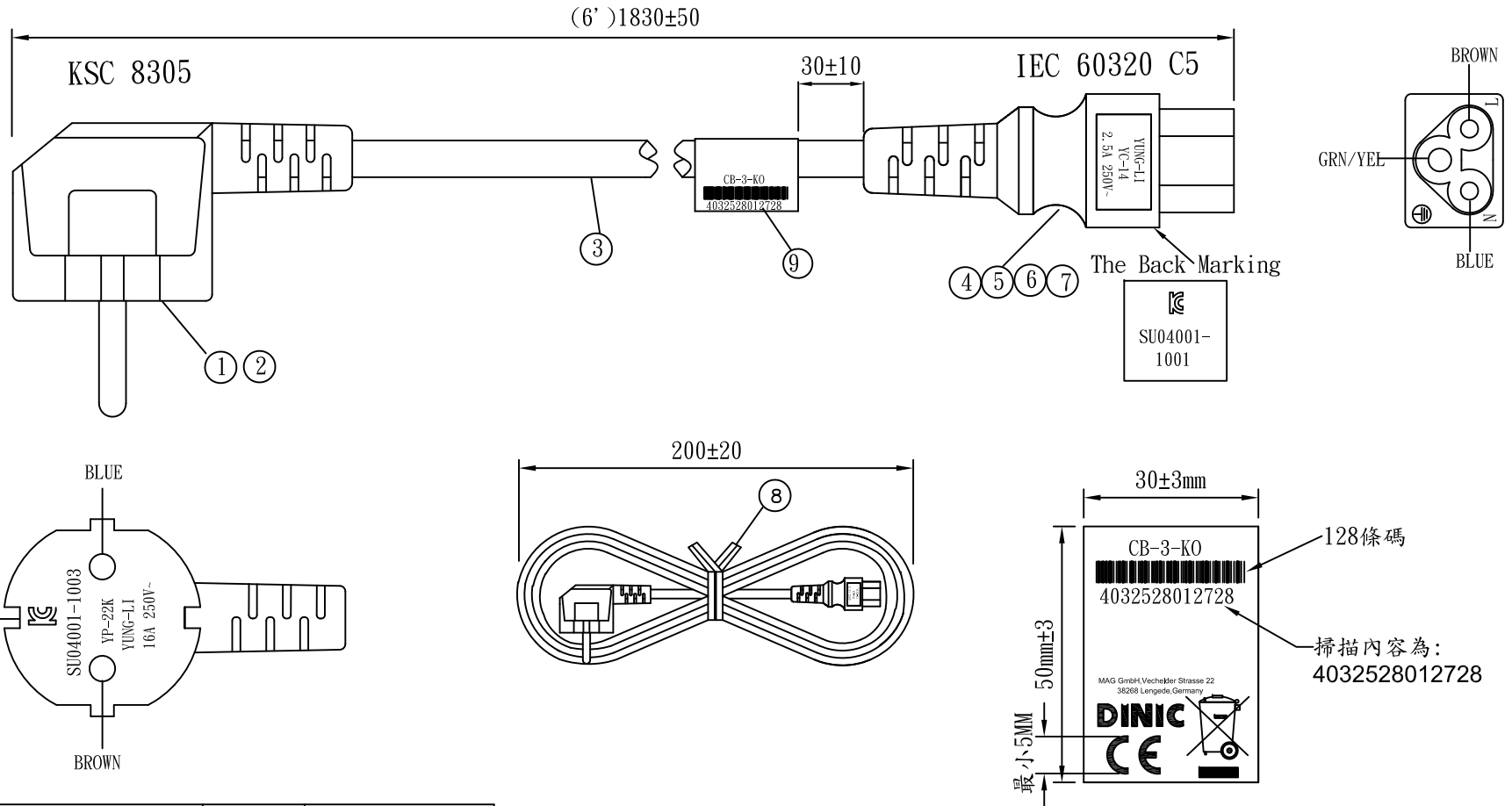

NO.	SPECIFICATION	QTY	REMARK
1	YP-22K PVC PLASTIC:50P BLACK	30g/PC	
2	KOREA FRAME	1PC	
3	H05VV-F 0.75/3C BLACK	1PC	
4	YC-14 PVC PLASTIC:50P BLACK	18g/PC	
5	TER:98714PS-0	2PCS	
6	TER:98732PS-0	1PC	
7	YC-14 H. S. G	1PC	
8	MINI TIE:L=130mm BLACK	1PC	
9	LABEL:50*30mm	1PC	

Tolerance >0±0.30 >1.0±0.50 >10.0±1.0 >20.0±2.0 Angle: ±1°	Approved		Date		YUNG LI CO., LTD.			
	Checked		Date					
	Drawn	SUKI	Date	22.08.19	Customer	MAG		
	Cat. No.	YP-22K/YC-14			P/N.	CB-3-KO		
	Drawing No.		Rev.	B	Material	P. V. C	Unit	mm
				Scale				

Sample Drawing NO. :
SP220819-07

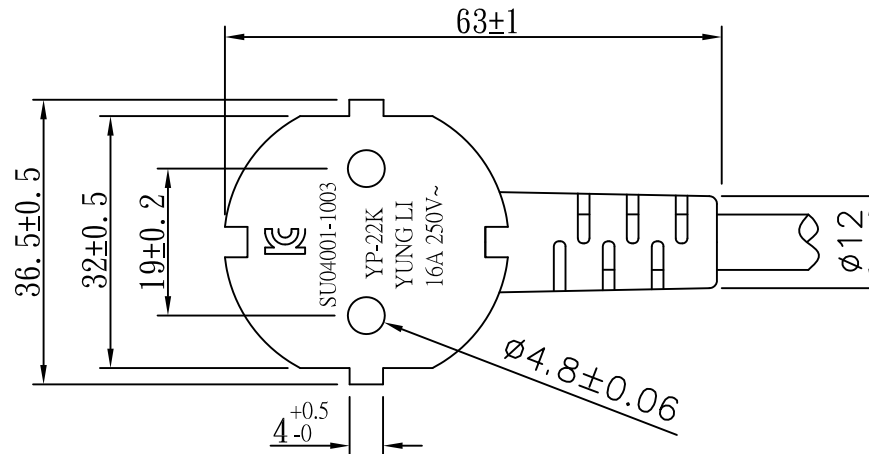
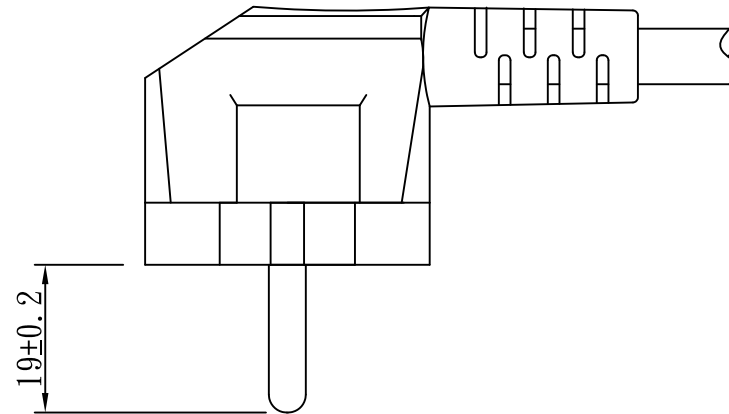
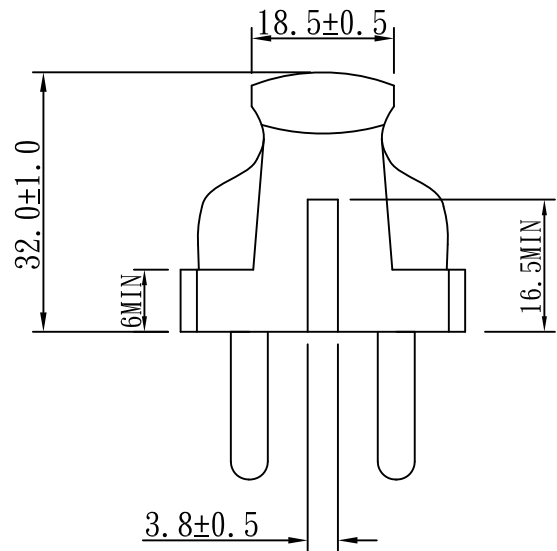

TOLERANCE >0±0.30 >1.0±0.50 >10.0±1.0 >20.0±2.0 Angle: ±1°	APPROVED		DATE		YUNG LI CO., LTD			
	CHECKED		DATE					
	DRAWN	黄方	DATE	10.8.30	CUSTOMER			
	TYPE	YP-22K			P/N			
	DRAWING NO.		REV	B	MATERIAL	P. V. C	UNIT	mm
				SCALE	1:1			

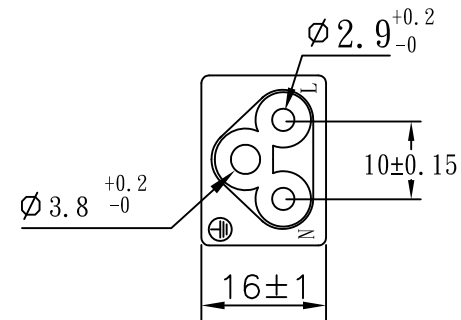
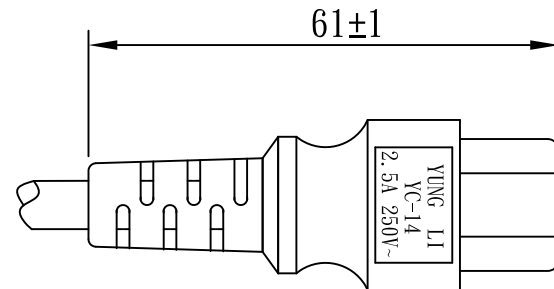
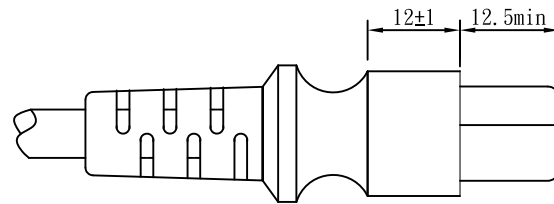
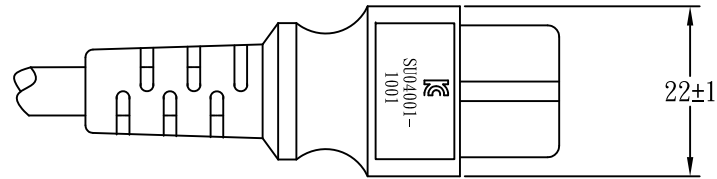
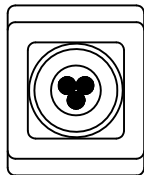

TOLERANCE >0±0.30 >1.0±0.50 >10.0±1.0 >20.0±2.0 Angle: ±1°	APPROVED		DATE	YUNG LI CO., LTD.			
	CHECKED		DATE				
	DRAWN		DATE				
	TYPE	YC-14		P/N			
	DRAWING NO			MATERIAL	P.V.C	UNIT	mm
				SCALE	1:1		

YUNG LI CO., LTD









SPECIFICATION

Yung Li	Style	PVC FLEXIBLE CORDS	Document No
2019.04.23			
Edition	Size	H05VV-F 3G 0.75mm²	Page
A			1/2

1. Standard: IEC 227 IEC228
 2. Construction & Dimension

	Item	Specification
Conductor	Size	3G 0.75mm ²
	Material	Annealed Bare Copper
	Construction	24/ § 0.202±0.05
Insulation	Material	PVC
	Minimum Average Thickness	0.60mm
	Minimum Thickness at any point	0.44mm
	Diameter	2.35 ± 0.10
	Identification	Blue,Brown,Green/Yellow
Core Assembly	Core Twist	3-Core
	Filler	NA
	Assembly Pair	NA
Taping	Mylar Foil	NA
Shielded	A1-Mylar Foil	NA
Drain	Material	NA
	Construction	NA
Jacket	Material	PVC
	Minimum Average Thickness	0.8mm
	Minimum Thickness at any point	0.58mm
	Overall Diameter(Approx)	6.7 ± 0.2
	Color	Any Color

Marking:

Yung Li Co., Ltd. H05VV-F 3G 0.75mm² <VDE> NF-USE 1347  KEMA-KEUR  CEBEC <OVE>
     IEMMEQU SAA-190646-EA  A004049 60227 IEC 53(RVV) 300/500V  SU01027-4002

YUNG LI CO., LTD

SPECIFICATION

Yung Li	Style	PVC FLEXIBLE CORDS	Document No
2019.04.23			
Edition	Size	H05VV-F 3G 0.75mm²	Page
A			2/2

4. Electrical & Physical Properties

Item	Specification		
Rating Voltage	70°C 300/500V		
Conductor resistance(AT 20°C)	26.0Ω/Km MAX		
Insulation Resistance(AT 70°C)	0.011MΩ/Km Min		
Dielectric Strength	AC 2.0 KV / 15 min No Break		
Spark Test	6.0KV		
Insulation	Unaged	Tensile Strength	1.02 kgf/mm ² min
		Elongation	150% Min
	Aged	Tensile Strength	80~120% (80°C x168hrs)
		Elongation	80~120% (80°C x168hrs)
	Loss of mass Test		2.0mg/cm ² (max)
	Jacket	Unaged	Tensile Strength
Elongation			150% Min
Aged		Tensile Strength	80~120% (80°C x168hrs)
		Elongation	80~120% (80°C x168hrs)
Loss of mass Test		2.0mg/cm ² (max)	
Deformation Test		70±2°C X 4hr ≤ 50%	
Cold Bend Test		-15°C x 1hr No Crack	
Heat Shock Test		150±2°C x 1hr No Crack	

Graph:

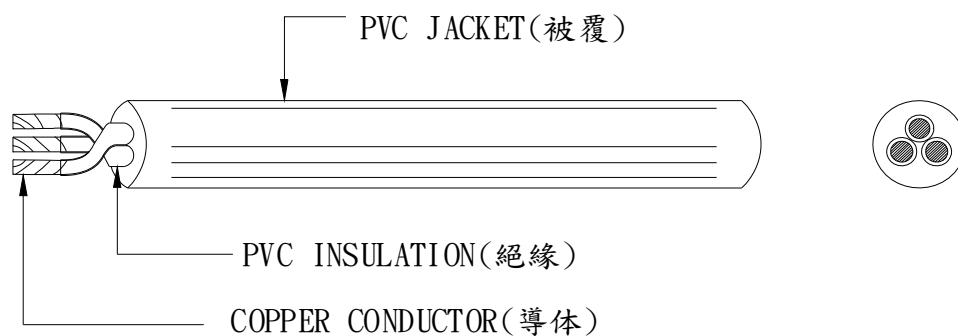

접수번호 : 17-080694-02-1
(Receipt No.)



안전인증서

Safety Certificate

안전인증번호 : SU01027-17002
(Certificate No.)

제조업자/수입업자명 : Yung Li Co.,Ltd
(Manufacturer/importer)

주소 : Da Pu Industrial Zone, Chang Ping Town, Dongguan City,
(Address) GuangDong Province China 523571

제품명 : 코드세트(Cord set)
(Product)

기본모델명 : YP-22K+YC-14
(Basic Model)

파생모델명 : YP-23K+YC-14
(Series Model)

정격/안전기준상의 모델구분 : 250 VAC 2.5 A
(Rating)

시험기준 : KC60799(2015-09)
(Standard)

본 인증서는 제조국명 : 중국
제조업자명 : Yung Li Co.,Ltd
제조공장의 주소 : Da Pu Industrial Zone, Chang Ping Town, Dongguan City, GuangDong Province China 523571
의 제품에만 해당함

「전기용품 및 생활용품 안전관리법 시행규칙」 제9조제2항·제4항 또는 제10조제2항에 따라 안전인증서를 발급합니다.

We Issue This Safety Certificate for the above appliances in accordance with the Article 9(2),9(4) or10 (2) of the Enforcement Rule of the Electrical Appliances and Consumer Products Safety Control Act.

2018 년 01 월 17 일
Year month day

한국산업기술시험원장

KOREA TESTING LABORATORY



* 이 인증서는 「전기용품 및 생활용품 안전관리법 시행규칙」에 따른 제품의 안전성 확인에 한정된 것이며, 그 밖의 다른 법률이 적용되는 제품의 경우에는 해당 법률에 따라 추가로 인증·허가 등을 받아야 합니다.

첨부서류	1. 전기용품의 안전관리부품 및 재질목록(List of Critical Components) 2. 기본모델·파생모델의 내용 (Descriptions of the basic and series model) 3. 안전인증의 변경 현황 (Revisions Status)
------	---

CERTIFICATE

OF SAFETY FOR ELECTRICAL APPLIANCES

Certification Number : SU01027-4002

Ref. No. : 04-1920-4372

Manufacturer's Name : Yung Li Co., Ltd.

& Address : Da Pu Industrial Zone, Chang Ping Town, Dongguan City,
GuangDong Province, China 523571

Factory Address : Same as Manufacturer's

Certified Product

1. Product : 코드류 (Polyvinyl chloride insulated cord)
2. Basic Model : 60227 IEC 53 (H05VV-F) 2Cx0.75mm²
3. Rating : 300/500V
4. Derivative Model : See the Attachment1

Applied Standard: K60227-5

Attached Supplement : 1. General Description of Certified Products

This is to certify that the product shown above is complied with the safety standards under the Electrical Appliance Safety Control Law, paragraph 2 of Article 5 and is manufactured by a scheme that follows continuous obligations of safety. The product listed above is eligible to bear the Korean Safety Mark.

Date of Issue: December 27, 2004



CERTIFICATION BODY

KOREA TESTING LABORATORY

Jong-Myung Lee / Certification Director

별첨 1: 파생모델구분 및 특기사항
 General description of Certified Products

파생모델명 Derivative model	기본모델과의 차이점 Differences between the basic and derivative model(s)
60227 IEC 53 (H05VV-F), 2Cx1.0~2.5 mm ²	Nominal sectional area
60227 IEC 53 (H05VV-F), 3Cx0.75~2.5 mm ²	Nominal sectional area & number of conductors
60227 IEC 53 (H05VVH2-F), 2x0.75 mm ²	Flat type
제품특기사항 및 시험조건 Remarks & Test conditions	
<p>1. Test Report No. : 04-1920-4372 (2004.12.23)</p> <p>2. Product Description</p> <ul style="list-style-type: none"> - "60227 IEC 53 (H05VV-F) 2Cx0.75 mm²" is rated nominal sectional area is 0.75 mm², constructed with 2 wires without ground wire, external figure is the flat type, sheathed with polyvinyl chloride - Permitted maximum using voltage between live and earth line & between live lines is AC300V/500V. - "60227 IEC 53 (H05VV-F) cord" means "sheathed flexible power cable insulated with polyvinyl chloride" & the external sheath figure is round circle. 	
<p><input type="checkbox"/> 본 제품의 시험내용에 관하여 문의하실 사항이 있으시면 아래 연락처로 문의하시기 바랍니다. 시험담당자 : 전기전자본부 신뢰성평가팀, 강호우 / (02)8601-415</p> <p><input type="checkbox"/> If you have any question on product testing, please contact the person below : Job holder : Electrotechnical Center Reliability Assessment Team, H.W.KANG/+82 2 8601-415</p>	

FP511-09-00