

東莞永力電業有限公司

YUNG LI CO., LTD

Da Pu Industrial Zone, Gang Zi, Changping Town,
Dong Guan City, Guangdong 523571 China.P.R.C

TEL:0769-83396797~8

FAX:0769-83396796

E-mail: sales@yung-li.com

Description: YP-12/YC-12

Customer: MAG

Parts No. : CB-N-J-SPE

Draw No. :

REVISION RECORD

1		
2		
3		
4		
5		

YUNG LI	
CHECKED	PREPARED BY

CUSTOMER	APPROVED

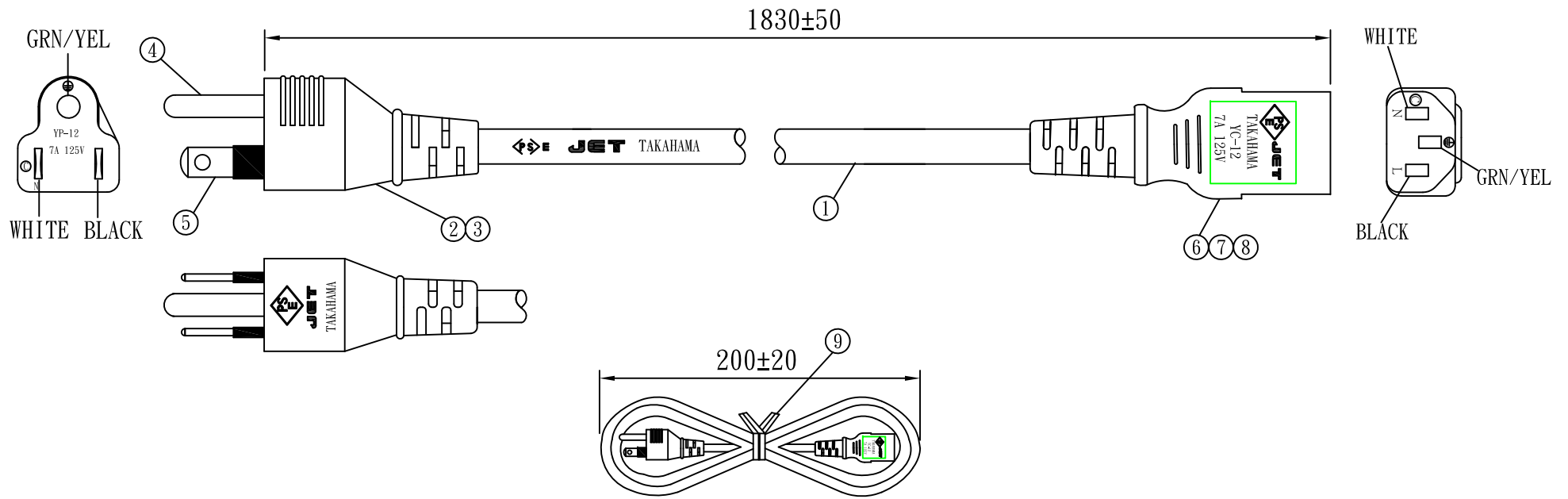

Sample Drawing NO.:
SP151208-03

NO.	SPECIFICATION	Q' TY	REMARK
1	PSE:VCTF 0.75/3 BLACK CONCAVE	1PC	
2	YP-12 PVC PLASTIC:50P BLACK	19g/PC	
3	YP-12 Inner body	1PC	
4	TER:98475	1PC	
5	TER:P98675BS-1B	2PCS	
6	YC-12 H. S. G	1PC	
7	YC-12 PVC PLASTIC:50P BLACK	18g/PC	
8	YC-12 TER:97740PS-0	3PCS	
9	MINI TIE:L=130mm BLACK	1PC	

CABLE MARKING:

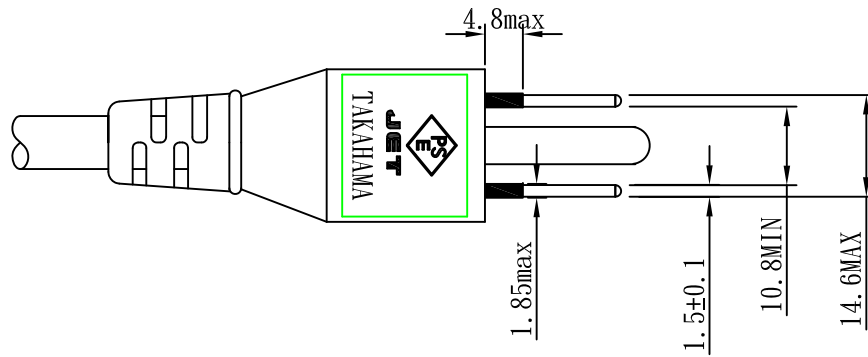
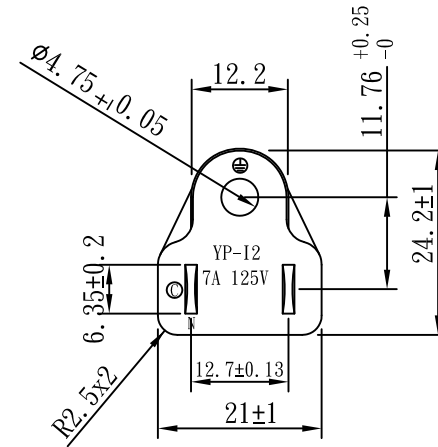
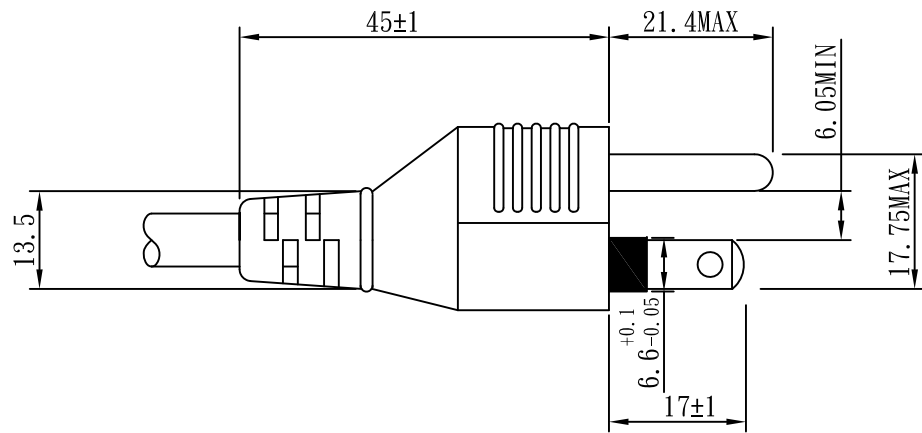

《P》 E JET TAKAHAMA VCTF 3G 0.75mm² 20XX -F-

Tolerance >0±0.30 >1.0±0.50 >10.0±1.0 >20.0±2.0 Angle: ±1°	Approved		Date		YUNG LI CO.,LTD			
	Checked		Date					
	Drawn	huangfang	Date	15.12.08	Customer	MAG		
	Cat. No.	PSE(YP-12/YC-12)			P/N.	CB-N-J-SPE		
	Drawing No.		Rev.	B	Material	P. V. C	Unit	mm
				Scale				

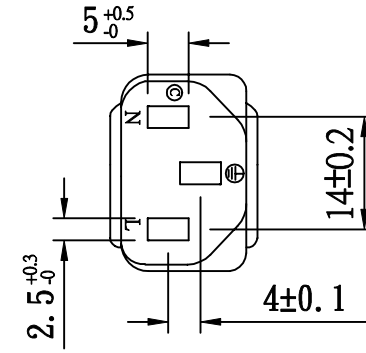
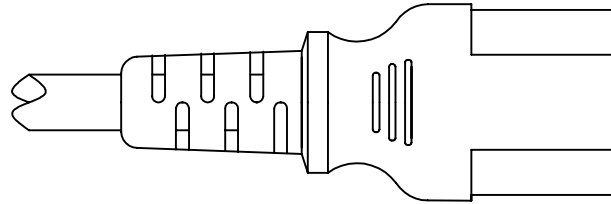
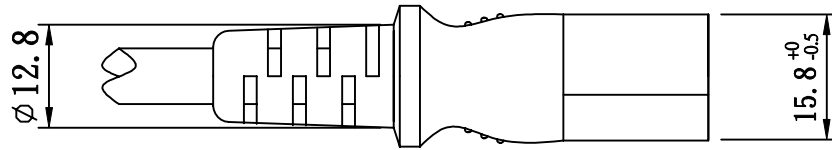
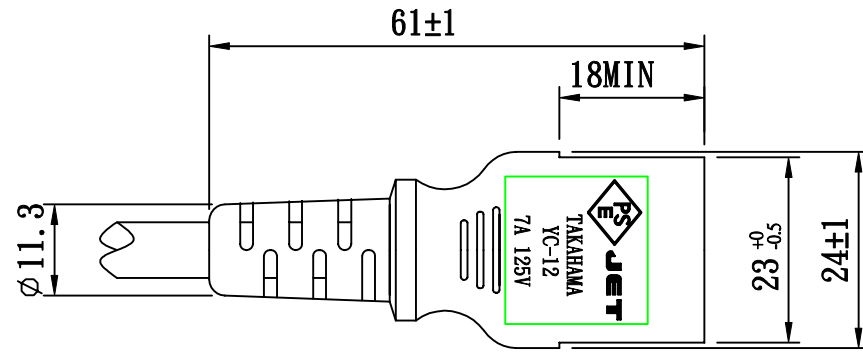

TOLERANCE >0±0.30 >1.0±0.50 >10.0±1.0 >20.0±2.0 Angle: ±1°	APPROVED		DATE		YUNG LI CO., LTD			
	CHECKED		DATE					
	DRAWN		DATE		CUSTOMER			
	TYPE	YP-12 (PSE)			P/N			
	DRAWING NO.		REV	B	MATERIAL	P. V. C	UNIT	mm
				SCALE	1:1			



TOLERANCE >0±0.30 >1.0±0.50 >10.0±1.0 >20.0±2.0 Angle: ±1°	APPROVED	YUNG LI CO., LTD					
	CHECKED						
	DRAWING BY	CUSTOMER					
	TYPE	YC-12(PSE)			P/N		
	DRAWING NO.	CY-C12PSE7A	REV	B	MATERIAL	P. V. C	UNIT
				SCALE	1:1	 	

YUNG LI CO., LTD

SPECIFICATION

Yung-Li	Style	PVC FLEXIBLE CORDS	Document No
2005.09.22			
Edition	Size	PSE VCTF 3G 0.75mm²	Page
A			1/2

1. Standard: JIS C3306
 2. Construction & Dimension

	Item	Specification
Conductor	Size	3G 0.75mm ²
	Material	Annealed Bare Copper
	Construction	30/ ϕ 0.18mm \pm 0.008
Insulation	Material	PVC
	Minimum Average Thickness	0.54mm
	Minimum Thickness at any point	0.48mm
	Diameter	2.35 \pm 0.10mm
	Identification	Black, White, Yellow/Green
Core Assembly	Core Twist	3-Core
	Filler	NA
	Assembly Pair	NA
Taping	Mylar Foil	NA
Shielded	A1-Mylar Foil	NA
Drain	Material	NA
	Construction	NA
Jacket	Material	PVC
	Minimum Average Thickness	0.9mm
	Minimum Thickness at any point	0.7mm
	Overall Diameter(Approx)	7.0 \pm 0.15mm
	Color	Any Color

Marking:

<PS> E JET TAKAHAMA VCTF 3G 0.75mm² 20XX -F-

YUNG LI CO., LTD

SPECIFICATION

Yung-Li	Style	PVC FLEXIBLE CORDS	Document No
2005.09.22			
Edition	Size	PSE VCTF 3G 0.75mm²	Page
A			2/2

3. Electrical & Physical Properties

Item	Specification		
Rating Voltage	300V		
Conductor resistance(AT 20°C)	25.1Ω/Km MAX		
Insulation Resistance(AT 20°C)	5.0MΩ/Km Min		
Dielectric Strength	AC 1.0 KV / 1min No Break		
Spark Test	5KV/0.15sec		
Insulation	Unaged	Tensile Strength	1.02 kgf/mm ² min
		Elongation	100% Min
	Aged	Tensile Strength	Min 85% (100°C x48hrs)
		Elongation	Min 80% (100°C x48hrs)
Jacket	Unaged	Tensile Strength	1.02 kgf/mm ² min
		Elongation	100% Min
	Aged	Tensile Strength	Min 85% (100°C x48hrs)
		Elongation	Min 80% (100°C x48hrs)
Deformation Test	120±3°C m X 1hr ≤ 50%		
Cold Bend Test	-10°C ± x 1hr No Crack		
Heat Shock Test	120±3°C x 1hr No Crack		

Graph:

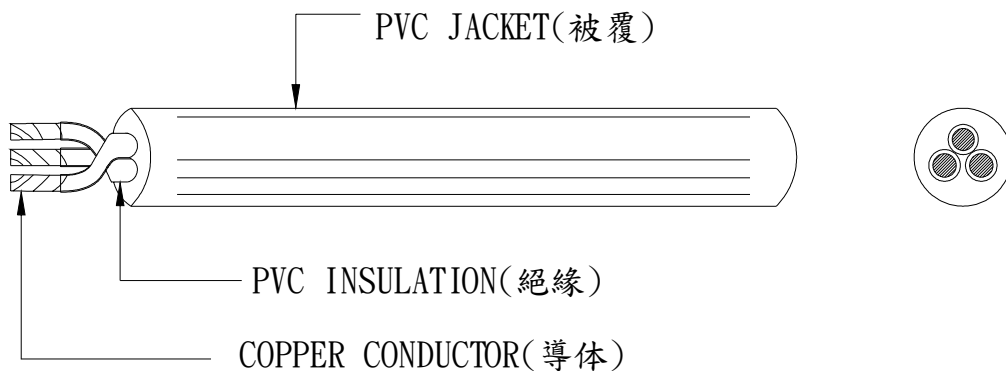

適 合 同 等 証 明 書

Statement of Conformity Assessment

電気用品安全法第8条第1項に規定する技術基準及び同法第9条第2項の経済産業省令で定める基準（法第9条第1項第2号に係る検査に係るものに限る）に適合していることを証明します

I hereby certify that the product mentioned below complies with the technical requirements stipulated in Paragraph 1 of Article 8 of Electrical Appliances and Materials Safety Act (here under referred to as the Act) and the requirements defined by the ordinance of the Ministry of Economy, Trade and Industry based on Paragraph 2 of Article 9 of the Act (limited to Item 2 of Paragraph 1 of Article 9 for Inspection of the Act).

1. 証明書番号： J E T 5 0 8 7 - 4 3 0 0 1 - 1 0 1 0
Statement Number
2. 交付年月日： 平成28年 8月26日
Effective Date August 26, 2016
3. 有効年月日： 平成35年 8月25日
Date of Validity August 25, 2023
4. 申込者名 (Applicant)
住所： DAPU INDUSTRIAL ZONE, GANGZI, CHANGPING TOWN,
DONGGUAN CITY, GUANGDONG PROVINCE, CHINA
Address

氏名又は名称： YUNG LI CO., LTD.
Name

5. 特定電気用品名： 差込みプラグ
Name of Product Attachment plugs
6. 型式の区分： 別紙のとおり
Type Classification See attached "Type Classification"
7. 製造工場名 (Manufacturer)
住所： DAPU INDUSTRIAL ZONE, GANGZI, CHANGPING TOWN,
DONGGUAN CITY, GUANGDONG PROVINCE, CHINA
Address

氏名又は名称： YUNG LI CO., LTD.
Name

8. 適用試験規格： 電気用品の技術上の基準を定める省令の解釈
Applied Standard for Testing Description of the technical requirements by the METI Ordinance
別表第四1、6及び別表第十 第5章
Appendix 4 Section 1, Section 6 and Appendix 10 Chapter 5

9. 適合性検査の方法： (Testing Method for Conformity Assessment)
 - 1) 試験用の特定電気用品については、電気用品の技術上の基準を定める省令の解釈に定める方法
With respect to testing for Category A products, the testing method is based on the technical requirements of the description of Electrical Appliances and Materials stipulated in the METI Ordinance.
 - 2) 当該特定電気用品に係る届出事業者又は事業場における検査設備については、電気用品安全法施行規則別表第四の検査設備の欄に掲げる検査設備ごとにそれぞれ同表の技術上の基準の欄に掲げる方法
With respect to inspection facilities required for Category A products at the factory, Testing Method described in the column of the technical requirements for each inspection facilities in the column of inspection facilities is shown in the Appendix 4 of Enforcement Regulations of the Act.

10. 注意事項

- 1) この適合同等証明書は、提出された試験用の電気用品に関して評価を行った上で交付したものであり、同一の型式の区分にある電気用品について電気用品安全法第8条1項に規定する技術基準適合確認の義務を履行したことを示すものではありません。

This Statement of Conformity Assessment, which is issued on the evaluation of the submitted test-use Electrical Appliances and Materials, does not signify that the Obligation to Comply with Requirements, which is prescribed at Paragraph 1 of Article 8 of the Act, is fulfilled on Electrical Appliances and Materials in the same Type Classification.

- 2) この適合同等証明書は、別紙に記載されている型式の区分の範囲内及び区分の組み合わせについてのみ有効です。

This Statement of Conformity Assessment is valid only for Electrical Appliances and Materials within the Type Classifications and their combination as stated in the attached "Type Classification".

一般財団法人 電気安全環境研究所
Japan Electrical Safety & Environment Technology Laboratories (JET)

理事長 薦田 康久
President Yasuhisa Komoda

東京都渋谷区代々木5-14-12
(5-14-12, Yoyogi, Shibuya-ku, Tokyo, Japan)

証明書番号 : J E T 5 0 8 7 - 4 3 0 0 1 - 1 0 1 0

適合同等証明書別紙

Statement of Conformity Assessment

型式の区分

Type Classification

要素 Factor	区分 Classification
定格電圧 Rated voltage	(1) 125V以下のもの 125V or less
定格電流 Rated current	(2) 3Aを超え7A以下のもの Exceeding 3A, and less than or equal to 7A
極の配置（別表第二の一aに掲げる寸法に適合するものの場合に限る。） Pole configuration (limited to those specified in sub-clause 1a of Appendix 2)	(3) IIのもの II
極の数（別表第二の一bに掲げる寸法に適合するものの場合に限る。） Number of poles (limited to those specified in sub-clause 1b of Appendix 2)	—
刃の取付けの方式 Blade fixing method	(1) 一体として成形されているもの Integrated type
主絶縁体の材料 Insulation materials	(1) 合成樹脂のもの Plastic
外郭の材料 Outer case materials	(2) 合成樹脂のもの Plastic
接続の方式 Connection method	(1) 差込み型のもの（ロックナット式のものを除く。） Plug-in type (excluding those with locking nuts)
防水構造 Type of waterproof	(3) 非防水型のもの Not treated with waterproof type

証明書番号：JET5087-43001-1010

適合同等証明書

Statement of Conformity Assessment

電気用品安全法第8条第1項に規定する技術基準及び同法第9条第2項の経済産業省令で定める基準（法第9条第1項第2号に係る検査に係るものに限る）に適合していることを証明します

I hereby certify that the product mentioned below complies with the technical requirements stipulated in Paragraph 1 of Article 8 of Electrical Appliances and Materials Safety Act (here under referred to as the Act) and the requirements defined by the ordinance of the Ministry of Economy, Trade and Industry based on Paragraph 2 of Article 9 of the Act (limited to Item 2 of Paragraph 1 of Article 9 for Inspection of the Act).

1. 証明書番号： J E T 5 0 8 7 - 4 3 0 0 4 - 1 0 0 3
Statement Number
2. 交付年月日： 平成28年 8月26日
Effective Date August 26, 2016
3. 有効年月日： 平成35年 8月25日
Date of Validity August 25, 2023
4. 申込者名 (Applicant)
住所 (Address) : DAPU INDUSTRIAL ZONE, GANGZI, CHANGPING TOWN,
DONGGUAN CITY, GUANGDONG PROVINCE, CHINA

氏名又は名称： YUNG LI CO., LTD.
Name

5. 特定電気用品名： コードコネクターボディ
Name of Product Cord connector bodies
6. 型式の区分： 別紙のとおり
Type Classification See attached "Type Classification"
7. 製造工場名 (Manufacturer)
住所 (Address) : DAPU INDUSTRIAL ZONE, GANGZI, CHANGPING TOWN,
DONGGUAN CITY, GUANGDONG PROVINCE, CHINA

氏名又は名称： YUNG LI CO., LTD.
Name

8. 適用試験規格： 電気用品の技術上の基準を定める省令の解釈
Applied Standard for Testing Description of the technical requirements by the METI Ordinance
別表第四1、6及び別表第十 第5章
Appendix 4 Section 1, Section 6 and Appendix 10 Chapter 5

9. 適合性検査の方法： (Testing Method for Conformity Assessment)
 - 1) 試験用の特定電気用品については、電気用品の技術上の基準を定める省令の解釈に定める方法
With respect to testing for Category A products, the testing method is based on the technical requirements of the description of Electrical Appliances and Materials stipulated in the METI Ordinance.
 - 2) 当該特定電気用品に係る届出事業者又は事業場における検査設備については、電気用品安全法施行規則別表第四の検査設備の欄に掲げる検査設備ごとにそれぞれ同表の技術上の基準の欄に掲げる方法
With respect to inspection facilities required for Category A products at the factory, Testing Method described in the column of the technical requirements for each inspection facilities in the column of inspection facilities is shown in the Appendix 4 of Enforcement Regulations of the Act.

10. 注意事項

- 1) この適合同等証明書は、提出された試験用の電気用品に関して評価を行った上で交付したものであり、同一の型式の区分にある電気用品について電気用品安全法第8条1項に規定する技術基準適合確認の義務を履行したことを示すものではありません。

This Statement of Conformity Assessment, which is issued on the evaluation of the submitted test-use Electrical Appliances and Materials, does not signify that the Obligation to Comply with Requirements, which is prescribed at Paragraph 1 of Article 8 of the Act, is fulfilled on Electrical Appliances and Materials in the same Type Classification.

- 2) この適合同等証明書は、別紙に記載されている型式の区分の範囲内及び区分の組み合わせについてのみ有効です。

This Statement of Conformity Assessment is valid only for Electrical Appliances and Materials within the Type Classifications and their combination as stated in the attached "Type Classification".

一般財団法人 電気安全環境研究所
Japan Electrical Safety & Environment Technology Laboratories (JET)

理事長 薦田 康久
President Yasuhisa Komoda

東京都渋谷区代々木5-14-12
(5-14-12, Yoyogi, Shibuya-ku, Tokyo, Japan)

証明書番号：JET5087-43004-1003

適合同等証明書別紙

Statement of Conformity Assessment

型式の区分

Type Classification

要素 Factor	区分 Classification
定格電圧 Rated voltage	(1) 125V以下のもの 125V or less
定格電流 Rated current	(2) 3Aを超え7A以下のもの Exceeding 3A, and less than or equal to 7A
極の配置（別表第二の一aに掲げる寸法に適合するものの場合に限る。） Pole configuration (limited to those specified in sub-clause 1a of Appendix 2)	—
極の数（別表第二の一bに掲げる寸法に適合するものの場合に限る。） Number of poles (limited to those specified in sub-clause 1b of Appendix 2)	(2) アース極を含めて3のもの Three including earth
接続の方式 Connection method	(1) 差込み型のもの（ロックナット式のものを除く。） Plug-in type (excluding those with locking nuts)
接続する電線の種類（一般固定配線用のものの場合に限る。） Type of cable or cord to be connected (limited to socket outlets)	—
主絶縁体の材料 Insulation materials	(1) 合成樹脂のもの Plastic
外郭の材料 Outer case materials	(2) 合成樹脂のもの Plastic
スイッチ Switch	(2) ないもの Without switch
種類（一般固定配線用のものの場合に限る。） Type (limited to socket outlets)	—
使用の方法（コンセントの場合に限る。） Method of use (limited to socket outlets)	—
電源との接続の方式（マルチタップの場合に限る。） Power supply terminals (limited to multiple socket-outlet (with cord or pins for power supply connections))	—
電線と器体との一体成形（コンセントの場合を除く。） Non-rewirable construction (except socket outlets)	(1) あるもの With non-rewirable construction
防水構造 Type of waterproof	(3) 非防水型のもの Not treated with waterproof type

証明書番号：JET5087-43004-1003

適合同等証明書

Statement of Conformity Assessment

電気用品安全法第8条第1項に規定する技術基準及び同法第9条第2項の経済産業省令で定める基準（法第9条第1項第2号に係る検査に係るものに限る）に適合していることを証明します

I hereby certify that the product mentioned below complies with the technical requirements stipulated in Paragraph 1 of Article 8 of Electrical Appliances and Materials Safety Act (here under referred to as the Act) and the requirements defined by the ordinance of the Ministry of Economy, Trade and Industry based on Paragraph 2 of Article 9 of the Act (limited to Item 2 of Paragraph 1 of Article 9 for Inspection of the Act).

1. 証明書番号: JET5087-12009-1001
Statement Number
2. 交付年月日: 2019年3月24日
Effective Date March 24, 2019
3. 有効年月日: 2026年3月23日
Date of Validity March 23, 2026
4. 申込者名 (Applicant)
住 所: DAPU INDUSTRIAL ZONE, GANGZI, CHANGPING TOWN,
Address DONGGUAN CITY, GUANGDONG PROVINCE, CHINA

氏名又は名称: YUNG LI CO., LTD.
Name
5. 特定電気用品名: キャブタイヤコード
Name of Product Sheathed flexible cords
6. 型式の区分: 別紙のとおり
Type Classification See attached "Type Classification"
7. 製造工場名 (Manufacturer)
住 所: DAPU INDUSTRIAL ZONE, GANGZI, CHANGPING TOWN,
Address DONGGUAN CITY, GUANGDONG PROVINCE, CHINA

氏名又は名称: YUNG LI CO., LTD.
Name
8. 適用試験規格: 電気用品の技術上の基準を定める省令の解釈
Applied Standard for Testing Description of the technical requirements by the METI Ordinance
別表第一(1), (6)及び(9)
Appendix 1 Section 1, (1), (6) and (9)
9. 適合性検査の方法: (Testing Method for Conformity Assessment)
 - 1) 試験用の特定電気用品については、電気用品の技術上の基準を定める省令の解釈に定める方法
With respect to testing for Category A products, the testing method is based on the technical requirements of the description of Electrical Appliances and Materials stipulated in the METI Ordinance.
 - 2) 当該特定電気用品に係る届出事業者又は事業場における検査設備については、電気用品安全法施行規則別表第四の検査設備の欄に掲げる検査設備ごとにそれぞれ同表の技術上の基準の欄に掲げる方法
With respect to inspection facilities required for Category A products at the factory, Testing Method described in the column of the technical requirements for each inspection facilities in the column of inspection facilities is shown in the Appendix 4 of Enforcement Regulations of the Act.

10. 注意事項

- 1) この適合同等証明書は、提出された試験用の電気用品に関して評価を行った上で交付したものであり、同一の型式の区分にある電気用品について電気用品安全法第8条1項に規定する技術基準適合確認の義務を履行したことを示すものではありません。

This Statement of Conformity Assessment, which is issued on the evaluation of the submitted test-use Electrical Appliances and Materials, does not signify that the Obligation to Comply with Requirements, which is prescribed at Paragraph 1 of Article 8 of the Act, is fulfilled on Electrical Appliances and Materials in the same Type Classification.

- 2) この適合同等証明書は、別紙に記載されている型式の区分の範囲内及び区分の組み合わせについてのみ有効です。

This Statement of Conformity Assessment is valid only for Electrical Appliances and Materials within the Type Classifications and their combination as stated in the attached "Type Classification".

一般財団法人 電気安全環境研究所
Japan Electrical Safety & Environment Technology Laboratories (JET)

理事長 薦田 康久
President Yasuhisa Komoda

東京都渋谷区代々木5-14-12
(5-14-12, Yoyogi, Shibuya-ku, Tokyo, Japan)

証明書番号 : J E T 5 0 8 7 - 1 2 0 0 9 - 1 0 0 1

適合同等証明書別紙

Statement of Conformity Assessment

型式の区分

Type Classification

要素 Factor	区分 Classification
絶縁体の主材料 Insulation materials	(1) ビニル混合物のもの Polyvinyl chloride
外装の主材料 Sheath materials	(1) ビニル混合物のもの Polyvinyl chloride
導体の種類 Conductor type	(1) A種のもの Type A
線心の構造 Core structure	(1) 同一のもの Same
耐震性 Vibration resistance	(2) ないもの Not vibration resistant
金属製の導体補強線 Metal messenger wires	(2) ないもの Without metal messenger wires

証明書番号 : J E T 5 0 8 7 - 1 2 0 0 9 - 1 0 0 1