

外箱標籤:每箱貼一張

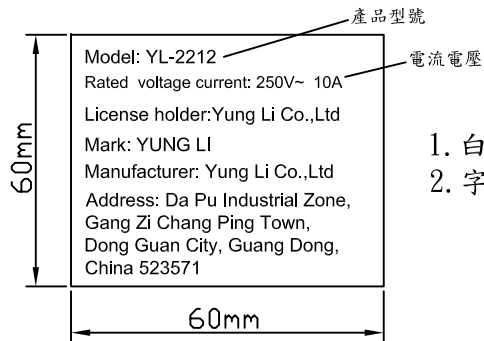

1. 白底黑字
2. 字體: Arial

- Note:
1. Rating: 10A 250V
 2. Insulation Resistance: 100MΩ
 3. Dielectric Voltage: 2000V/sec

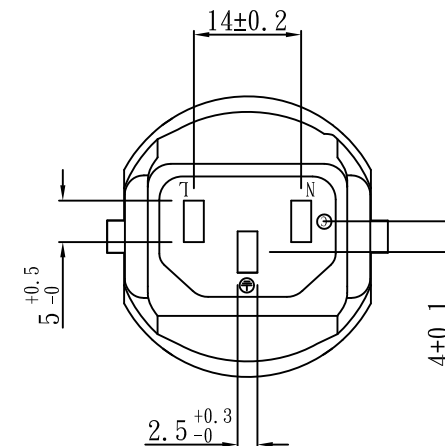
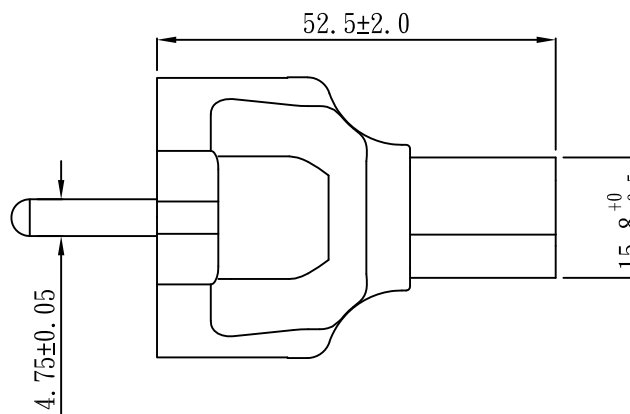
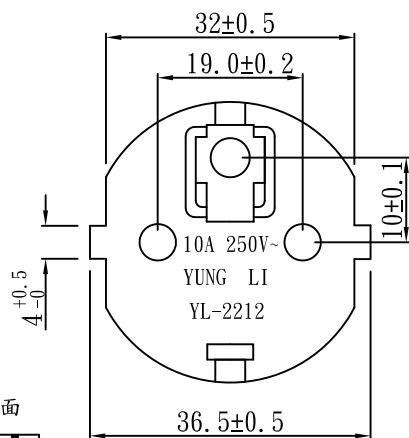
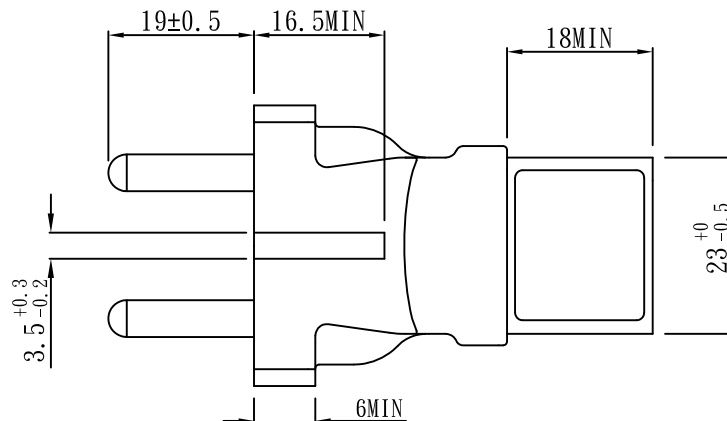

標籤貼在環保標誌的背面

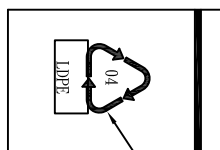

BLACK LOGO

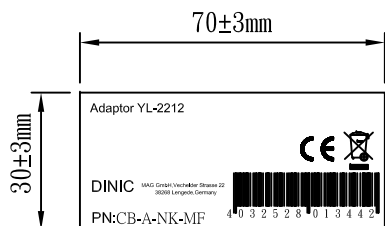

Tolerance >0±0.30 >1.0±0.50 >10.0±1.0 >20.0±2.0 Angle: ±1°	Approved		Date		YUNG LI CO., LTD.			
	Checked		Date					
	Drawn	SUKI	Date	21.01.21	Customer	MAG		
	Cat. No.	YL-2212			P/N.	CB-A-NK-MF		
	Drawing No.	CY-A2212-03	Rev.	B	Material	P.V.C	Unit	mm
				HEFT(g)				