

東莞永力電業有限公司

YUNG LI CO., LTD

**Da Pu Industrial Zone, Gang Zi, Changping Town,
Dong Guan City, Guangdong 523571 China.P.R.C**

TEL:0769-83396797~8

FAX:0769-83396796

E-mail: sales@yung-li.com

Description: YP-11/YC-13

Customer : MAG

Parts No. : CB-8-US

Draw No. :

REVISION RECORD

1		
2		
3		
4		
5		

YUNG LI	
CHECKED	PREPARED BY

CUSTOMER	APPROVED

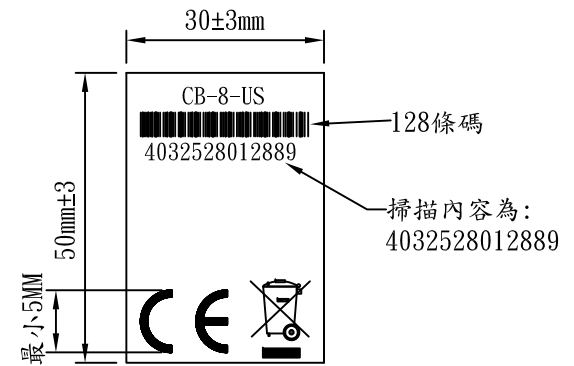
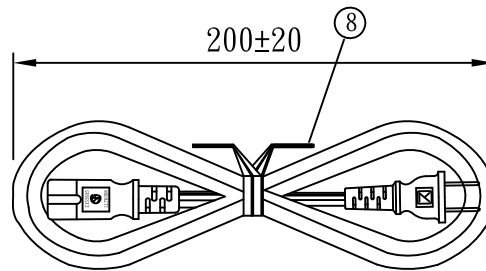
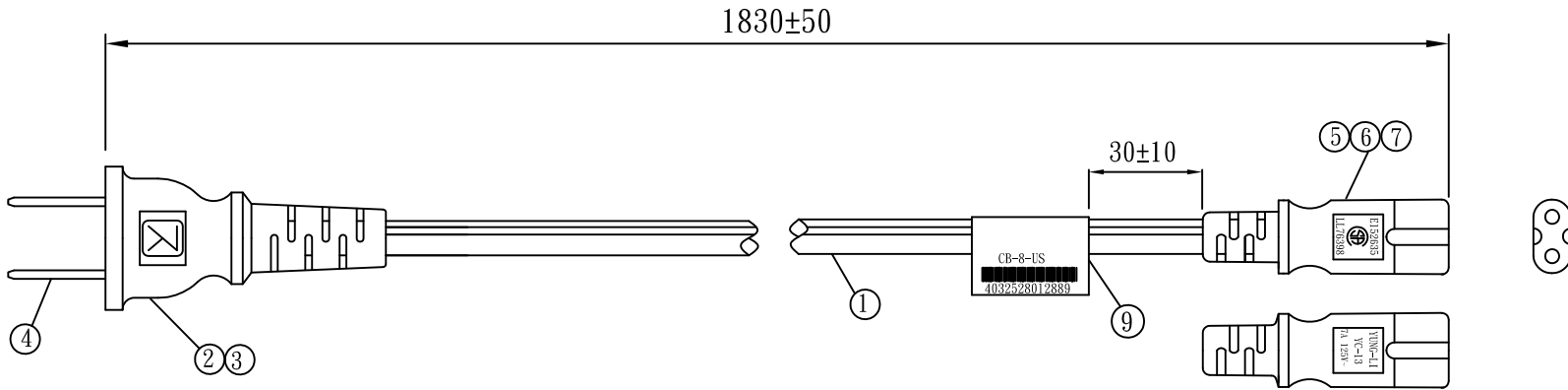

NO.	SPECIFICATION	QTY	REMARK
1	SPT-2 18/2C 105°C BLACK	1PC	
2	YP-11 INNER BODY	1PC	
3	YP-11 PVC PLASTIC:35P BLACK	15g/PC	
4	TER:98675BS-1/KDF 50T	2PCS	
5	YC-13 PVC PLASTIC:50P BLACK	9g/PC	
6	YC-13 H. S. G	1PC	
7	YC-13 TER	2PCS	
8	MINI TIE:L=110mm BLACK	1PC	
9	LABEL:50*30mm	1PC	

TOLERANCE >0±0.30 >1.0±0.50 >10.0±1.0 >20.0±2.0 Angle: ±1°	APPROVED		DATE		YUNG LI CO.,LTD			
	CHECKED		DATE					
	DRAWN	SUKI	DATE	19.12.06	CUSTOMER	MAG		
	TYPE	YP-11/YC-13			P/N	CB-8-US		
	DRAWING NO.	CY-U0003-46		REV	B	MATERIAL	P. V. C	UNIT
					SCALE			

NEMA 1-15P

認證號:

E152635

LR76393

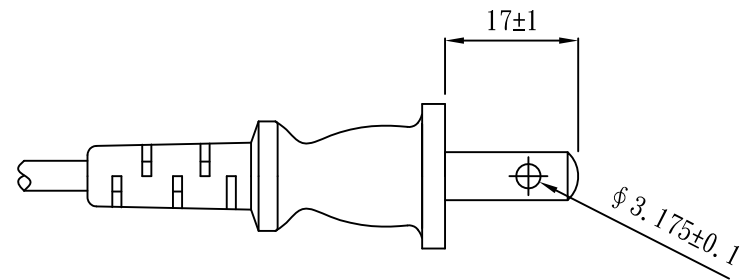
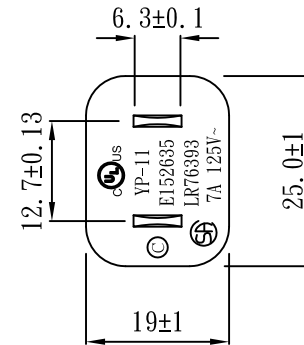
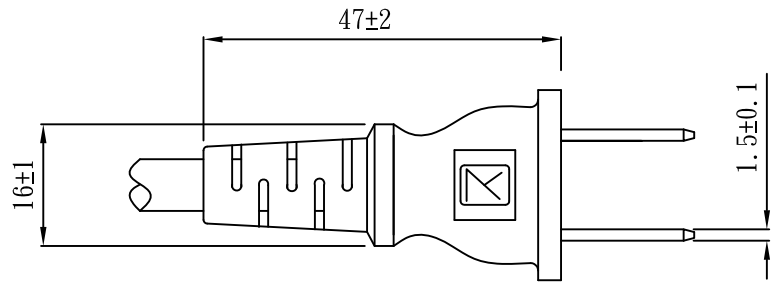

TOLERANCE >0±0.30 >1.0±0.50 >10.0±1.0 >20.0±2.0 Angle: ±1°	APPROVED		DATE		YUNG LI CO., LTD			
	CHECKED		DATE					
	DRAWN	Melon	DATE	19.05.17	CUSTOMER			
	TYPE	YP-11			P/N			
	DRAWING NO.		REV	B	MATERIAL	P. V. C	UNIT	mm
				SCALE	1:1			



IEC 60320 C7

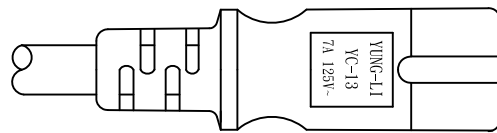
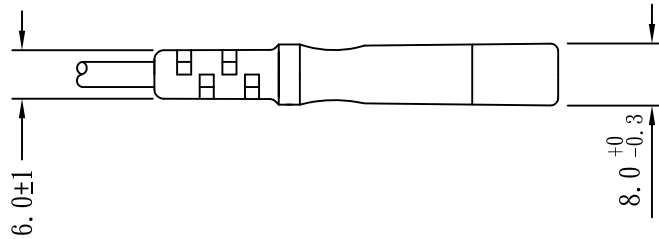
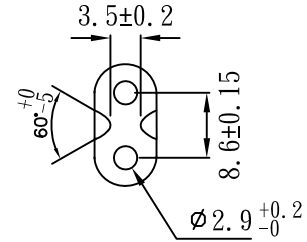
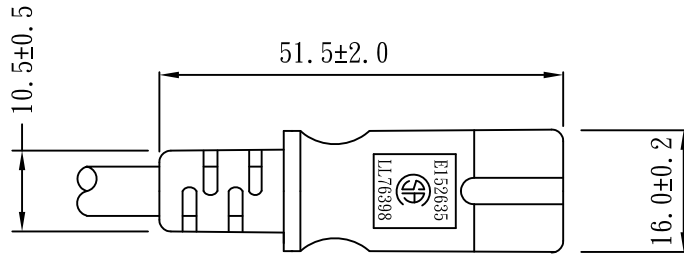

核准:	審核:	業務:	東莞永力電業有限公司 YUNG LI CO.,LTD				
一般寸法公差: >0±0.30 >1.0±0.50 >10.0±1.0 >20.0±2.0 Angle:±1°	制圖	黃海燕	日期	18.06.28	客戶		
	型號	YC-13(UL) 7A		版本	B	單重	
	圖號	MC-U13000		材質	P.V.C	單位	mm
	比例	1:1					

YUNG LI CO., LTD

SPECIFICATION

Yung-Li	Style	PVC FLEXIBLE CORDS	Document No
2007.5.22			
Edition	Size	SPT-2 18/2C 105	Page
A			1/2

1. Standard : UL 62 UL 1581

2. Construction & Dimension

	Item	Specification
Conductor	Size	18AWG X 2C
	Material	Annealed Bare Copper
	Construction	41/ 0.16±0.002
Insulation	Material	PVC
	Minimum Average Thickness	1.14mm
	Minimum Thickness at any point	1.02mm
	Diameter	6.8±0.2/3.4±0.1mm
	Identification	NA
Core Assembly	Core Twist	NA
	Filler	NA
	Assembly Pair	NA
Taping	Mylar Foil	NA
Shielded	A1-Mylar Foil	NA
Drain Wire	Material	NA
	Construction	NA
Jacket	Material	NA
	Minimum Average Thickness	NA
	Minimum Thickness at any point	NA
	Overall Diameter(Approx)	NA
	Color	Any Color

Marking :

YUNG LI (UL) E241374 SPT-2 2/C 18AWG(0.824mm²) 105 300V VW-1
 CSA 177323 SPT-2 2/C 18AWG(0.824mm²) 105 300V FT2

YUNG LI CO., LTD

SPECIFICATION

Yung-Li	Style	PVC FLEXIBLE CORDS	Document No
2007..5.22			
Edition	Size	SPT-2 18/2C 105	Page
A			2/2

3.Electrical & Physical Properties			
Item		Specification	
Rating Voltage		300V	
Insulation Resistance		0.76MΩ/Km 15.0 Min	
Dielectric Strength		AC 1.5 KV/1 min No Break	
Spark Test		6KV/0.15 sec	
Insulation	Unaged	Tensile Strength	1500psi Min
		Elongation	100% Min
	Aged	Tensile Strength	Min 85% (136±1 x 168hrs)
		Elongation	Min 65% (136±1 x 168hrs)
Jacket	Unaged	Tensile Strength	NA
		Elongation	NA
	Aged	Tensile Strength	NA
		Elongation	NA
Deformation Test		121±1 X 1hr 50%	
Cold Bend Test		-20 x 4hr No Crack	
Heat Shock Test		121±1 X 1hr No Crack	

Graph:

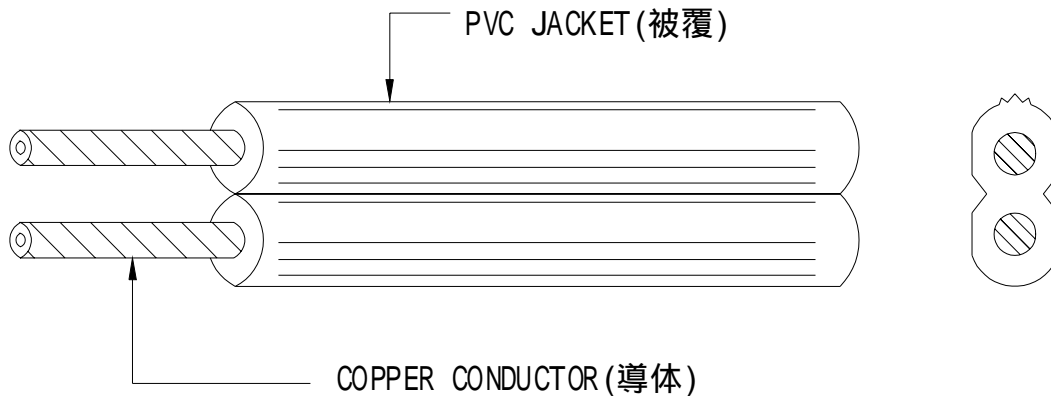

ELBZ7.E152635 - CORD SETS AND POWER-SUPPLY CORDS CERTIFIED FOR CANADA

Cord Sets and Power-supply Cords Certified for Canada

See General Information for Cord Sets and Power-supply Cords Certified for Canada

YUNG LI CO LTD

7F-12 NO 99 SEC 1 XINTAI 5TH RD
XIZHI DISTRICT
NEW TAIPEI, 22175 TAIWAN

Power-supply cords

E152635

Cat. No.	ANSI/NEMA Cord WD6 Config	AWG	Cord Type	Electrical Rating Amps V
YP-11	1-15	18/2	SPT-1, SPT-2, SPT-3, NISPT-2, SVT, SVTO, SJT, SJTW, SJTO, SJTOW (All TPE material), SPT-1, SPT-1W, NISPT-1, SPT-2, SPT-2W, NISPT-2, SPT-3, HPN, SVT, SVTO, SJT, SJTW, SJTO, SJTOW, SV, SVO, SJ, SJO, SJOW, SJOOW, EVT, EVJT, EVE, EVJE	7 or 10/125
		17/2	SVT, SVTO (All TPE material), SVT, SVTO, SV, SVO, SJ, SJO, SJOW, SJOOW, EVT, EVJT, EVE, EVJE	12/125
		16/2	SPT-2, SPT-3, NISPT-2, SVT, SVTO, SJT, SJTW, SJTO, SJTOW (All TPE material), SPT-2, SPT-2W, NISPT-2, SPT-3, SVT, SVTO, SJT, SJTW, SJTO, SJTOW, SV, SVO, SJ, SJO, SJOW, SJOOW, EVT, EVJT, EVE, EVJE	13/125
		16/2	HPN	15/125
		14/2	SPT-3, SJT, SJTW, SJTO, SJTOW (All TPE material), SPT-3, SJT, SJTW, SJTO, SJTOW, SJ, SJO, SJOW, SJOOW, EVT, EVJT, EVE, EVJE	15/125
YP-11W	1-15P	18/2	SPT-1, SPT-2, SPT-3, NISPT-2, SVT, SVTO, SJT, SJTW, SJTO, SJTOW (All TPE material), SPT-1, SPT-1W, NISPT-1, SPT-2, SPT-2W, NISPT-2, SPT-3, HPN, SVT, SVTO, SJT, SJTW, , SJTO, SJTOW, SV, SVO, SJ, SJO, SJOW, SJOOW, EVT, EVJT, EVE, EVJE	7 or 10/125
		17/2	SVT, SVTO (All TPE material), SVT, SVTO, SV, SVO, SJ, SJO, SJOW, SJOOW, EVT, EVJT, EVE, EVJE	12/125
		16/2	SPT-2, SPT-3, NISPT-2, SVT, SVTO, SJT, SJTW, SJTO, SJTOW (All TPE material), SPT-2, SPT-2W, NISPT-2, SPT-3, SVT, SVTO, SJT, SJTW, SJTO, SJTOW, SV, SVO, SJ, SJO, SJOW, SJOOW, EVT, EVJT, EVE, EVJE	13/125
		16/2	HPN	15/125
		14/2	SPT-3, SJT, SJTW, SJTO, SJTOW (All TPE material), SPT-3, SJT, SJTW, SJTO, SJTOW, SJ, SJO, SJOW, SJOOW, EVT, EVJT, EVE, EVJE	15/125

		15	SJT, SJTW, SJTO, SJTOW, ST, STW, STOW (Shielded and Non-shielded for all types), SPT-3 (All TPE material), SJT, SJTW, SJTO, SJTOW, ST, STW, STOW, SJ, SJO, SJOO, SJOW, SJOOW, SO, SOO, SOW, SOOW (Shielded or Non-shielded for above types), SPT-3	10, 14/125 or 250
		14	SJT, SJTW, SJTO, SJTOW, ST, STW, STOW (Shielded and Non-shielded for all types), SPT-3 (All TPE material), SJT, SJTW, SJTO, SJTOW, ST, STW, STOW, SJ, SJO, SJOO, SJOW, SJOOW, SO, SOO, SOW, SOOW (Shielded or Non-shielded for above types), SPT-3	15/125 or 250
		12	SJT, SJTW, SJTO, SJTOW, ST, STW, STOW (All TPE material, Shielded and Non-shielded for all types), SJT, SJTW, SJTO, SJTOW, ST, STW, STOW, SJ, SJO, SJOO, SJOW, SJOOW, SO, SOO, SOW, SOOW (Shielded or Non-shielded for all types)	15/125 or 250
YC-12(A.C.1)	IEC C13	12	SJT, SJTW, SJTO, SJTOW, ST, STW, STOW, SPT-3 (All TPE material), SJT, SJTW, SJTO, SJTOW, ST, STW, STOW, SO, SOW, SOOW, SPT-3	15/125 or 250
		10	SJT, SJTW, SJTO, SJTOW, ST, STW, STOW (All TPE material), SJT, SJTW, SJTO, SJTOW, ST, STW, STOW, SO, SOW, SOOW	15/125 or 250
YC-12C	IEC C13	18	NISPT-2 (TPE), NISPT-2	2.5, 7 or 10/125 or 250
		16	NISPT-2 (TPE), NISPT-2	13/125 or 250
YC-13	IEC C7	18	SPT-1, SPT-2, NISPT-2, SVT, SJT (All TPE material), SPT-1, SPT-1W, SPT-2, SPT-2W, NISPT-1, NISPT-2, SVT, SJT	2.5/250 or 7/125
YC-13W	IEC C7P	18	SPT-1, SPT-2, NISPT-2, SVT, SJT (All TPE material), SPT-1, SPT-1W, SPT-2, SPT-2W, NISPT-1, NISPT-2, SVT, SJT	2.5/250 or 7/125
YC-14	IEC C5	18	SPT-2, SVT, SVT shielded, SVTO, SJT, SJT shielded, SJTW, SJTW shielded, SJTO, SJTOW (All TPE material), SVT, SVT Shielded, SVTO, SJT, SJT Shielded, SJTW, SJTW Shielded, SJTO, SJTOW, SV, SVO, SJ, SJO, SJOW, SJOOW	2.5/250 or 7/125
			SPT-2	
YC-13L	IEC C7	18	SPT-1, SPT-2, NISPT-2, SVT, SJT (All TPE material), SPT-1, SPT-1W, SPT-2, SPT-2W, NISPT-1, NISPT-2, SVT, SJT	2.5/250 or 7/125
YC-13D	IEC C7	18	SPT-1, SPT-2, NISPT-2, SVT, SJT (All TPE material), SPT-1, SPT-1W, SPT-2, SPT-2W, NISPT-1, NISPT-2, SJT, SVT	2.5/250 or 7/125
YC-13C	IEC C7	18	NISPT-2 (All TPE material), NISPT-1, NISPT-2	2.5/250 or 7/125
YC-13E	IEC C7	18	SPT-1, SPT-2, NISPT-2, SVT, SJT (All TPE material), SPT-1, SPT-1W, SPT-2, SPT-2W, NISPT-1, NISPT-2, SVT, SJT	2.5/250 or 7/125



Certificate of Compliance

Certificate: 70057591

Master Contract: 177323

Project: 80003488

Date Issued: 2019-07-24

Issued To: Yung Li Company Ltd.
7F-12, NO.99, Sec.1
Xintai 5th Rd., Xizhi Dist
New Taipei City, ., 22175
Taiwan

Attention: Mr. W.T. Lai, President

The products listed below are eligible to bear the CSA Mark shown

Issued by: *Vivian Zhao*
Vivian Zhao



PRODUCTS

CLASS - C584103 - CORD SETS– Special-use Cord Sets

Cord sets consisting of the following plug caps and connector bodies moulded onto flexible cords as listed:

PART	Plug Cap Cat No.	Plug Cap Config.	Connector Cat No.	Connector Config.	Flexible Cord		Rating
					AWG	Type	
A	YP-11(N)	1-15P	YC-13(N), YC-13L(N)	(60320) C7	18/2	SPT-1(I&N), SPT-2(I&N)	7A, 125V
B	YP-11W(P)	1-15P	YC-13W(P)	(60320) C7 Polarized	18/2	SPT-1(I&N), SPT-2(I&N)	7A 125V

Legend: Suffix (N) denotes Non-polarized; Suffix (P) denotes Polarized;
(I&N) denotes Integral and Non-integral construction.



Certificate: 70057591
Project: 80003488

Master Contract: 177323
Date Issued: 2019-07-24

APPLICABLE REQUIREMENTS

- CAN/CSA- C22.2 No.21-14 - Cord Sets and Power Supply Cords
- CSA C22.2 No.60320-1-11 - Appliance Couplers For Household And Similar General Purposes
 - Part 1: General Requirements

**ZJCZ.E241374**
Flexible Cord[Page Bottom](#)

Flexible Cord[See General Information for Flexible Cord](#)**YUNG LI CO LTD**

E241374

7F-12 NO 99 SEC 1 XINTAI 5TH RD
XIZHI DISTRICT
NEW TAIPEI, 22175 TAIWAN**Decorative cord**, Type(s) SPT-1W, SPT-2W**Dryer and range cord**, Type(s) SRDT**Jacketed cord**, Type(s) S, SE, SE-HF, SJ, SJE, SJE-HF, SJO, SJOO, SJOOW, SJOW, SJT, SJT-B, SJTO, SJTOW, SJTW, SO, SOO, SOOW, SOW, ST, ST-B, STO, STOW, STW, SVE, SVE-HF, SVT, SVT-B, SVTO**Parallel cord**, Type(s) NISPE-1, NISPE-1-HF, NISPE-2, NISPE-2-HF, NISPT-1, NISPT-2, SPE-1, SPE-1-HF, SPE-2, SPE-2-HF, SPE-3, SPE-3-HF, SPT-1, SPT-2, SPT-3[Last Updated](#) on 2016-03-07

[Questions?](#)[Print this page](#)[Terms of Use](#)[Page Top](#)

◆ 2016 UL LLC

The appearance of a company's name or product in this database does not in itself assure that products so identified have been manufactured under UL's Follow-Up Service. Only those products bearing the UL Mark should be considered to be Certified and covered under UL's Follow-Up Service. Always look for the Mark on the product.

UL permits the reproduction of the material contained in the Online Certification Directory subject to the following conditions: 1. The Guide Information, Assemblies, Constructions, Designs, Systems, and/or Certifications (files) must be presented in their entirety and in a non-misleading manner, without any manipulation of the data (or drawings). 2. The statement "Reprinted from the Online Certifications Directory with permission from UL" must appear adjacent to the extracted material. In addition, the reprinted material must include a copyright notice in the following format: "© 2016 UL LLC".



Certificate of Compliance

Certificate: 1594794 (LL 76398)

Master Contract: 177323

Project: 2616524

Date Issued: April 3, 2013

Issued to: Yung Li Company Ltd.

1F No 10 Lane 235 Pao Chiao Rd
Hsin Tien City
Taipei Hsien,
Taiwan
Attention: Wendy Wu

The products listed below are eligible to bear the CSA Mark shown



Kim Nguyen

Issued by: Kim Nguyen, P. Eng.

PRODUCTS

CLASS 5831 01 - WIRES - Flexible Cord

Types SPT-1, NISPT-1, SPT-2, NISPT-2, SPT-3, SVT, SVTO, SJT, SJTW, SJTO, SJTOW, ST, STW, STO, STOW with PVC insulation and jacket, rated 60C, 75C, 90C and 105C, FT1, FT2, VW-1.

APPLICABLE REQUIREMENTS

CSA C22.2 No 49 - Flexible Cords and Cables