

東莞永力電業有限公司

YUNG LI CO., LTD

**Da Pu Industrial Zone, Gang Zi, Changping Town,
Dong Guan City, Guangdong 523571 China.P.R.C**

TEL:0769-83396797~8

FAX:0769-83396796

E-mail: sales@yung-li.com

Description: YP-46/YC-12

Customer : MAG

Parts No. :

Draw No. :

REVISION RECORD

1		
2		
3		
4		
5		

YUNG LI	
CHECKED	PREPARED BY

CUSTOMER	APPROVED



N/14877

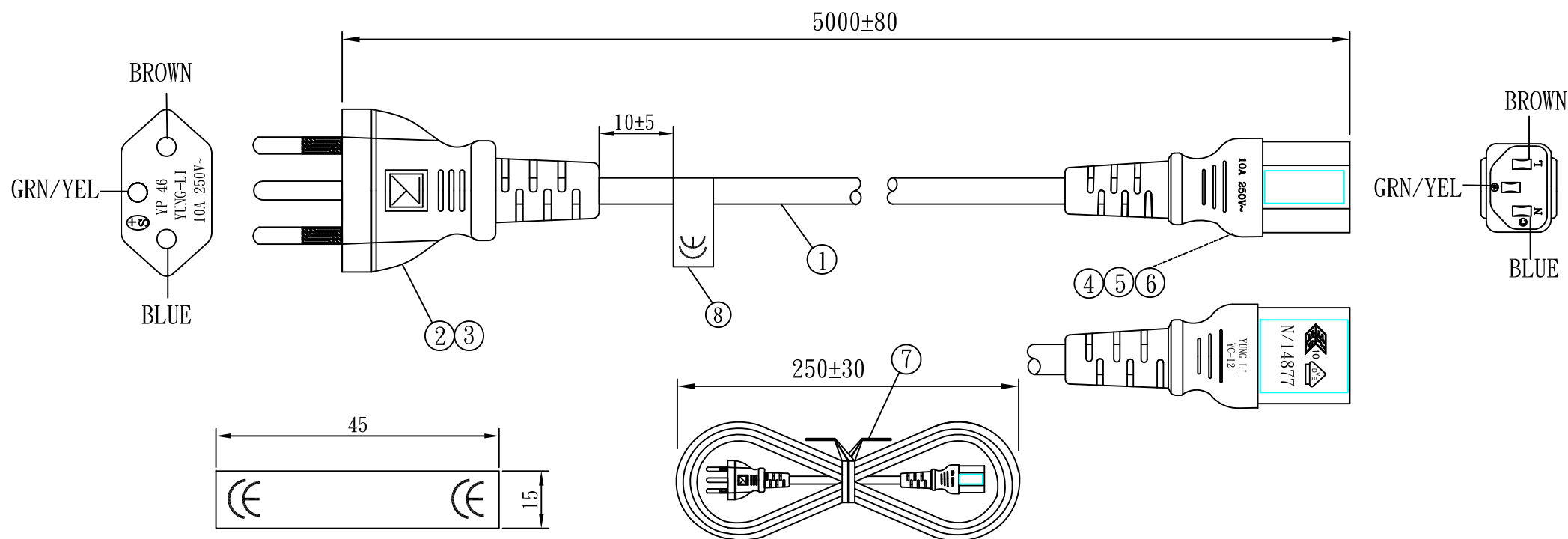



NO.	SPECIFICATION	Q' TY	REMARK
1	H05VV-F 1.0/3C BLACK	1PC	
2	YP-46 PVC PLASTIC:50P BLACK	18g/PC	
3	SWITZERLAND FRAME:P97005P BLACK	1PC	
4	YC-12 PVC PLASTIC:50P BLACK	18g/PC	
5	"U" TER:97740	3PCS	
6	YC-12 INNER BODY	1PC	
7	MINI TIE:L=180mm BLACK	1PC	
8	LABEL:45*15	1PC	

Tolerance >0±0.30 >1.0±0.50 >10.0±1.0 >20.0±2.0 Angle:	Approved		Date		YUNG LI CO., LTD.			
	Checked		Date					
	Drawn	SUKI	Date	15.04.27	Customer	MAG		
	Cat. No.	YP-46/YC-12			P/N.			
	Drawing No.		Rev.	B	Material	P.V.C	Unit	mm
				HEFT(g)				

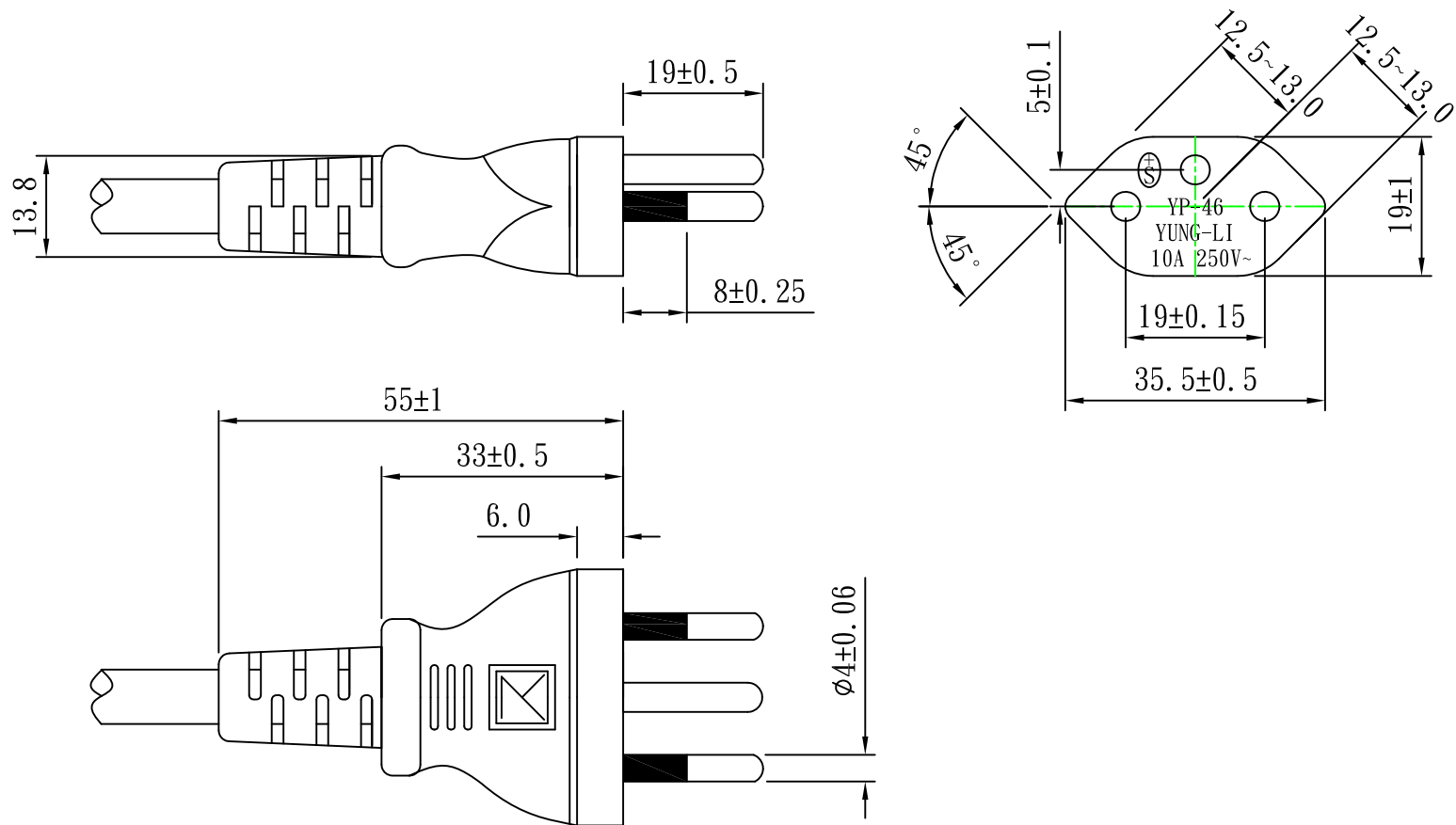
Sample Drawing NO.:
SP150427-07



Tolerance >0±0.30 >1.0±0.50 >10.0±1.0 >20.0±2.0 Angle: ±1°	Approved		Date		YUNG LI CO.,LTD			
	Checked		Date					
	Drawn		Date		Customer			
	Cat. No.	YP-46			P/N.			
	Drawing No.	CY-P46S	Rev.	B	Material	P. V. C	Unit	mm
					Scale			 



N/14877

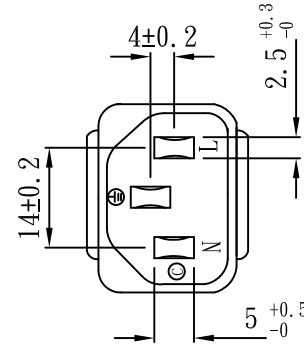
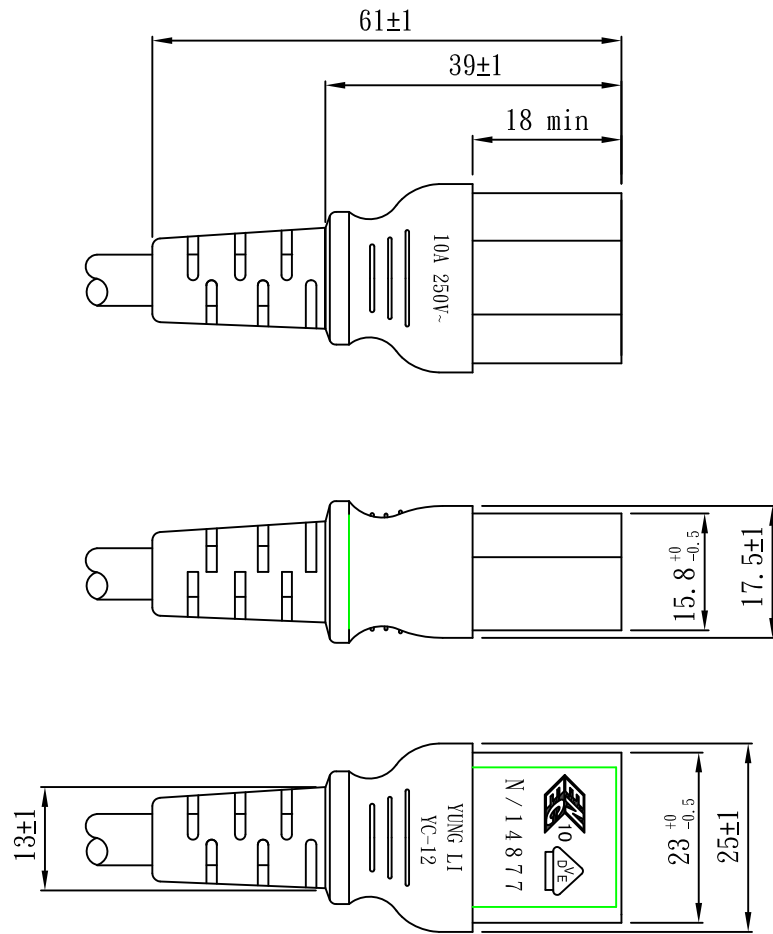

TOLERANCE >0±0.30 >1.0±0.50 >10.0±1.0 >20.0±2.0 Angle: ±1°	APPROVED		DATE		YUNG LI CO., LTD			
	CHECKED		DATE					
	DRAWN		DATE		CUSTOMER			
	TYPE	YC-12(ENEC)			P/N			
	DRAWING NO.	CY-C12V10A250VB	REV	B	MATERIAL	P. V. C	UNIT	mm
				SCALE	1:1			

YUNG LI CO., LTD

SPECIFICATION









Yung Li	Style	PVC FLEXIBLE CORDS	Document No
2012.7.18			YL-V01004
Edition	Size	H05VV-F 3G 1.0mm²	Page
A			1/2

1. Standard: IEC 60227 IEC 60228

2. Construction & Dimension

	Item	Specification
Conductor	Size	3G 1.0mm ²
	Material	Annealed Bare Copper
	Construction	32/ § 0.202±0.005
Insulation	Material	PVC
	Minimum Average Thickness	0.60mm
	Minimum Thickness at any point	0.48mm
	Diameter	2.50 ± 0.10
	Identification	Blue,Brown,Yellow/Green
Core Assembly	Core Twist	3-Core
	Filler	NA
	Assembly Pair	NA
Taping	Mylar Foil	NA
Shielded	A1-Mylar Foil	NA
Drain	Material	NA
	Construction	NA
Jacket	Material	NA
	Minimum Average Thickness	0.8mm
	Minimum Thickness at any point	0.58mm
	Overall Diameter(Approx)	7.0± 0.15
	Color	Any Color

Marking:

Yung Li Co., Ltd. H05VV-F 3G 1.0mm² <VDE> NF-USE 1347  KEMA-KEUR  CEBEC <ÖVE>
     IEMMEQU ES0140750  A004049 60227 IEC 53(RVV) 300/500V  SU01027-4002

YUNG LI CO., LTD

SPECIFICATION

Yung Li	Style	PVC FLEXIBLE CORDS	Document No
2012.7.18			YL--V01004
Edition	Size	H05VV-F 3G 1.0mm²	Page
A			2/2

4. Electrical & Physical Properties

Item	Specification		
Rating Voltage	300/500V		
Maximum Temperature Rating	70°C		
Conductor resistance(AT 20°C)	19.5Ω/Km MAX		
Insulation Resistance(AT 70°C)	0.010MΩ · Km Min		
Dielectric Strength	AC 2.0 KV / 15 min No Break		
Spark Test	5.0KV		
Insulation	Unaged	Tensile Strength	1.02 kgf/mm ² min
		Elongation	150% Min
	Aged	Tensile Strength	80~120% (80°C x 168hrs)
		Elongation	80~120% (80°C x 168hrs)
	Loss of mass Test		2.0mg/cm ² (max)
Jacket	Unaged	Tensile Strength	1.02 kgf/mm ² min
		Elongation	150% Min
	Aged	Tensile Strength	80~120% (80°C x 168hrs)
		Elongation	80~120% (80°C x 168hrs)
	Loss of mass Test		2.0mg/cm ² (max)
Deformation Test		70±4°C X 1hr ≤ 50%	
Cold Bend Test		-15°C x 4hr No Crack	
Heat Shock Test		150±2°C x 1hr No Crack	

Graph:

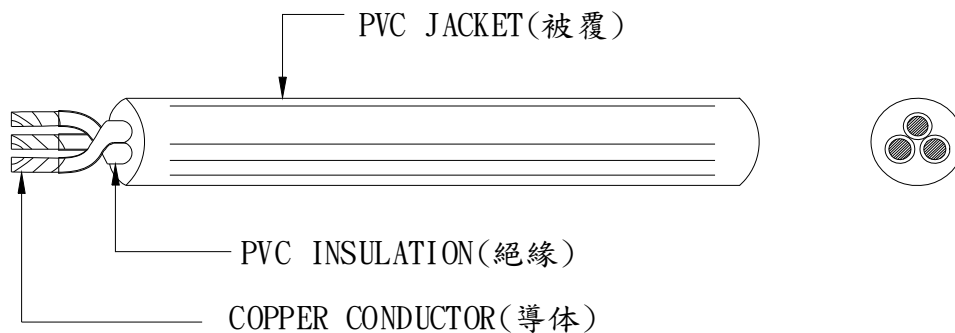



Yung Li Co., Ltd.
Da Pu Industrial Zone
Chang Ping Town
CN-Dongguan, Guangdong 523571
P.R. China

Client no.
125389

Your ref.
Robert Yung Li

Our Ref.
Gn

Date
2012/05/21

Authorization

Number: **12.0353**
valid until: **2015/05/20**

Marking:  Company Logo

Based on the documents contained in file **11-IK-0683** the Federal Inspectorate for Heavy Current Installations grants the firm named above the right, to put the equipment listed below on the market marked with the safety mark in accordance with the NEV.

Equipment: **Plug, non-rewirable**
Tradename: **YUNG LI**

Type designation: **YP-46**
Nominal values:
250V~ 10A L+N+PE
plug CH-type 12, standard sheet SEV 6534-2
with non-rewirable cords:
H05VV-F 3G0.75mm² [YUNG LI]
H05VV-F 3G1.00mm² [YUNG LI]
H05VV-F 3G1.50mm² [YUNG LI]

Protection class: for class I equipment
Protection degree: ordinary
Basis: Certificate / electrosuisse / IK-1925 dated 2012/05/15
Remark:
Test standards: IEC 60884-1(ed.3):02+A1:06
SEV 1011:09





Authorization

Number: **12.0353**

Page **2**

Federal Inspectorate for Heavy Current Installations ESTI

P. Fluri
Head of Market Surveillance/Authorization of the Safety Mark

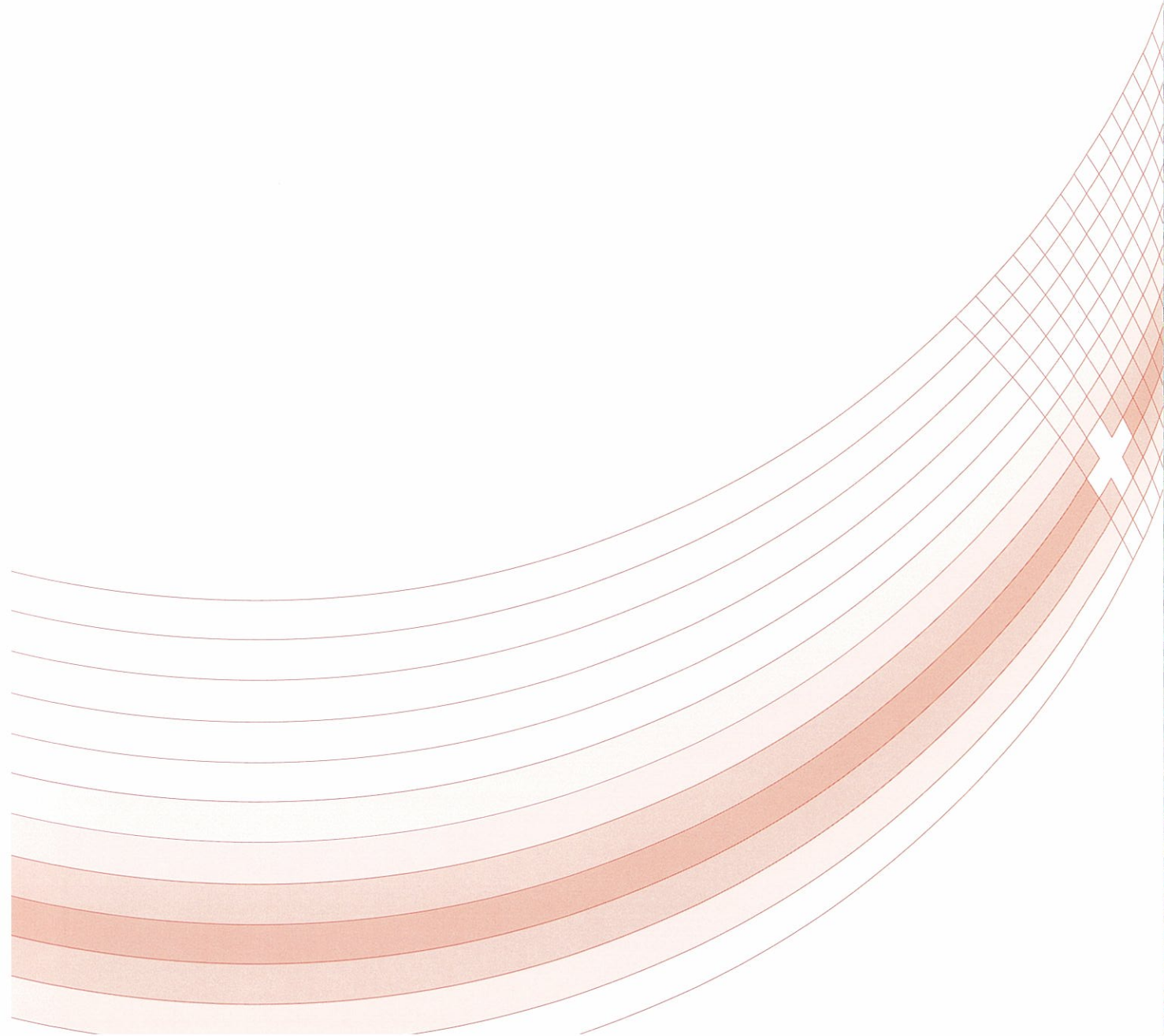

VDE Prüf- und Zertifizierungsinstitut

ZEICHENGENEHMIGUNG MARKS APPROVAL

Yung-Li Co. Ltd.
Da Pu Industrial Zone
Chang Ping Town
523571 DONG GUAN CITY
Guangdong
CHINA

ist berechtigt, für ihr Produkt /
Is authorized to use for their product

Gerätesteckdose, nicht-wiederanschließbar
Connector, non-rewirable

die hier abgebildeten markenrechtlich geschützten Zeichen
für die ab Blatt 2 aufgeführten Typen zu benutzen /
the legally protected Marks as shown below for the types referred to on page 2 ff.



Geprüft und zertifiziert nach /
Tested and certified according to

DIN EN 60320-1 (VDE 0625-1):2008-05; EN 60320-1:2001 + A1:2007



VDE Prüf- und Zertifizierungsinstitut GmbH
VDE Testing and Certification Institute
Zertifizierungsstelle / Certification

Aktenzeichen: 1609800-1550-0003 / 116615

File ref.:

Ausweis-Nr. 40029577

Blatt 1

Certificate No.

Page

Weitere Bedingungen: siehe Rückseite und Folgebilder /
further conditions see overleaf and following pages

Offenbach, 2010-03-05

VDE Zertifikate sind nur gültig bei Veröffentlichung unter:
VDE certificates are valid only when published on:

<http://www.vde.com/zertifikat>
<http://www.vde.com/certificate>

VDE



VDE Prüf- und Zertifizierungsinstitut

Zeichengenehmigung

Ausweis-Nr. / Blatt /
Certificate No. page
40029577 2

Name und Sitz des Genehmigungs-Inhabers / *Name and registered seat of the Certificate holder*
Yung-Li Co. Ltd., Da Pu Industrial Zone, Chang Ping Town, 523571 DONG GUAN CITY, Guangdong,
CHINA

Aktenzeichen / *File ref.*
1609800-1550-0003 / 116615 / FG31 / E

Datum / *Date*
2010-03-05

Dieses Blatt gilt nur in Verbindung mit Blatt 1 des Zeichengenehmigungsausweises Nr. 40029577.
This supplement is only valid in conjunction with page 1 of the Certificate No. 40029577.

Gerätesteckdose, nicht-wiederanschließbar *Connector, non-rewirable*

Typ(en) / *Type(s)*:

- 1) YC-12
- 2) YC-12L

Bemessungsspannung
Rated voltage AC 250 V

Bemessungsstrom
Rated current 10 A

Polzahl
Number of poles 2-polig mit Schutzkontakt
2-pole with earthing contact

Bauart
Kind of construction Normblatt C13
standard sheet C13

Warenzeicheninhaber
Trademark holder Yung Li Co. Ltd.

Produktinformation
Product information siehe Anlage Nr. 300 + 400 + 900
see Appendix No. 300 + 400 + 900

PAK Das Produkt entspricht den Anforderungen gemäß PAK-Dokument
ZEK 01.2-08.

PAH *The product is in accordance with the requirements of*
PAH-document ZEK 01.2-08.

Fortsetzung siehe Blatt 3 /
continued on page 3

VDE Prüf- und Zertifizierungsinstitut GmbH * Testing and Certification Institute



DEPARTMENT OF **FAIR TRADING**
NSW Consumer Protection Agency

Certificate Number: 17665

CERTIFICATE OF APPROVAL

ISSUED PURSUANT TO SECTION 21C OF THE ELECTRICITY SAFETY ACT 1945

ISSUED TO:

Yung Li Co Ltd

CLASS OF ARTICLE:

Appliance Connector

DESCRIPTION OF ARTICLE:

Appliance Connector
(Side-entry, C13 appliance connector, for cold conditions, for Class I equipment,
integrally moulded to any <HAR> certified H05VV-F 3G1.0mm², or Australian
approved three-core 1.00 mm², PVC insulated and sheathed ordinary duty
circular flexible cord)
Trade Name: 'Yung Li'
250V, ac, 10A

EXAMINED FOR COMPLIANCE WITH: AS/NZS 3109.1 : 1996 A1

TYPE REFERENCE CODE: Model No. YC-12L

APPROVAL MARK:

Each electrical article of the abovementioned type shall be marked with Approval Number
N17665

DATE OF APPROVAL: 30 April 2001

This approval expires 30 April 2006 unless suspended, cancelled, renewed or extended.

for DIRECTOR-GENERAL

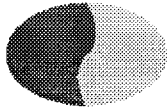

Ref: N17665/1

DEPARTMENT OF **FAIR TRADING**
NSW Consumer Protection Agency

ADDENDUM TO CERTIFICATE OF APPROVAL No 17665

Particulars of Modification(s)

Original Model No. YC-12L alternatively moulded to any <HAR> certified H05VV-F 3G0.75mm², or Australian approved three-core, 0.75mm², PVC insulated and sheathed ordinary duty circular flexible cord not exceeding two metres in length.

Approved: 30 April 2001

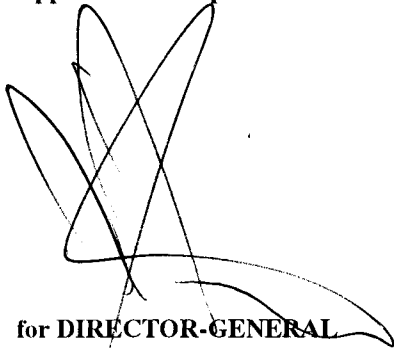

for DIRECTOR-GENERAL

Ref: 17665/2

ADDENDUM TO CERTIFICATE OF APPROVAL 17665

Particulars of Modification(s)

1. **Model No. YC-12L alternatively moulded to any <HAR> certified H05VV-F 3G1.5mm² or equivalent Australian approved three-core, 1.5mm², PVC insulated and sheathed ordinary duty circular flexible cord.**
2. **General Modification:
Model No. YC-12L now complies with AS/NZS 60320.1 : 2004.**

Approved: 21 March 2006



for Commissioner for Fair Trading

Ref: 17665/3

RENEWAL OF CERTIFICATE OF APPROVAL 17665

PARTICULARS OF RENEWAL

The approval of Appliance Connector Model No. YC-12L and approved modifications has been renewed for a period of FIVE years.

Date of Renewal: 27 April 2006

The Approval expires on 30 April 2011 unless it is renewed, extended, suspended or cancelled.

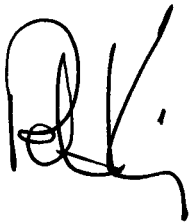
A handwritten signature in black ink, appearing to be 'R.K.', written in a cursive style.

for Commissioner for Fair Trading

Ref: NSW17665/4

RENEWAL OF CERTIFICATE OF APPROVAL NSW17665

PARTICULARS OF RENEWAL

The approval of Appliance Connector Model No. YC-12L and approved modifications has been renewed for a period of FIVE years.

The Approval expires on 30/04/2016 unless it is renewed, extended, suspended or cancelled.



for Deputy Commissioner, Fair Trading Operations

ZEICHENGENEHMIGUNG MARKS APPROVAL

Yung-Li Co. Ltd.
Da Pu Industrial Zone, Cang Zi
Chang Ping Town
523571 DONG GUAN CITY
Guangdong
CHINA

ist berechtigt, für ihr Produkt /
is authorized to use for their product

Starkstromleitungen für allgemeine Anwendungen
- Flexible Leitungen
mit thermoplastischer PVC-Isolierung
Cables for general applications
- *Flexible cables with*
thermoplastic PVC insulation

die hier abgebildeten markenrechtlich geschützten Zeichen
für die ab Blatt 2 aufgeführten Typen zu benutzen /
the legally protected Marks as shown below for the types referred to on page 2 ff.



oder/or



oder/or



schwarz
black

rot
red

Geprüft und zertifiziert nach /
Tested and certified according to

DIN EN 50525-2-11 (VDE 0285-525-2-11):2012-01; EN 50525-2-11:2011



VDE Prüf- und Zertifizierungsinstitut GmbH
VDE Testing and Certification Institute
Zertifizierungsstelle / *Certification*

K. Prohaska

Aktenzeichen: 1609800-5140-0005 / 171941
File ref.:

Ausweis-Nr. 40010145 Blatt 1
Certificate No. Page

Weitere Bedingungen siehe Rückseite und Folgeblätter /
further conditions see overleaf and following pages

Offenbach, 2004-04-27
(letzte Änderung/updated 2012-09-25)

VDE Zertifikate sind nur gültig bei Veröffentlichung unter:
VDE certificates are valid only when published on:

<http://www.vde.com/zertifikat>
<http://www.vde.com/certificate>

Name und Sitz des Genehmigungs-Inhabers / *Name and registered seat of the Certificate holder*
Yung-Li Co. Ltd., Da Pu Industrial Zone, Cang Zi, Chang Ping Town, 523571 DONG GUAN CITY,
Guangdong, CHINA

Aktenzeichen / *File ref.*
1609800-5140-0005 / 171941 / FG42 / HEG

letzte Änderung / *updated* Datum / *Date*
2012-09-25 2004-04-27

Dieses Blatt gilt nur in Verbindung mit Blatt 1 des Zeichengenehmigungsausweises Nr. 40010145
This supplement is only valid in conjunction with page 1 of the Certificate No. 40010145.

Starkstromleitungen für allgemeine Anwendungen
- Flexible Leitungen
mit thermoplastischer PVC-Isolierung
Cables for general applications
- Flexible cables with
thermoplastic PVC insulation

Typ(en) / *Type(s)*:

H03VV-F 2...4 x 0,5...0,75 mm ²	+
H03VVH2-F 2 x 0,5...0,75 mm ²	+
H05VV-F 2...5 x 0,75...4 mm ²	+
H05VVH2-F 2 x 0,75...1,0 mm ²	+

Leitungsbauart <i>Type of cable</i>	Standardleitungen <i>General purpose cables</i>
--	--

Firmenzeichen <i>Trademark</i>	YUNG LI
-----------------------------------	---------

Dieser Zeichengenehmigungs-Ausweis bildet eine Grundlage für die EG-Konformitätserklärung und CE-Kennzeichnung durch den Hersteller oder dessen Bevollmächtigten und bescheinigt die Konformität mit den grundlegenden Schutzanforderungen der **EG-Niederspannungsrichtlinie 2006/95/EG** mit ihren Änderungen.

This Marks Approval is a basis for the EC Declaration of Conformity and the CE Marking by the manufacturer or his agent and proves the conformity with the essential safety requirements of the EC Low-Voltage Directive 2006/95/EC including amendments.

VDE Prüf- und Zertifizierungsinstitut GmbH
VDE Testing and Certification Institute
Fachgebiet FG42
Section FG42

Name und Sitz des Genehmigungs-Inhabers / *Name and registered seat of the Certificate holder*
Yung-Li Co. Ltd., Da Pu Industrial Zone, Cang Zi, Chang Ping Town, 523571 DONG GUAN CITY,
Guangdong, CHINA

Aktenzeichen / *File ref.*
1609800-5140-0005 / 171941 / FG42 / HEG

letzte Änderung / *updated* Datum / *Date*
2012-09-25 2004-04-27

Dieses Beiblatt ist Bestandteil des Zeichengenehmigungsausweises Nr. 40010145.
This supplement is part of the Certificate No. 40010145.

Starkstromleitungen für allgemeine Anwendungen
- Flexible Leitungen
mit thermoplastischer PVC-Isolierung
Cables for general applications
- Flexible cables with
thermoplastic PVC insulation

Fertigungsstätte(n)
Place(s) of manufacture

Referenz/*Reference* Yung-Li Co. Ltd.
30008928 Da Pu Industrial Zone, Cang Zi
 Chang Ping Town
 523571 DONG GUAN CITY
 Guangdong
 CHINA

VDE Prüf- und Zertifizierungsinstitut GmbH
VDE Testing and Certification Institute
Fachgebiet FG42
Section FG42

VDE Prüf- und Zertifizierungsinstitut

Zeichengenehmigung

Ausweis-Nr. / Infoblatt /
Certificate No. Info sheet
40010145

Name und Sitz des Genehmigungs-Inhabers / *Name and registered seat of the Certificate holder*

Yung-Li Co. Ltd., Da Pu Industrial Zone, Cang Zi, Chang Ping Town, 523571 DONG GUAN CITY,
Guangdong, CHINA

Aktenzeichen / *File ref.*

1609800-5140-0005 / 171941 / FG42 / HEG

letzte Änderung / *updated* Datum / *Date*

2012-09-25 2004-04-27

Dieses Blatt gilt nur in Verbindung mit Blatt 1 des Zeichengenehmigungsausweises Nr. 40010145
This supplement is only valid in conjunction with page 1 of the Certificate No. 40010145.

Genehmigung zum Benutzen des auf Seite 1 abgebildeten markenrechtlich geschützten Zeichens des VDE:

Grundlage für die Benutzung sind die Allgemeinen Geschäftsbedingungen (AGB) der VDE Prüf- und Zertifizierungsinstitut GmbH (www.vde.com\AGB-Institut). Das Recht zur Benutzung erstreckt sich nur auf die bezeichnete Firma mit den genannten Fertigungsstätten und die oben aufgeführten Produkte mit den zugeordneten Bezeichnungen. Die Fertigungsstätte muss so eingerichtet sein, dass eine gleichmäßige Herstellung der geprüften und zertifizierten Ausführung gewährleistet ist.

Die Genehmigung ist so lange gültig wie die VDE-Bestimmungen gelten, die der Zertifizierung zugrunde gelegen haben, sofern sie nicht auf Grund anderer Bedingungen aus der VDE Prüf- und Zertifizierungsordnung (PM102) zurückgezogen werden muss.

Der Gültigkeitszeitraum einer VDE-GS-Zeichengenehmigung kann auf Antrag verlängert werden. Bei gesetzlichen und / oder normativen Änderungen kann die VDE-GS-Zeichengenehmigung ihre Gültigkeit zu einem früheren als dem angegebenen Datum verlieren.

Produkte, die das Biozid Dimethylfumarat (DMF) enthalten, dürfen gemäß der Kommissionsentscheidung 2009/251/EG nicht mehr in den Verkehr gebracht oder auf dem Markt bereitgestellt werden.

Der VDE-Zeichengenehmigungsausweis wird ausschließlich auf der ersten Seite unterzeichnet.

Approval to use the legally protected Mark of the VDE as shown on the first page:

Basis for the use are the general terms and conditions of the VDE Testing and Certification Institute (www.vde.com\terms-institute). The right to use the mark is granted only to the mentioned company with the named places of manufacture and the listed products with the related type references. The place of manufacture shall be equipped in a way that a constant manufacturing of the certified construction is assured.

The approval is valid as long as the VDE specifications are in force, on which the certification is based on, unless it is withdrawn according to the VDE Testing and Certification Procedure (PM102E).

The validity period of a VDE-GS-Mark Approval may be prolonged on request. In case of changes in legal and / or normative requirements, the validity period of a VDE-GS-Mark Approval may be shortened.

Products containing the biocide dimethylfumarate (DMF) may not be marketed or made available on the EC market according to the Commission Decision 2009/251/EC.

The approval is solely signed on the first page.